

MAINTAINANCE AND WARNING

- Keep furniture away from heat.
- Do not clean furniture with harsh cleansers or polish. Do not use detergents, Solvents, abrasives, spray packs or leather cleaner. Use non-color mild soap with warm water clean spills(Mix 1:10 soap to water)
- Do not place furniture under direct sunlight, material will possibly fade over time.
- Do not use on site dry Cleaning machine.
- Children should not climb or jump on the furniture.
- Do not write on furniture without a padded barrier to protect the surface.
- Not for commercial use, For residential use only.



Weight Limitation

250LBS

PARTS LIST

A*1

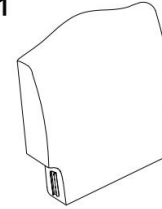

Back

B*1

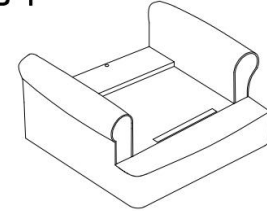

Seat Frame

C*1

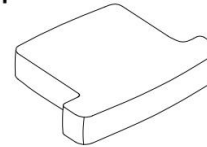

Seat Cushion

D*2



Front Legs

E*2



Back Legs

Persons Required For Assembly:



HARDWARE LIST

①*8
M6*20mm



Bolt

②*1
M8*80mm



Bolt

③*1



Nut

④*2



Flat washer

⑤*1



Allen Key

SPARE

①*1
M6*20mm



Bolt

②*1
M8*80mm



Bolt

③*1



Flat washer

Be sure to check all packing material carefully for small parts, which may have come loose inside the carton during shipment.

ASSEMBLY INSTRUCTIONS

STEP 1

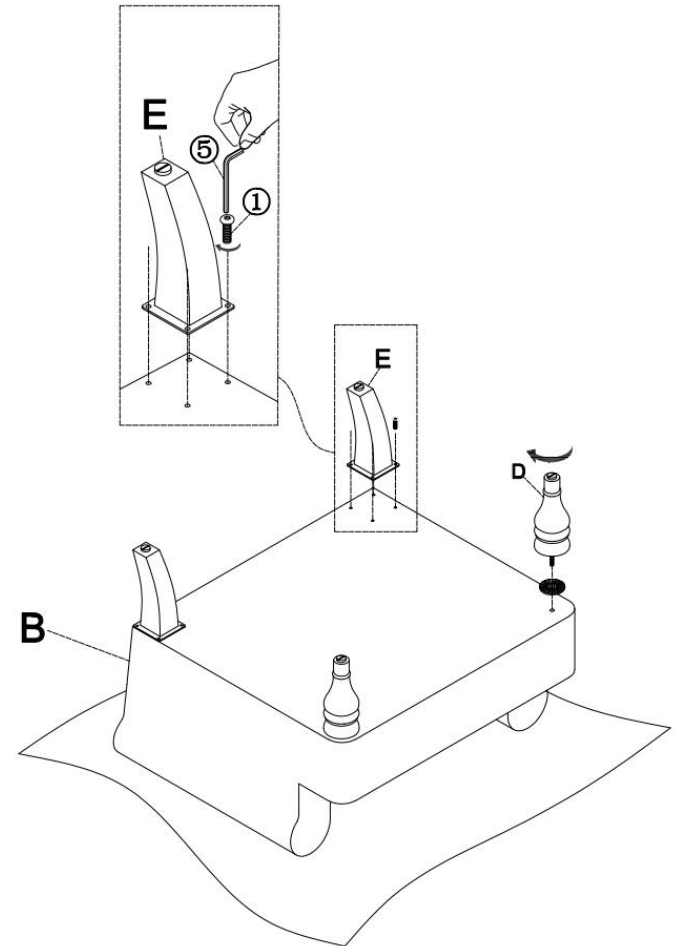

STEP 2

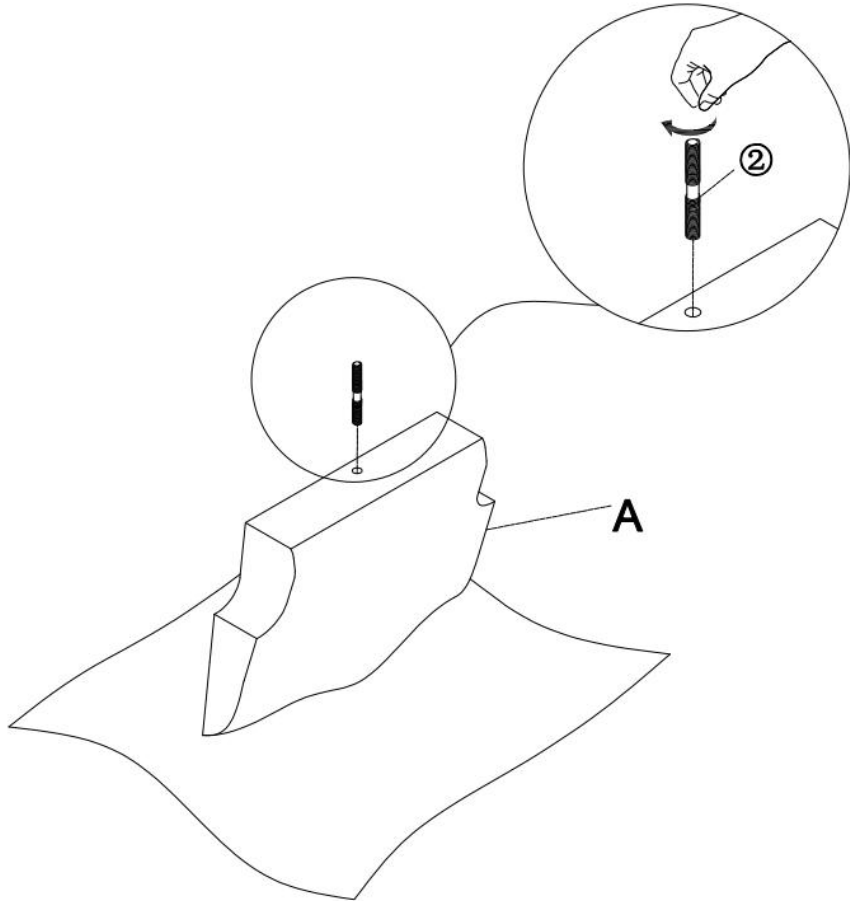

STEP 3

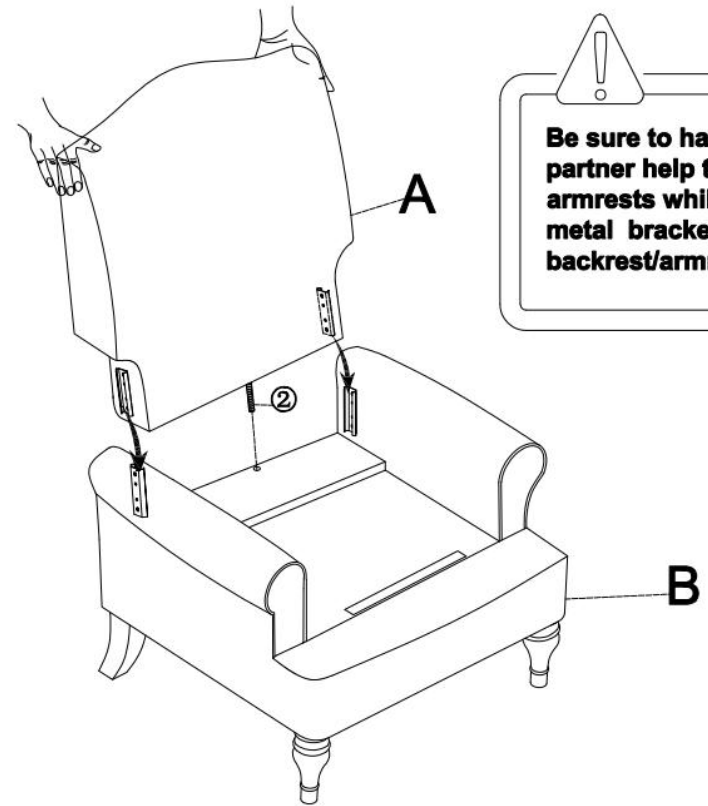

STEP 4

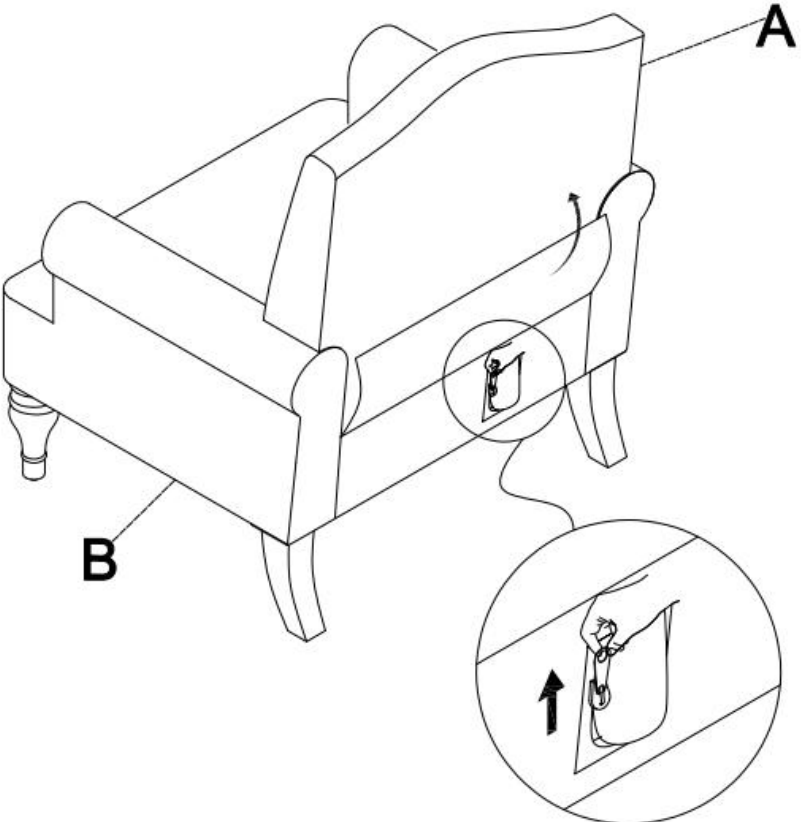

STEP 5

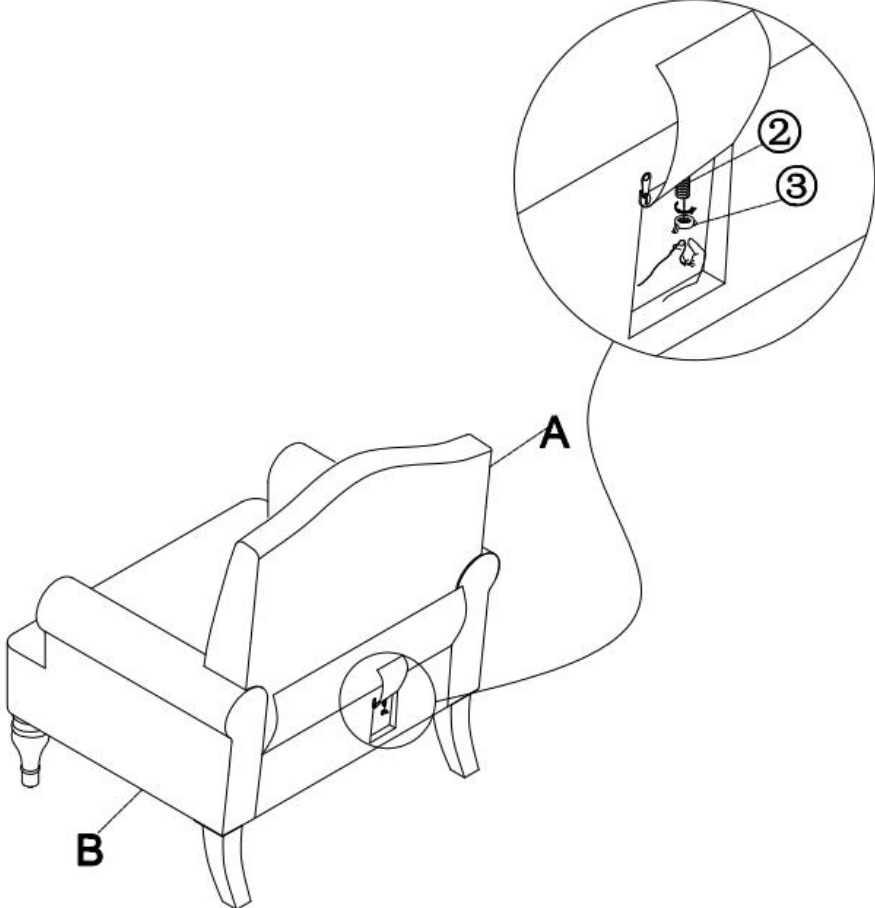

STEP 6

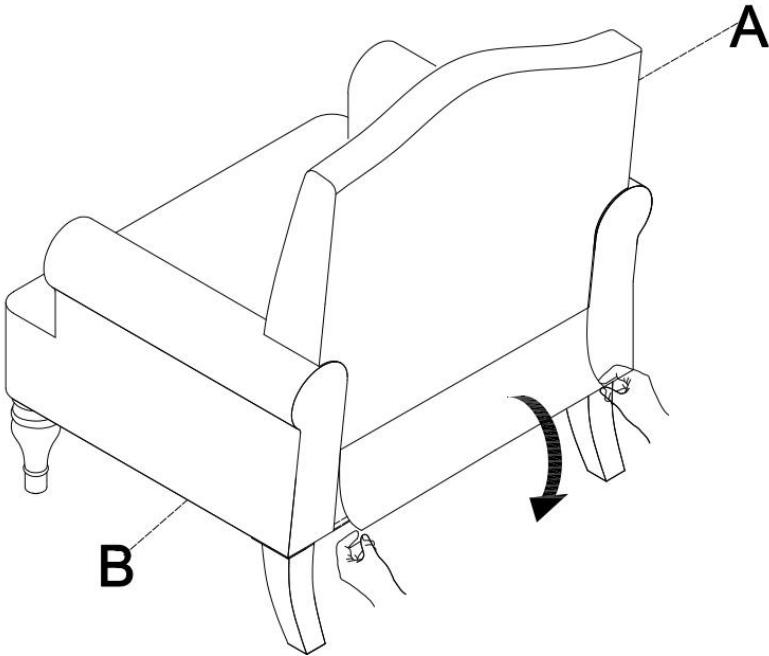

STEP 7

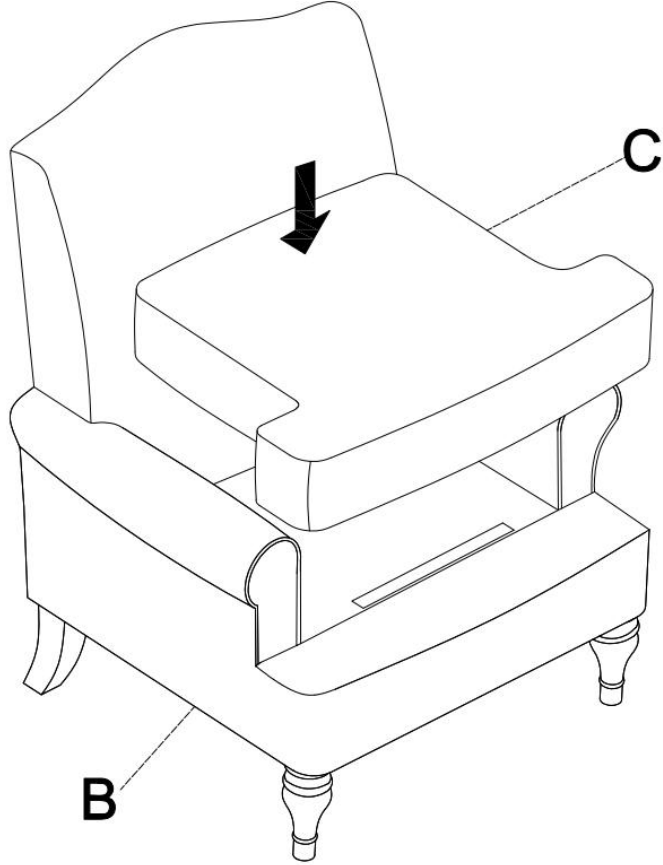

STEP 8



Attention:
After installation, adjust the adjustable leveler to keep the chair balanced .
Be sure to check all packing material carefully for small parts, which may have come loose inside the carton during shipment.

