

# Assembly Manual

## Armless Seat

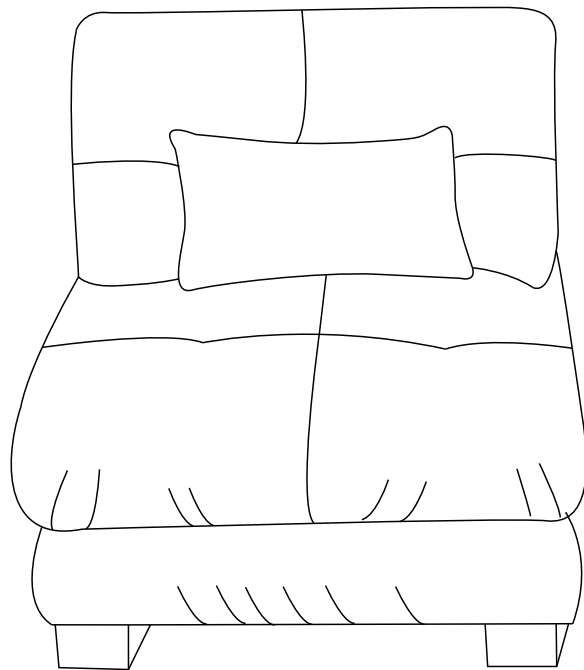





# Components List-Armless Seat

## Before Assembly

### IMPORTANT NOTE:

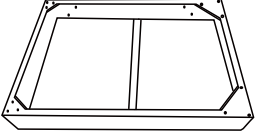
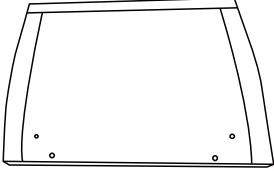
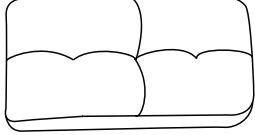
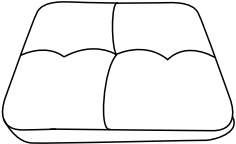
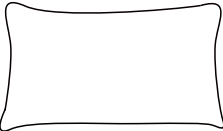
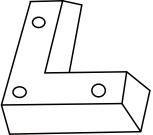
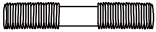
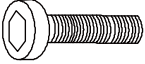
1. Make sure all parts and hardware are included and free of obvious defect before disposing of any packaging.
2. Place all wooden parts on a clean and smooth surface such as a rug or carpet to avoid the parts from being scratched.
3. Do not tighten all screws and bolts until completely assembled.
4. Assembly will require two people.

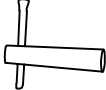
## Part List

<p><b>P.</b></p>  <p>Middle seat frame*1</p>	<p><b>Q</b></p>  <p>Small backrest*1</p>	<p><b>R</b></p>  <p>Middle back cushion*1</p>
<p><b>S</b></p>  <p>Middle seat cushion*1</p>	<p><b>H</b></p>  <p>Waist pillow*1</p>	<p><b>J</b></p>  <p>Leg*4</p>
<p><b>K</b></p>  <p>Bolt*4 M8*80mm</p>	<p><b>L</b></p>  <p>M6*50mm Bolt*12</p>	<p><b>M.</b></p>  <p>Washer*4</p>
<p><b>N</b></p>  <p>Allen key*1</p>	<p><b>O</b></p>  <p>Allen key*1</p>	

# Assembly Instruction-Armless Seat

Step 1

Assemble the leg (J) to the middle seat frame (P) with Bolts (L).

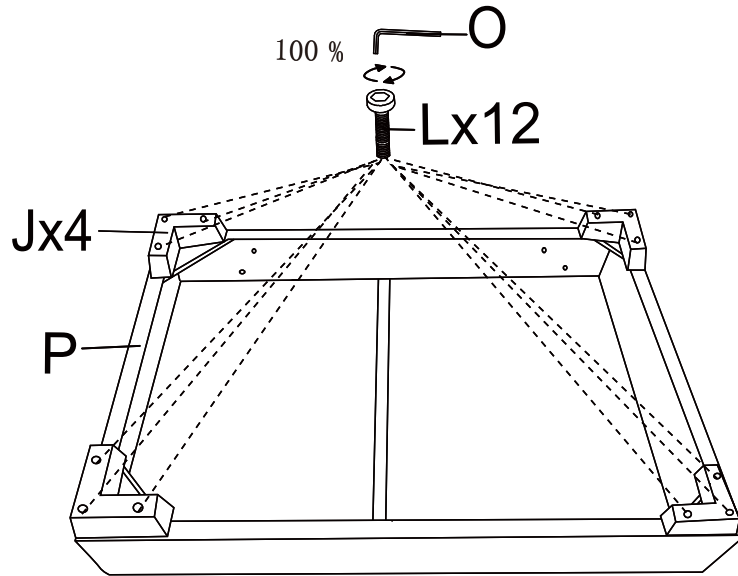

Step 2

Assemble the small backrest (Q) with Bolts (K)

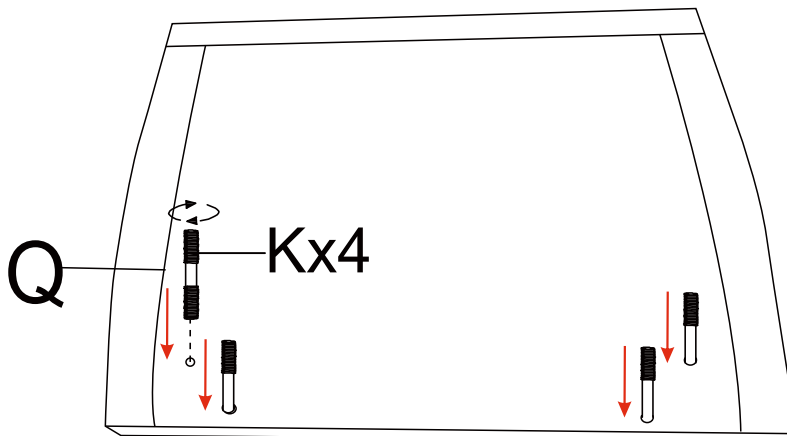

## Step 3

Assemble the small backrest(Q) to the middle seat frame(P) with washer (M).

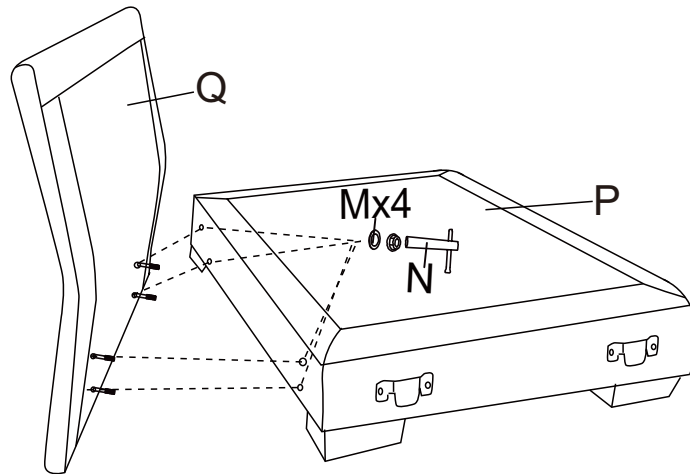

## Step 4

Put middle back cushion(R) and middle seat cushion(S) to the sofa.

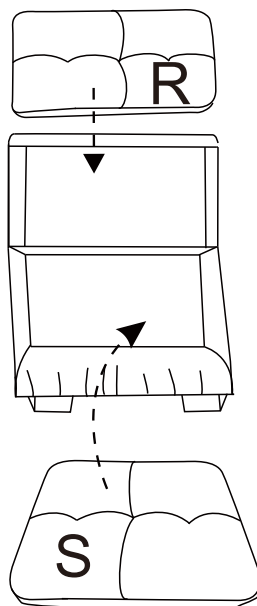

Step 5

Put waist pillow(H) to the sofa.

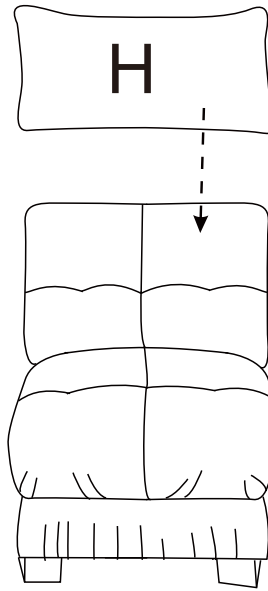

Step 6

Completed .

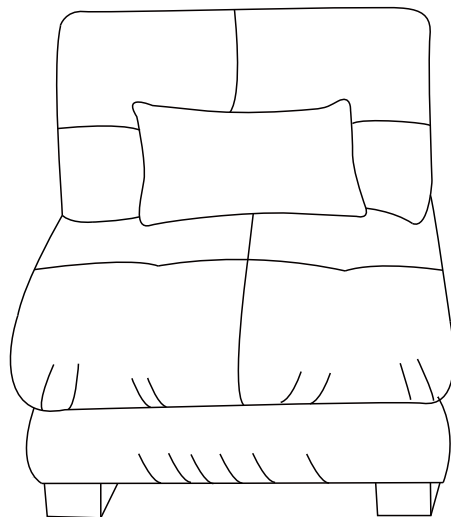

## Assembly Instruction

Please install according to the combination method purchased

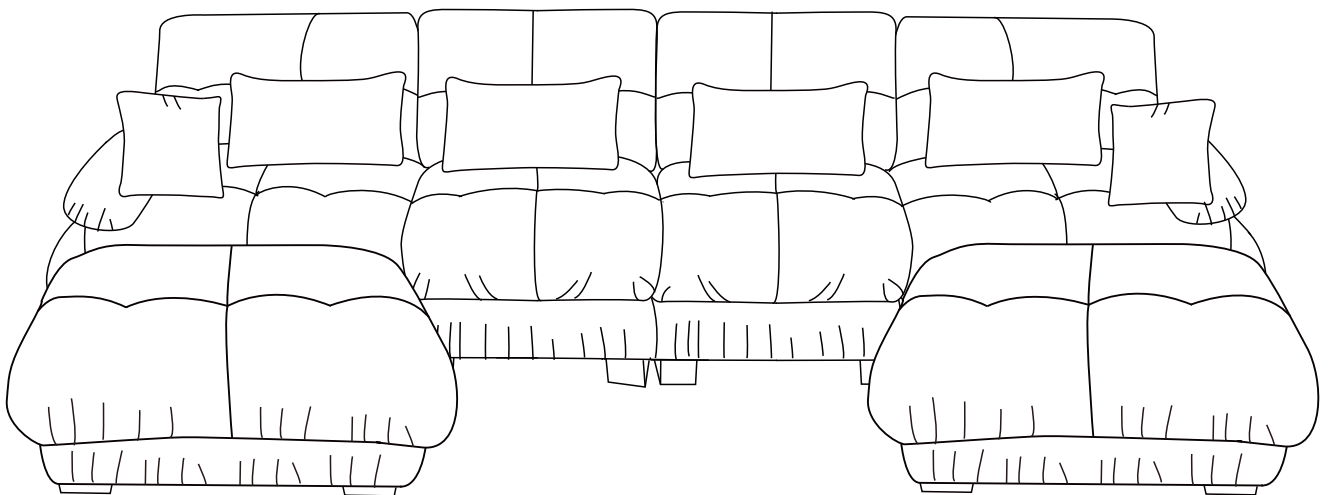
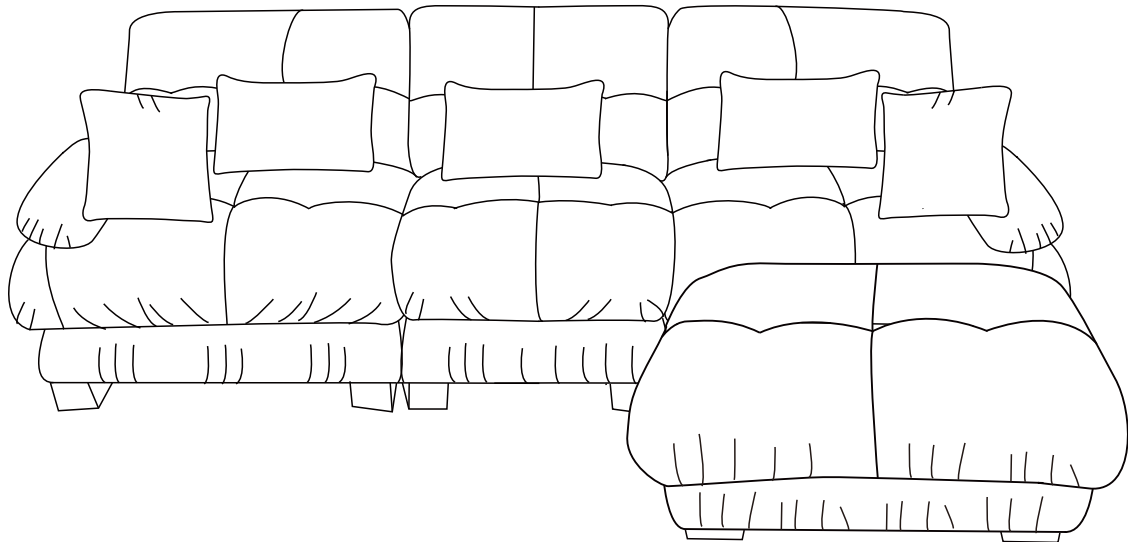

Note: Cushions are vacuum-packed & it may take approximately 72 hours to fully expand to their intended size & shape