

Assembly Manual

Armless Seat

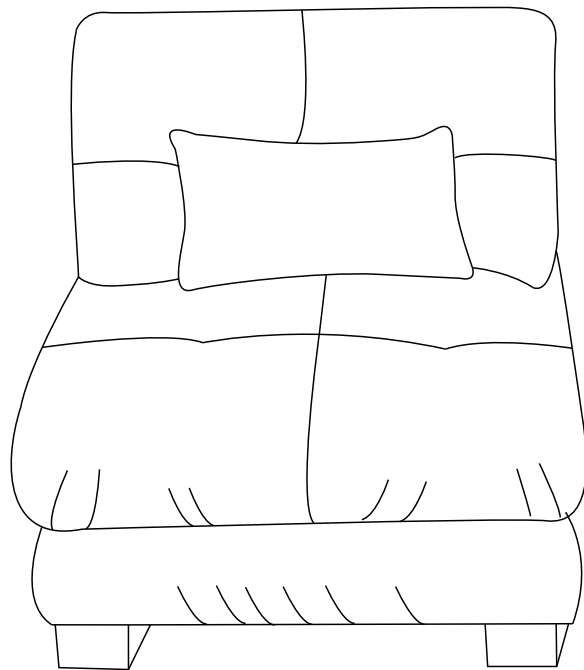





Components List-Armless Seat

Before Assembly

IMPORTANT NOTE:

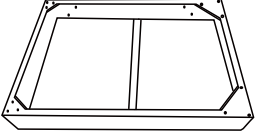
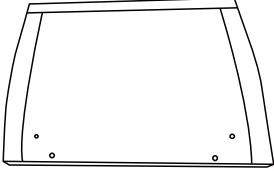
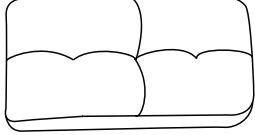
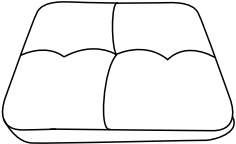
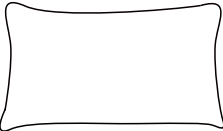
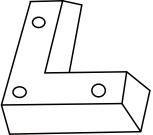
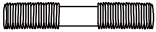
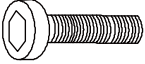
1. Make sure all parts and hardware are included and free of obvious defect before disposing of any packaging.
2. Place all wooden parts on a clean and smooth surface such as a rug or carpet to avoid the parts from being scratched.
3. Do not tighten all screws and bolts until completely assembled.
4. Assembly will require two people.

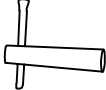
Part List

<p>P.</p>  <p>Middle seat frame*1</p>	<p>Q</p>  <p>Small backrest*1</p>	<p>R</p>  <p>Middle back cushion*1</p>
<p>S</p>  <p>Middle seat cushion*1</p>	<p>H</p>  <p>Waist pillow*1</p>	<p>J</p>  <p>Leg*4</p>
<p>K</p>  <p>Bolt*4 M8*80mm</p>	<p>L</p>  <p>M6*50mm Bolt*12</p>	<p>M.</p>  <p>Washer*4</p>
<p>N</p>  <p>Allen key*1</p>	<p>O</p>  <p>Allen key*1</p>	

Assembly Instruction-Armless Seat

Step 1

Assemble the leg (J) to the middle seat frame (P) with Bolts (L).

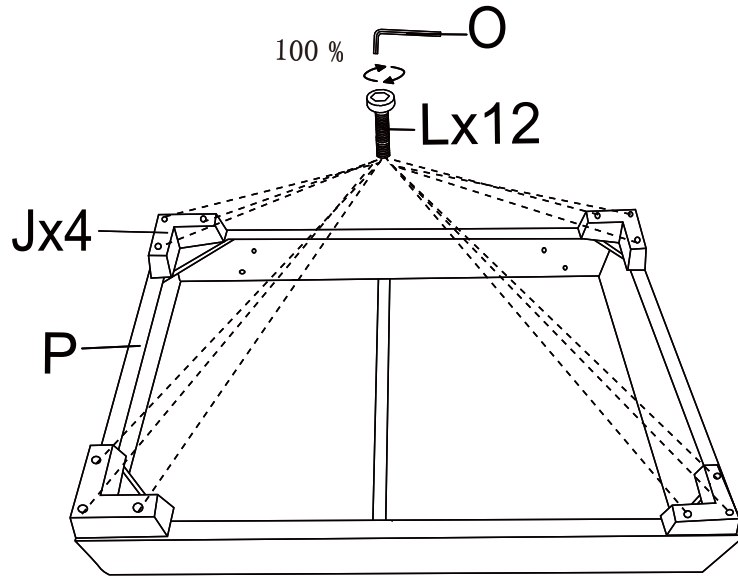

Step 2

Assemble the small backrest (Q) with Bolts (K)

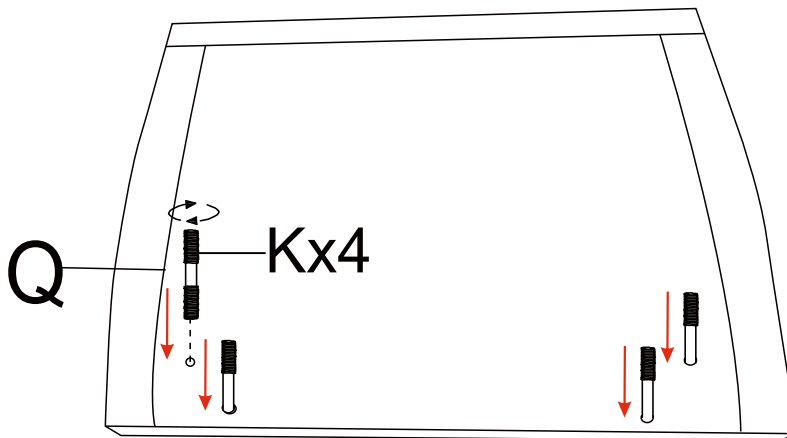

Step 3

Assemble the small backrest(Q) to the middle seat frame(P) with washer (M).

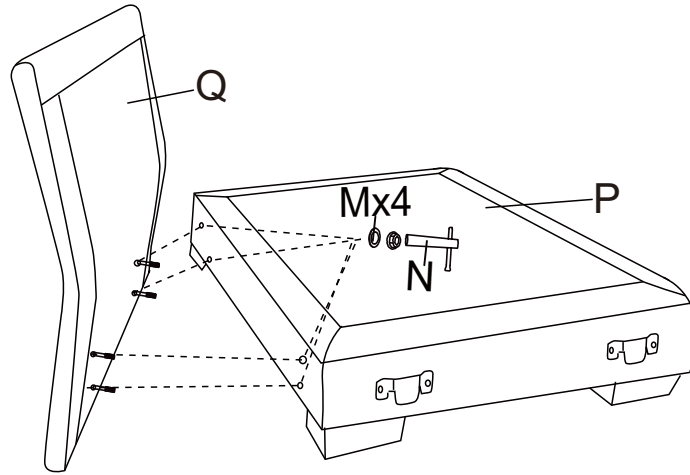

Step 4

Put middle back cushion(R) and middle seat cushion(S) to the sofa.

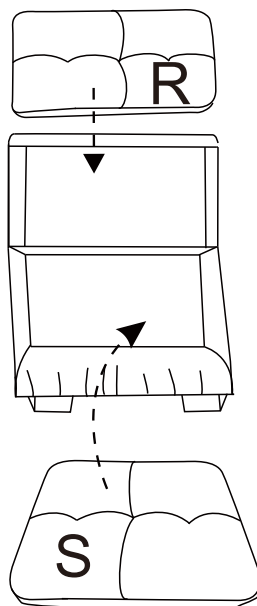

Step 5

Put waist pillow(H) to the sofa.

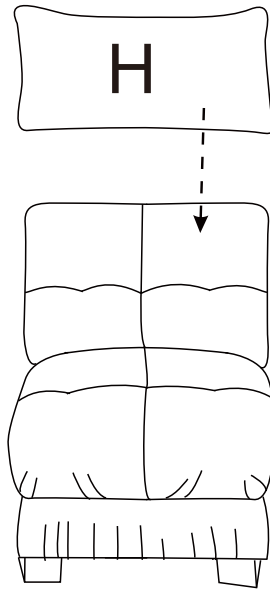

Step 6

Completed .

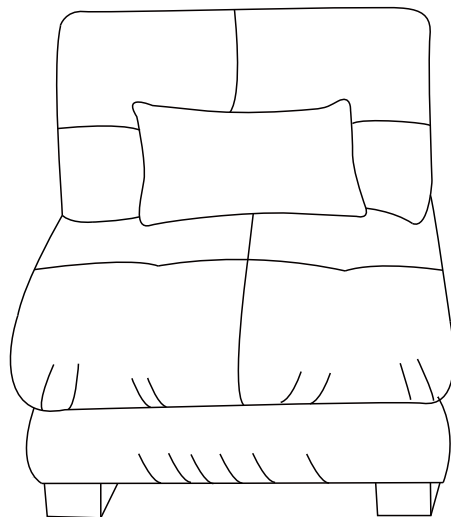

Assembly Instruction

Please install according to the combination method purchased

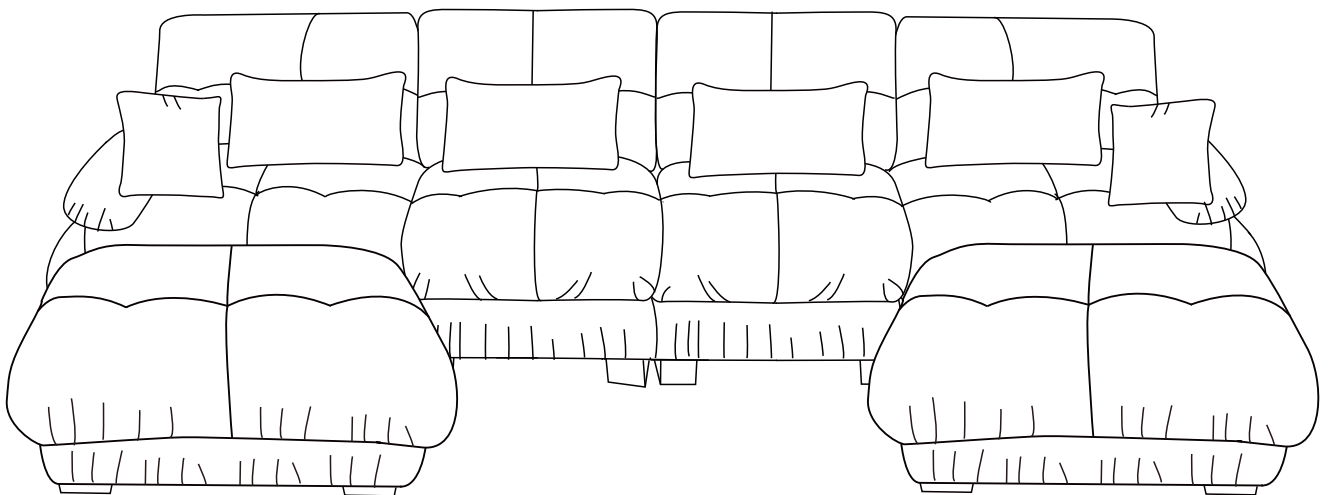
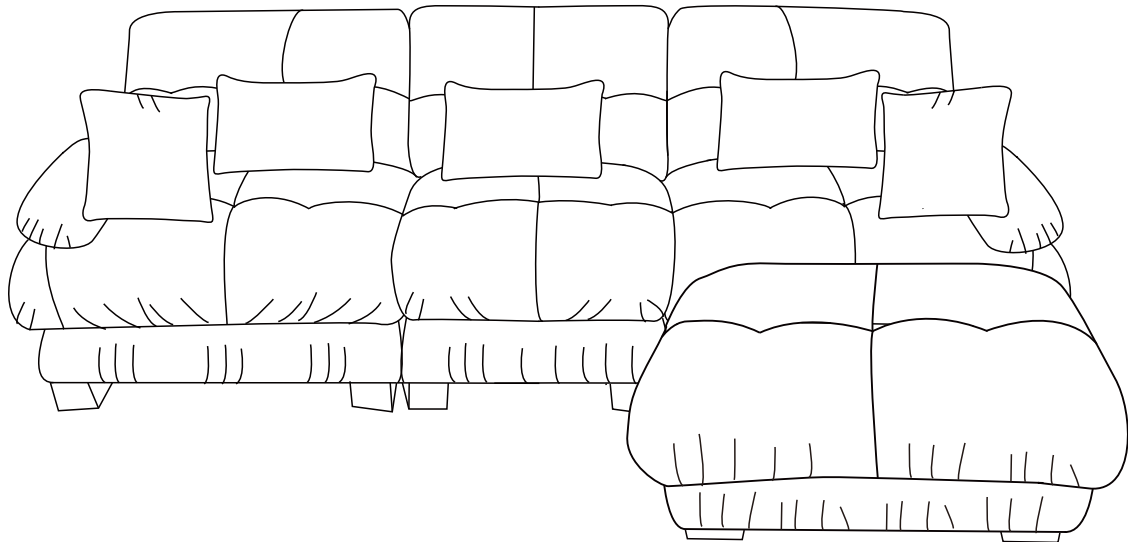

Note: Cushions are vacuum-packed & it may take approximately 72 hours to fully expand to their intended size & shape