

ARM CHAIR

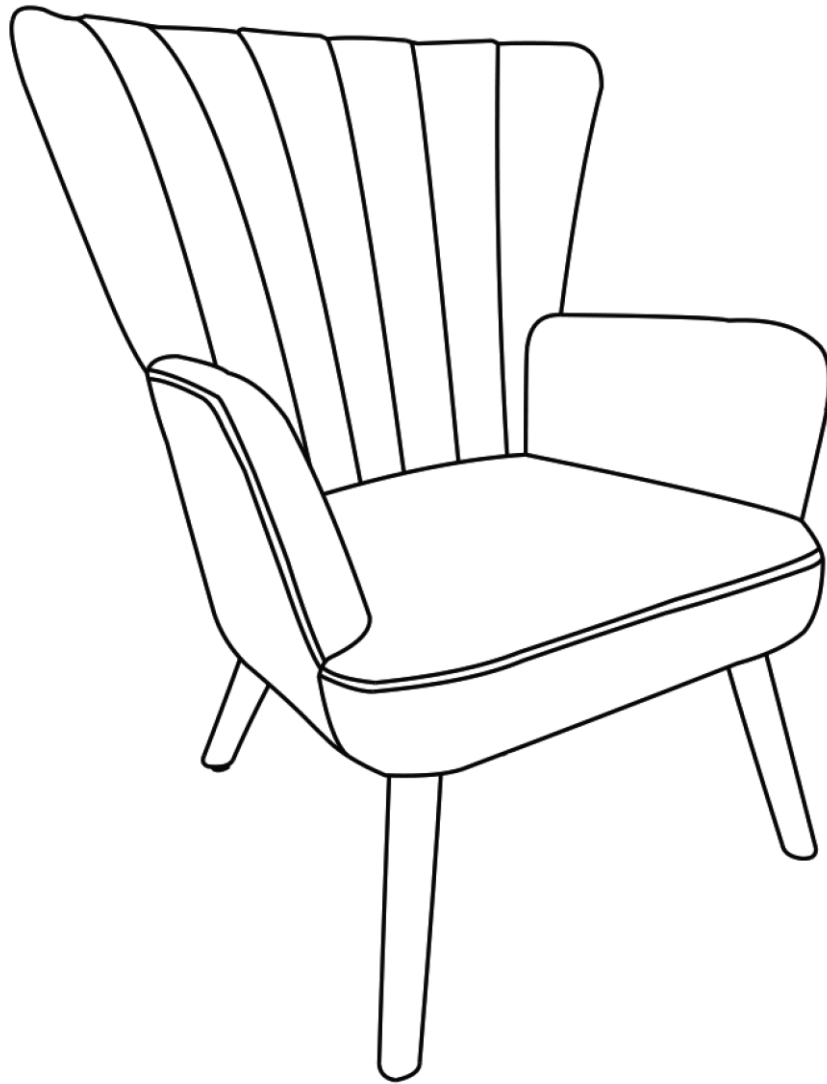





Before Assembly



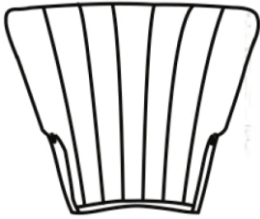

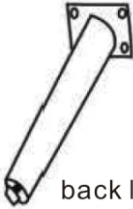
IMPORTANT NOTE:

1. Make sure all parts and hardware are included and free of obvious defect before disposing of any packaging.
2. Place all wooden parts on a clean and smooth surface such as a rug or carpet to avoid the parts from being scratched.
3. Do not tighten all screws and bolts until completely assembled.
4. Assembly will require two people.

Part List

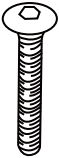
		 <p>back leg with adjustable screws</p>	
<p>① x1PC</p>	<p>② x1PC</p>	<p>③ x2PCS</p>	<p>④ x2PCS</p>

Hardware

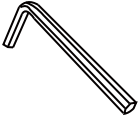
				
<p>A x2PCS</p>	<p>B x2PCS</p>	<p>C x2PCS</p>	<p>D x16PCS</p>	<p>E x1PC</p>

Step 1

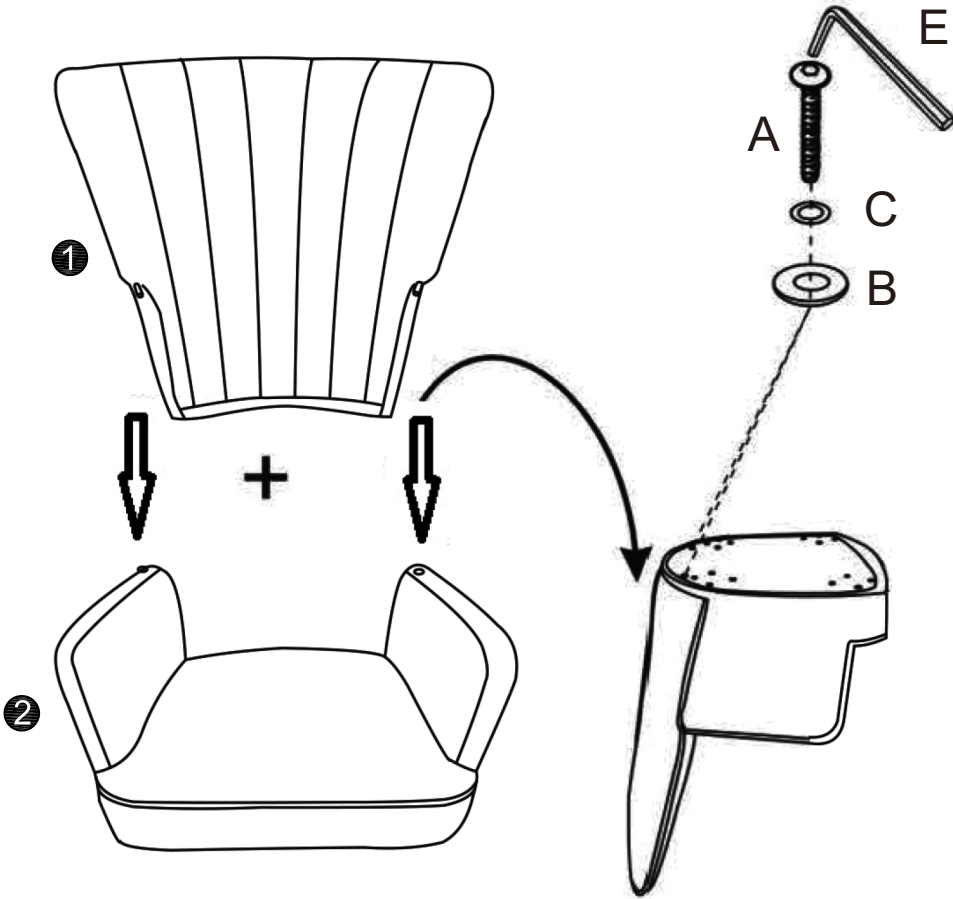

Step 2

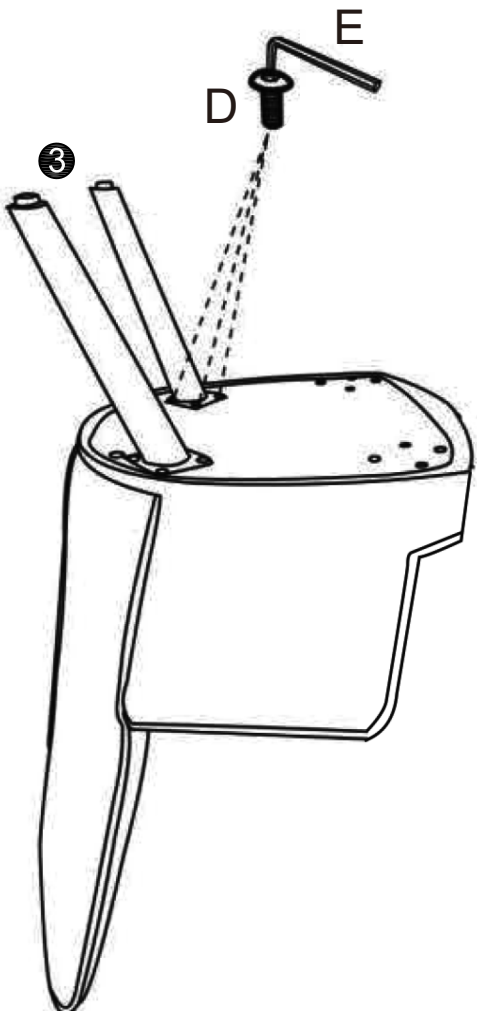

Step 3

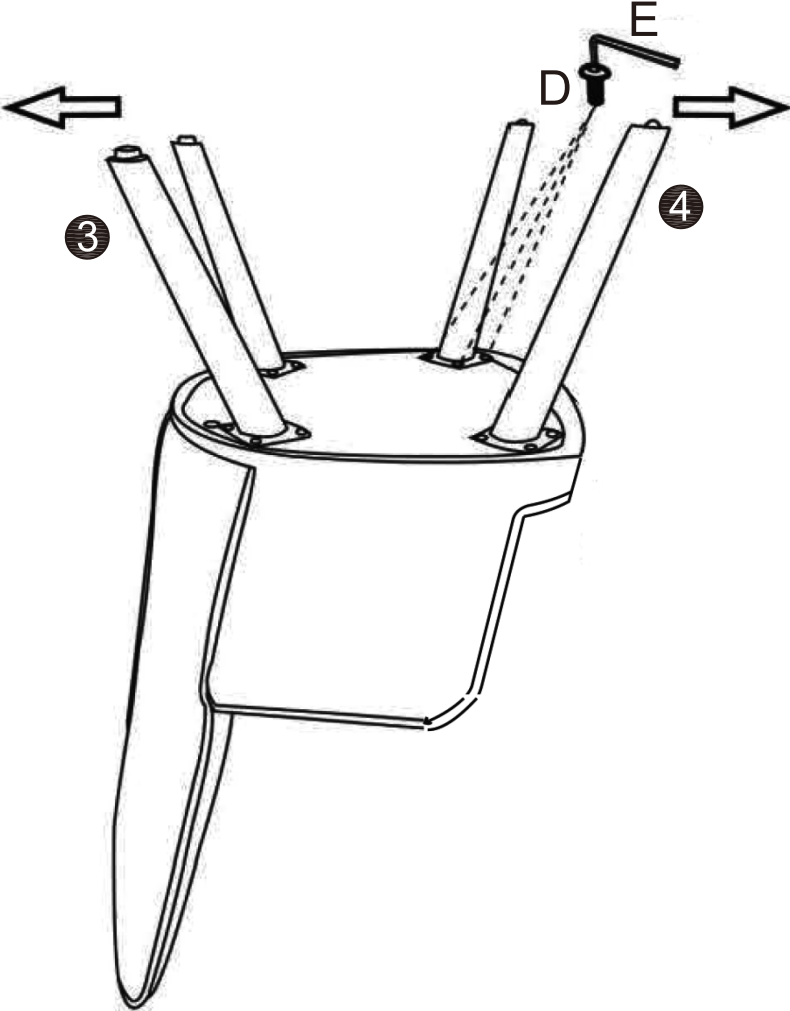

Step 4

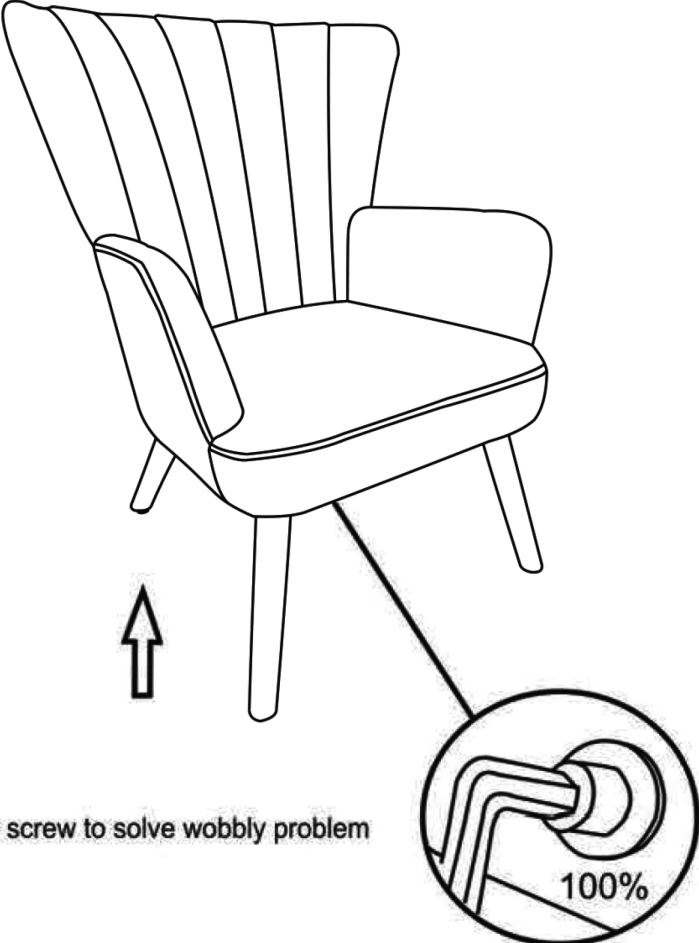

Adjust the screw to solve wobbly problem

100%