

6 Tier Bookshelf-Brown

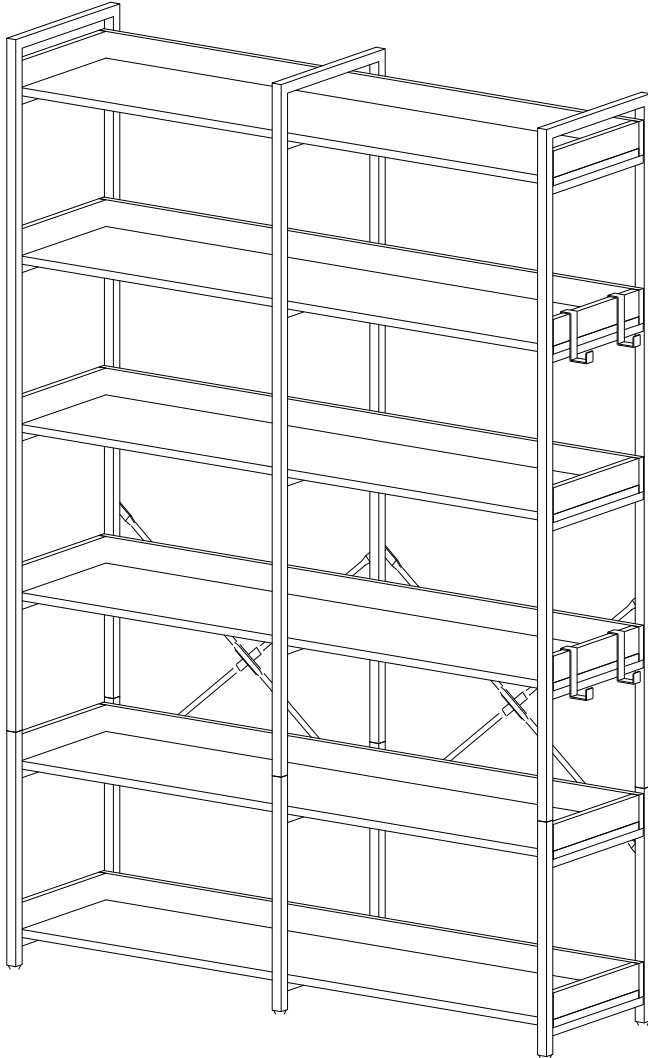

⚠ WARNING

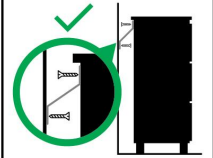

Children have died from furniture tipover.

- ALWAYS secure this furniture with an anchor device.
- NEVER allow children to stand, climb or hang on drawers, doors, or shelves.
- NEVER open more than one drawer at a time.
- Place heavy items down low.

NEVER put a TV on this furniture



This is a permanent label. Do not remove!

Customer Service Before Return:

If part is missing or damaged, or you need help with assembly please do not hesitate to contact us.

SELLER CONTACT INFORMATION:





cpcontacts@163.com

Before Assembly



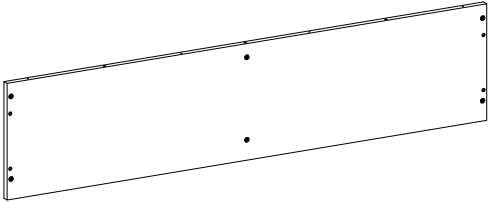
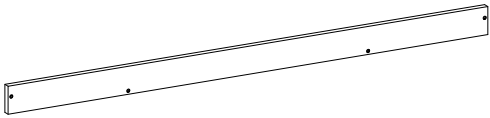

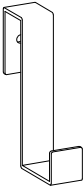
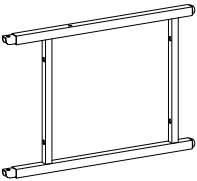
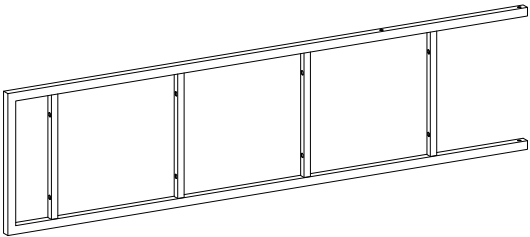



IMPORTANT NOTE:

- Make sure all parts and hardware are included and free of obvious defect before disposing of any packaging
- Place all wooden parts on a clean and smooth surface such as a rug or carpet to avoid the parts from being scratched.
- Do not tighten all screws and bolts until completely assembled.
- Assembly will require two people.

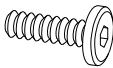
PART LIST

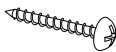
<p>1</p> 	<p>2</p> 
<p>6 PCS</p>	<p>6 PCS</p>
<p>3</p> 	<p>4</p> 
<p>12 PCS</p>	<p>4 PCS</p>
<p>6</p> 	<p>5</p> 
<p>3 PCS</p>	<p>3 PCS</p>
<p>7</p> 	<p>4 PCS</p>

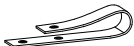
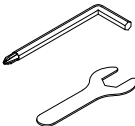
HARDWARE LIST

<p>A</p>  <p>M6x15mm</p>	<p>B</p>  <p>M6x25mm</p>	<p>C</p>  <p>M6x32mm</p>	<p>D</p>  <p>M6</p>	<p>E</p>  <p>4.0x35mm</p>
<p>8 PCS</p>	<p>36 PCS</p>	<p>6 PCS</p>	<p>8 PCS</p>	<p>48 PCS</p>
<p>F</p>  <p>5.0x30mm</p>	<p>G</p>  <p>Ø6x30mm</p>	<p>H</p> 	<p>I</p>  <p>ALLEN KEY</p>	<p>J</p> 
<p>2 PCS</p>	<p>2 PCS</p>	<p>2 PCS</p>	<p>1 PC</p>	<p>6 PCS</p>

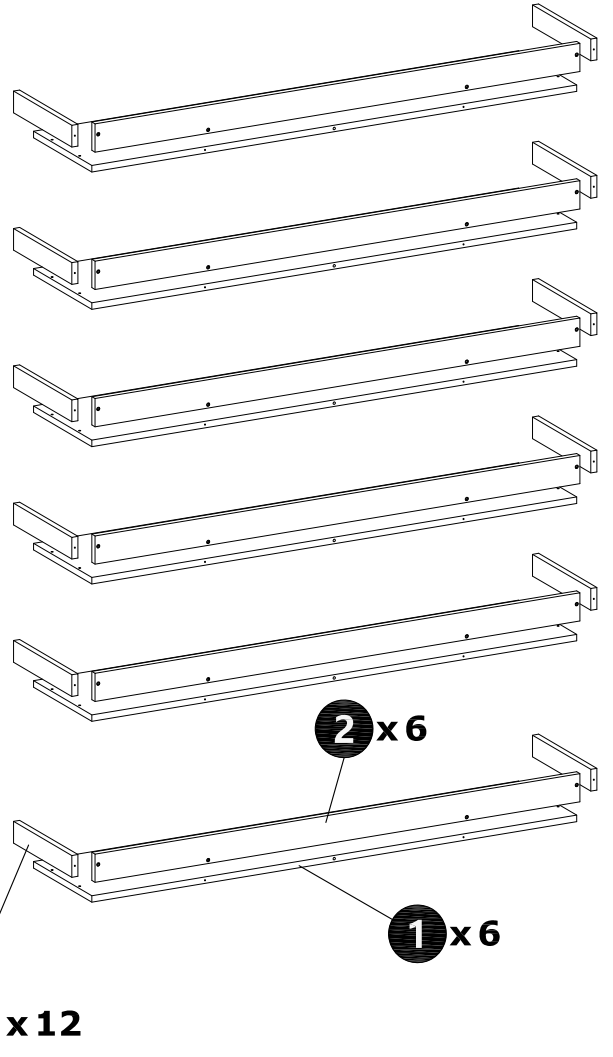
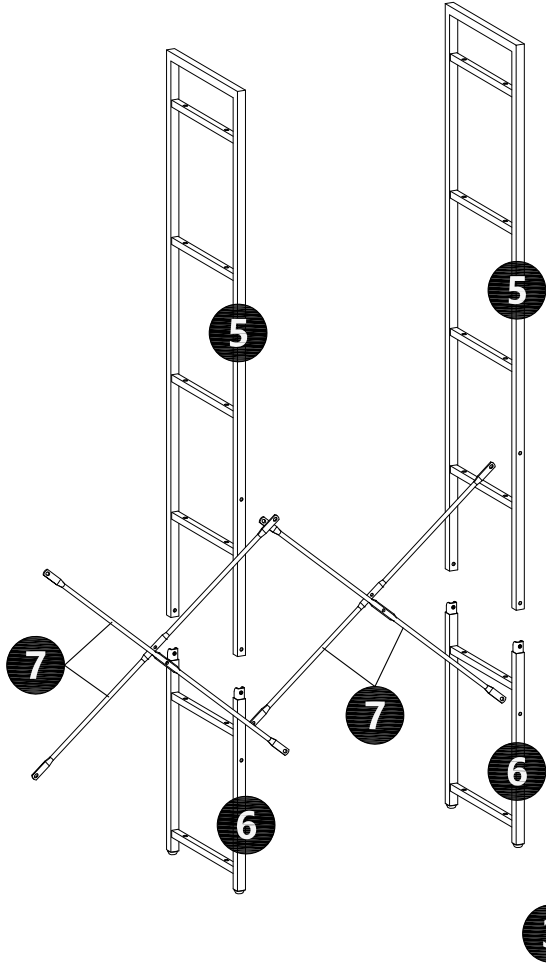
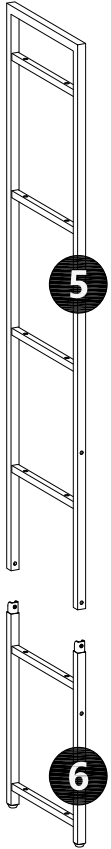
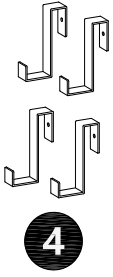

NOTED:

1. Do not fully tighten all bolts until all parts are in place. Failure to follow these instructions may cause the bolt to misalign during assembly.
2. To prevent injury and property damaged from unexpected tipping of furniture, we highly recommend installation of the anti-tip kit included with this product.

Step 1

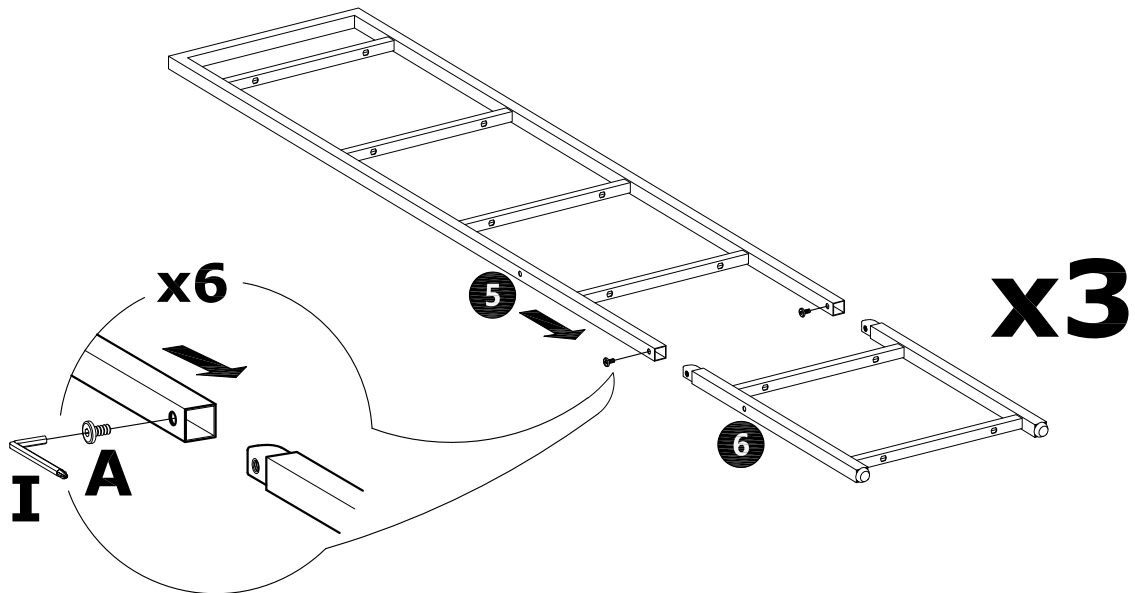

A x 6PCS

Step 2

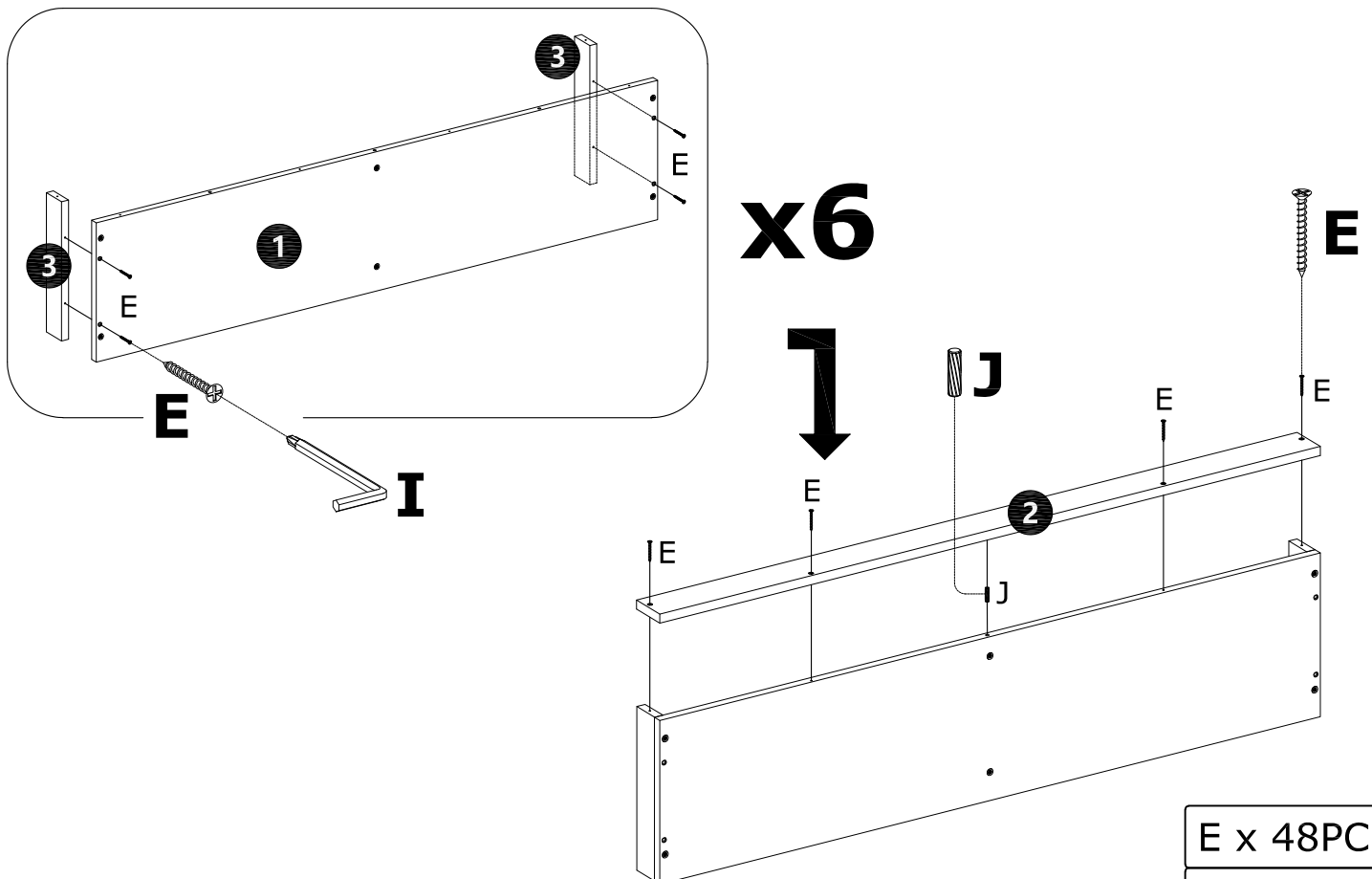

E x 48PCS

J x 6PCS

Step 3

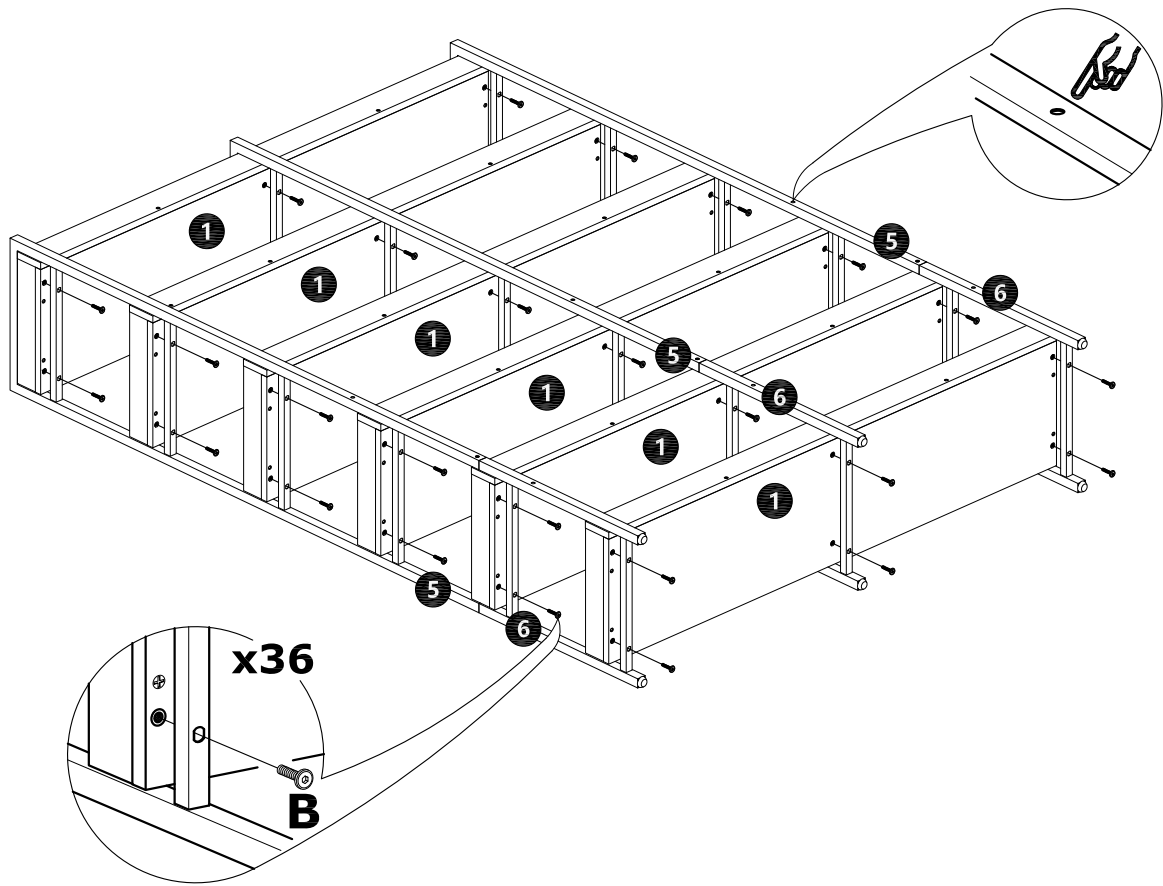

B x 36PCS

Step 4

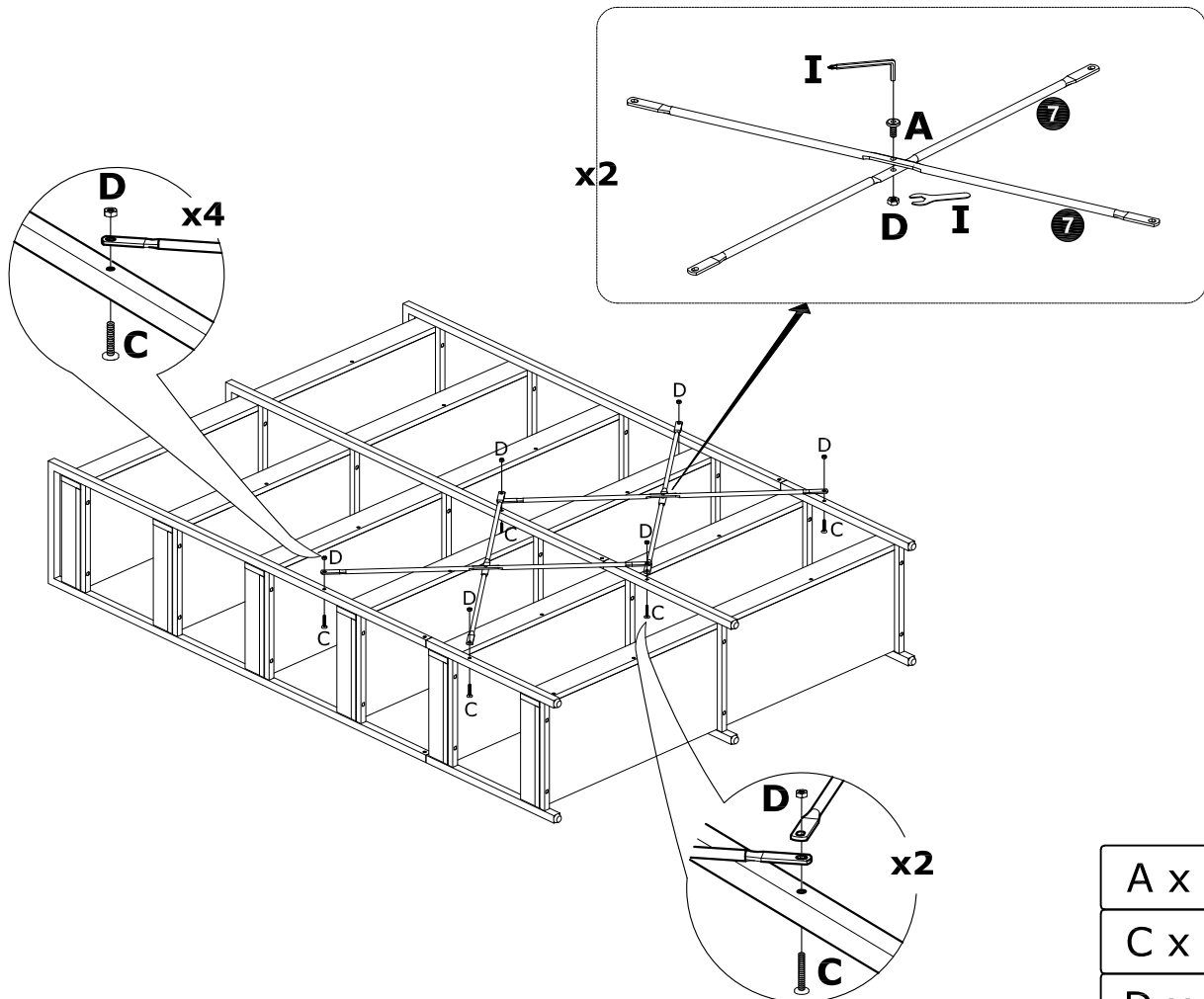

A x 2PCS
C x 6PCS
D x 8PCS

Step 5

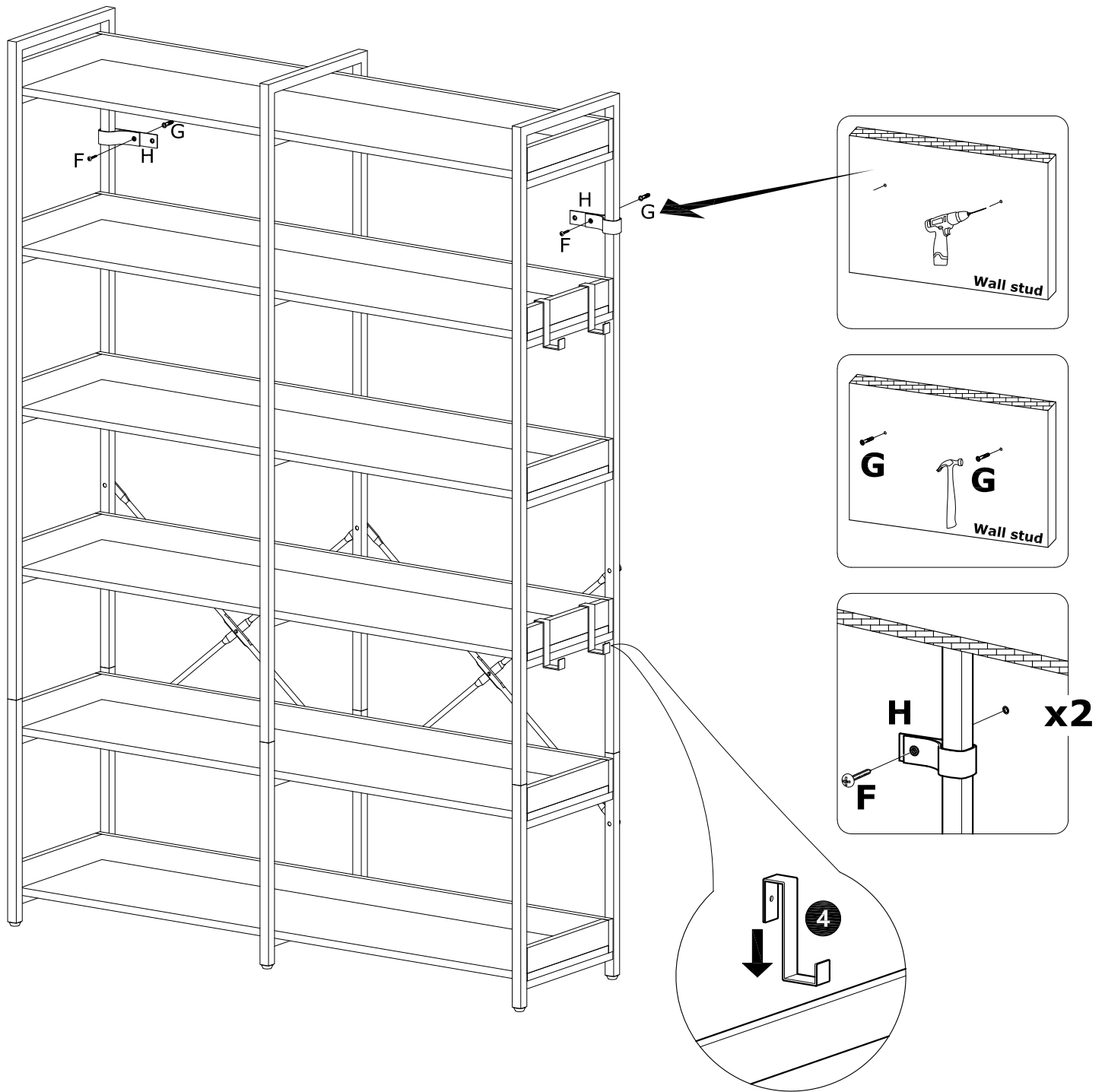

F x 2PCS

G x 2PCS

H x 2PCS