

316-RGS-150-90 – 150 x 90mm

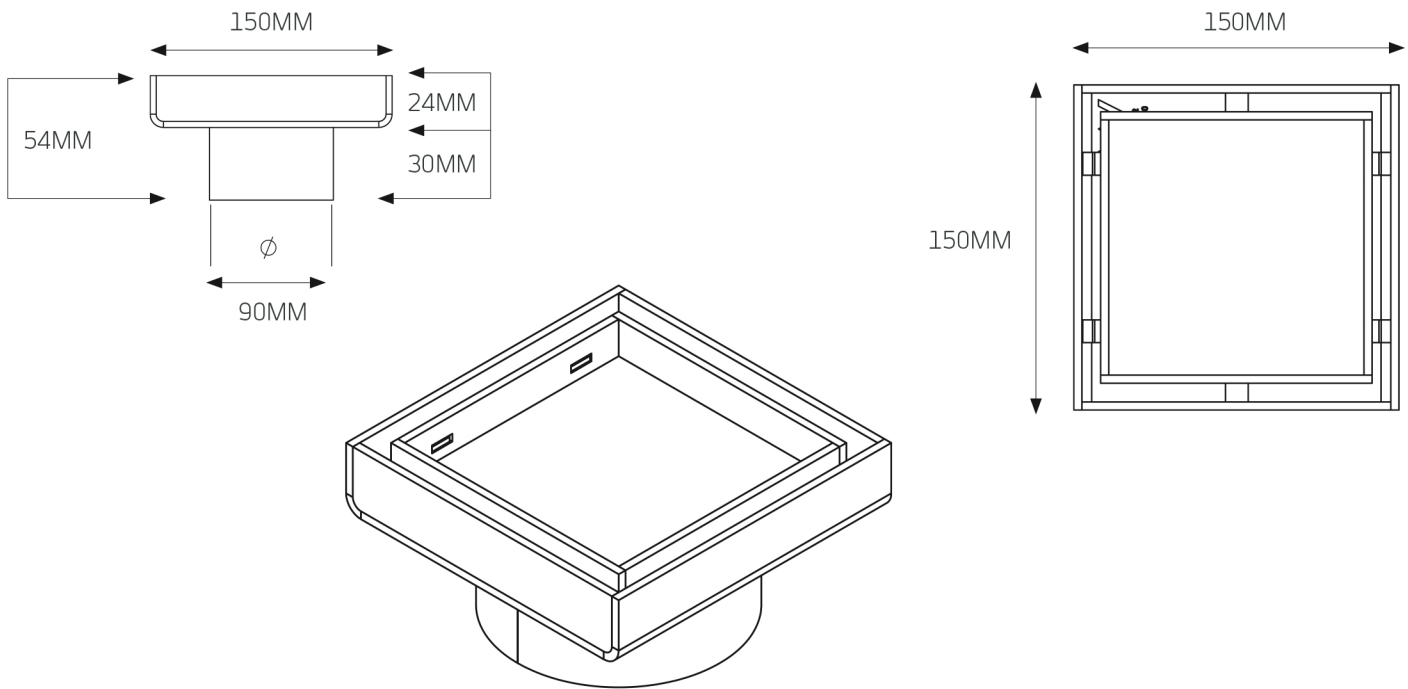

FEATURES	CODE	SIZE (MM)	COLOURS
<ul style="list-style-type: none"> • 316 Marine Grade Stainless Steel • Width: 150 mm • Height: 150 mm • Rolled edges to all exposed edges • 12 mm deep insert can accommodate up to 10 mm tile + adhesive • Covered by a 7 year warranty * 	316-RGS-150-90	150x150x90	Stainless Steel

* The replacement warranty for the coated grates are only applicable until the date of installation. Once Installed any damage to the coatings due to the incorrect use of cleaning products, mis-use or accidental damage, will not be covered under warranty.