

SPECIFICATIONS

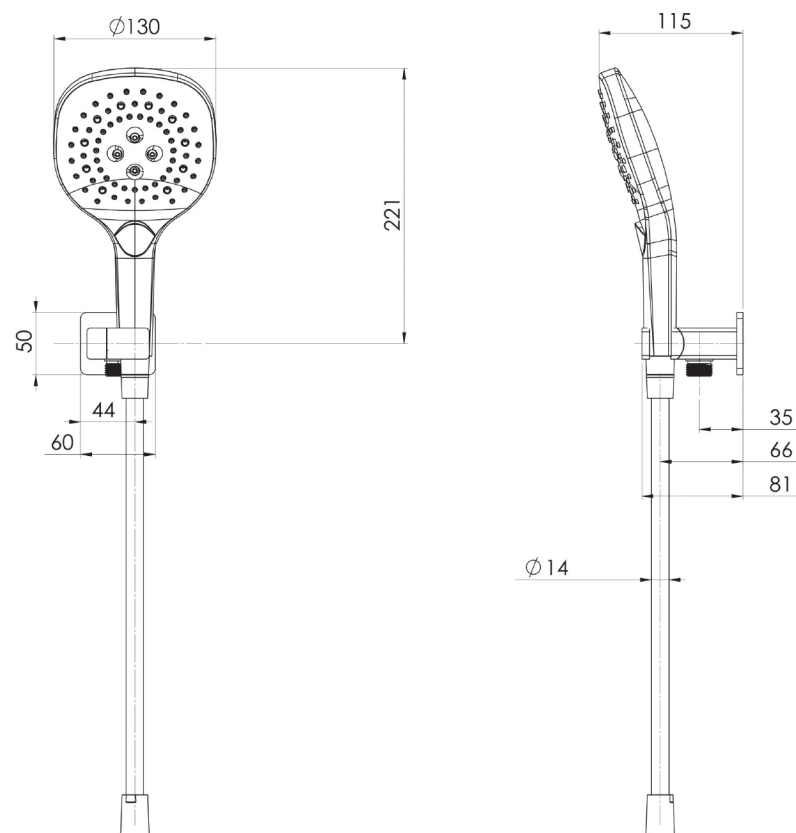

AVAILABLE IN



129-6630-00
Chrome



129-6630-40
Brushed Nickel



129-6630-31
Brushed Carbon



129-6630-80
Matte White

INFORMATION

Temperature Rating
1 - 75°C

Pressure Rating
150 - 500kPa

MAINTENANCE AND CARE:

- All surfaces should be cleaned with mild liquid detergent or soap and water.
- Do not use cream cleaners or citrus based cleaning products, as they are abrasive.
- Use of unsuitable cleaning agents may damage the surface.
- Any damage caused in this way will not be covered by warranty.