

## SPECIFICATIONS

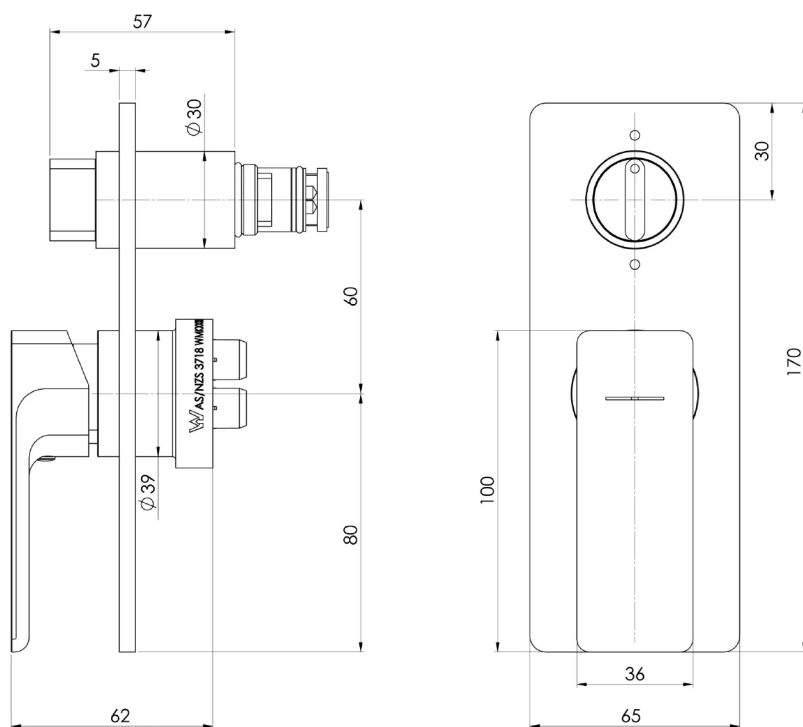

### AVAILABLE IN



135-2940-00  
Chrome



135-2940-40  
Brushed Nickel



135-2940-31  
Brushed Carbon



135-2940-10  
Matte Black



135-2940-12  
Brushed Gold

### INFORMATION

Temperature Rating  
1 - 75°C

Pressure Rating  
150 - 500kPa

### MAINTENANCE AND CARE:

- All surfaces should be cleaned with mild liquid detergent or soap and water.
- Do not use cream cleaners or citrus based cleaning products, as they are abrasive.
- Use of unsuitable cleaning agents may damage the surface.
- Any damage caused in this way will not be covered by warranty.