

## ADJUSTMENT RANGE

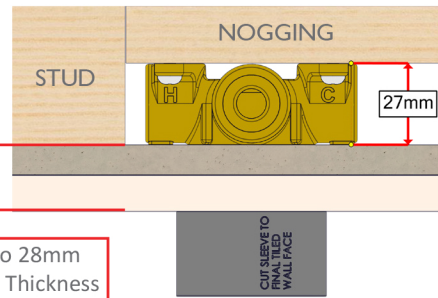

17mm to 28mm  
Total Wall Thickness

Range from the Nogging face to the Stud Face is 27mm as shown.

Adjustment range from the finished face of the tiles to the stud is 17mm to 28mm as shown.

Check Wall Mixer Lugs are Flush to Stud to allow for installation of sheet and tiles

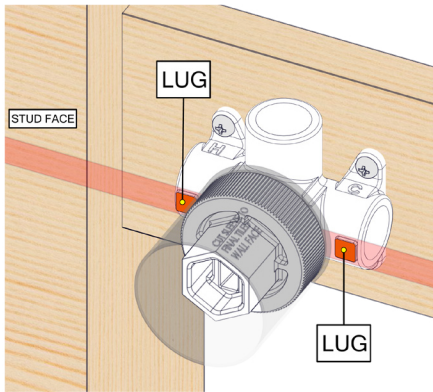

Check Lugs (Highlighted in ORANGE) are Flush with Front of Stud.

- 1 Screw the Mixer Breach onto Nogging to dimensions shown in adjustment range.

Ensure that the mixer body is level.

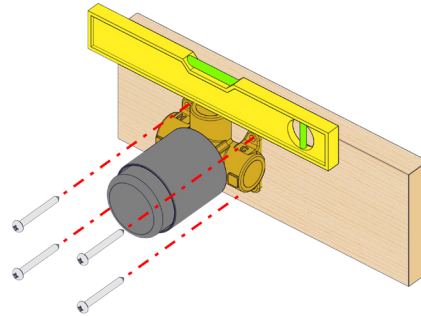

- 2 Plumb all connections to Mixer Body.  
Perform **PRESSURE TEST** and check for leaks.

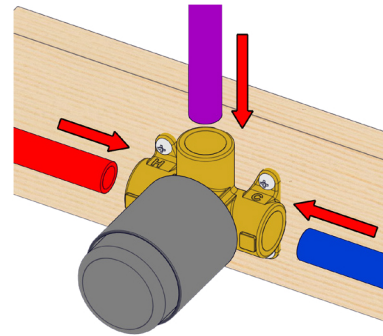

- 3 Create a 50mm diameter hole in the cement sheet or Plasterboard.

Apply waterproofing membrane up to Waterproofing Sleeve.

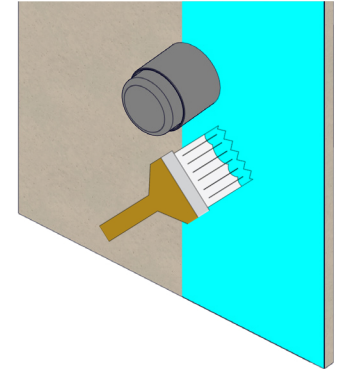

- 4 After Tiling use Knife to Trim Waterproofing Sleeve flush to Tile face.

Remove Protective Cover.

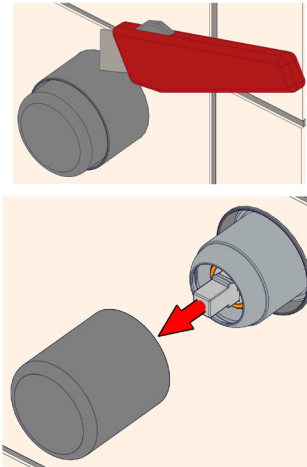

- 5 Gently Push Dress plate over assembly.  
Push Handle onto Cartridge.

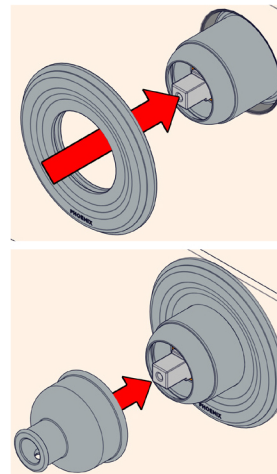

- 6 Tighten Screw into Cartridge securing Handle.

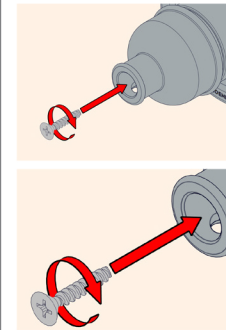

- 7 Push Handle Cap into position. Ensuring correct orientation.

Tighten Pin into position.

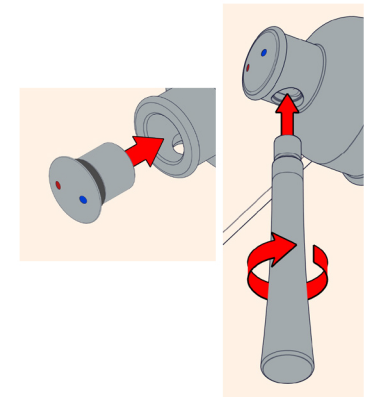

recommended working pressure

**150-500KPa**

maximum hot water temperature

**75 degrees**