

108

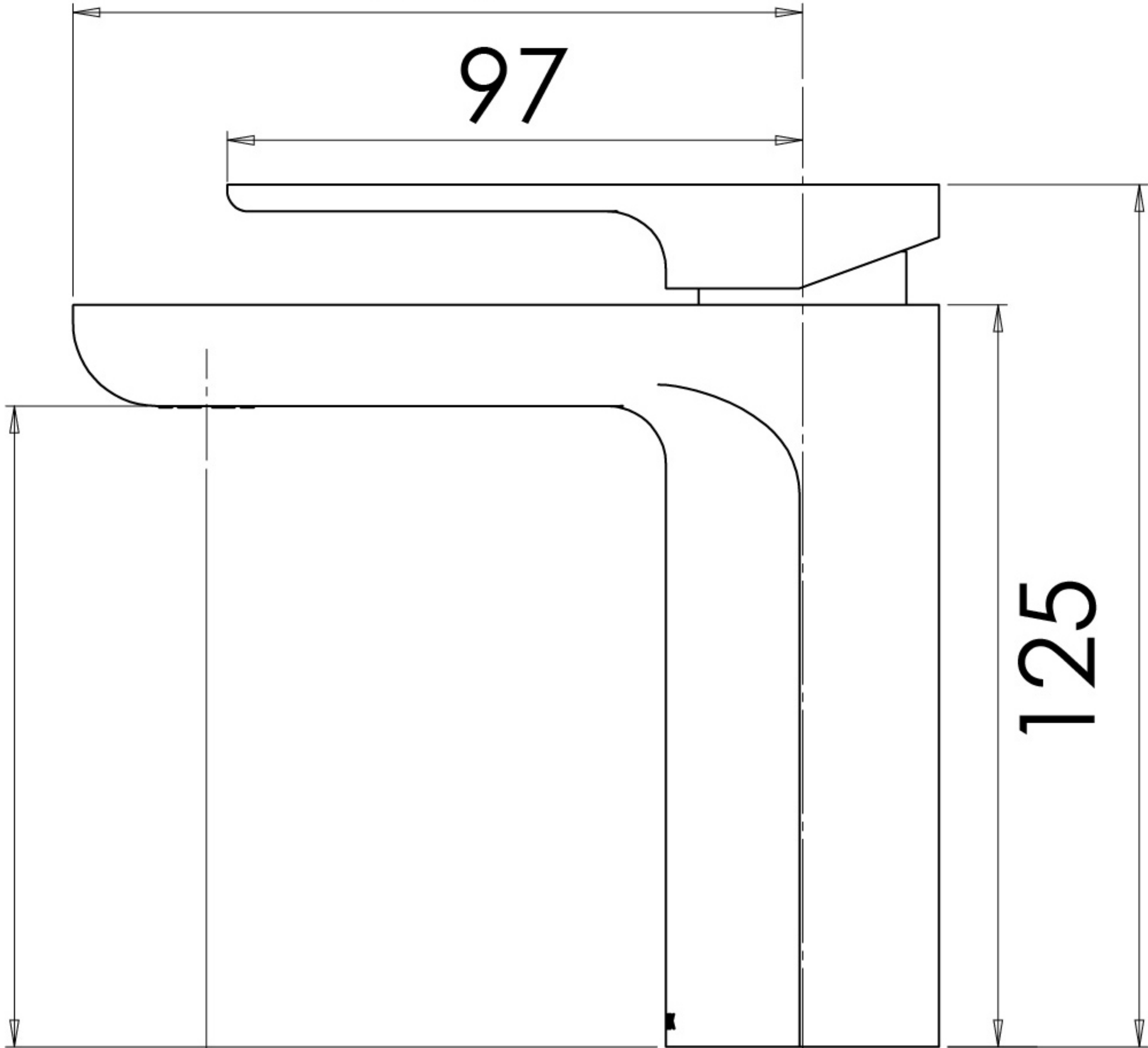

123

97

145

125

101

46