

OFFICE CHAIR

Hardware



M6*16mm

A

4x



B

4x



C

1x

Components

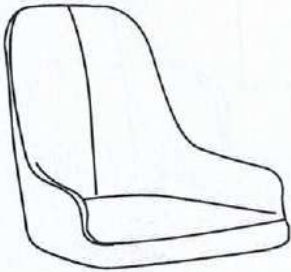

D

1x



E

1x



F

1x

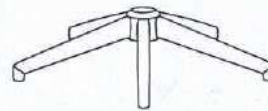

G

1x



H

5x

Step 1

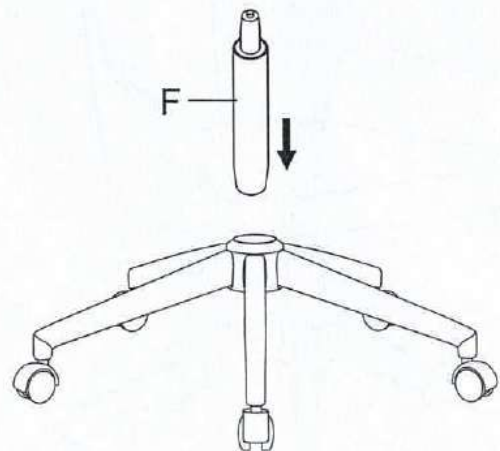
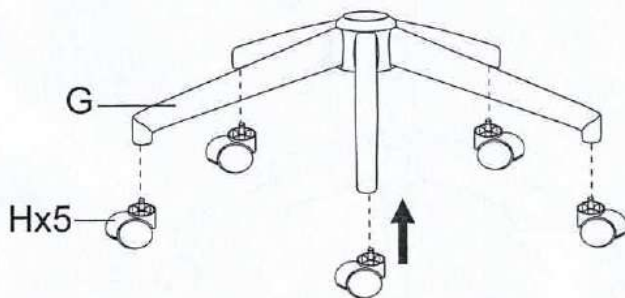
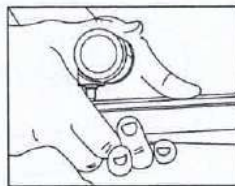

TIK OFFICE CHAIR

Step 2

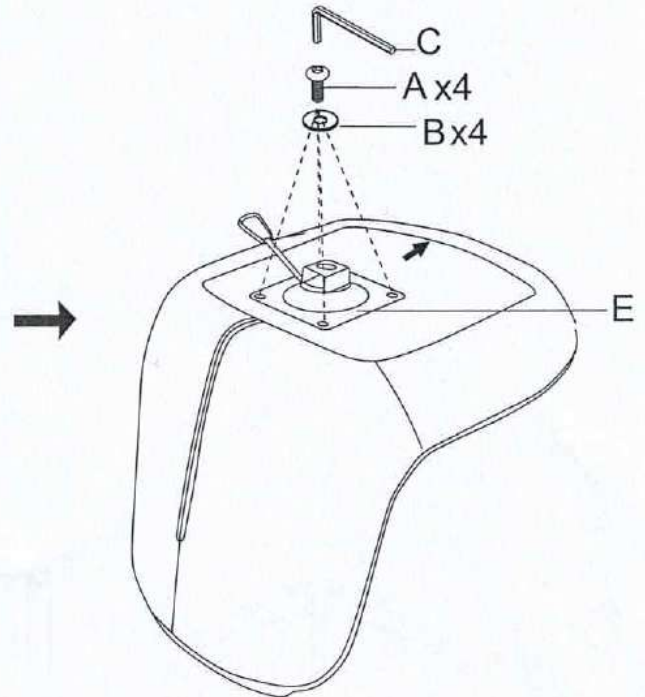
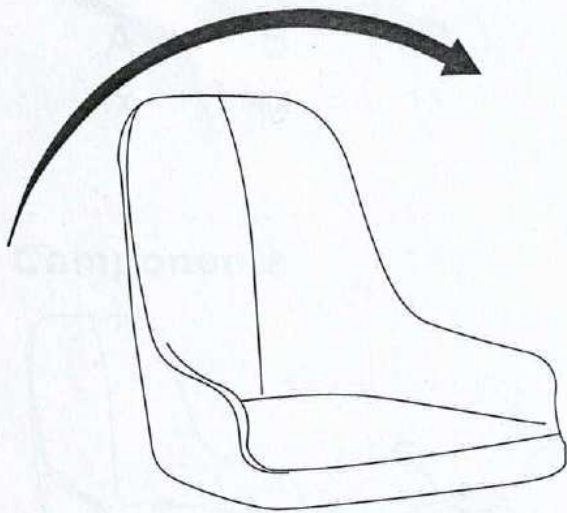

Step 3

