

ASSEMBLY INSTRUCTION

MODEL : LUCT-BM3008-1 (Christine Queen Bed)







Before you begin, please follow Assembly Instruction carefully. Then follow them step by step.



PART LIST

NO	DESCRIPTION	QTY
1	Head Board	1pc
2	Foot Board	1pc
3	Wood Post	4pcs
4	Side Rail L/R	2pcs
5	Support Bar (Front)	2pcs
6	Support Bar	2pcs
7	Support Bar (Center)	1pc
8	Veneer Slats	20pcs
9	Support Leg (Long)	2pcs
10	Support Leg (Short)	2pcs

HARDWARE LIST

NO	DESCRIPTION	QTY
A	JCBC M6 x 30mm 	16pcs
B	JCBC M6 x 45mm 	6pcs
C	JCBC M6 x 50mm 	4pcs
D	M6 Hex Nut 	6pcs
E	Allen Key M4 	1pc
F	 Small Bed Holder (PVC)	20pcs
G	 Big Bed Holder (PVC)	10pcs

STEP 1

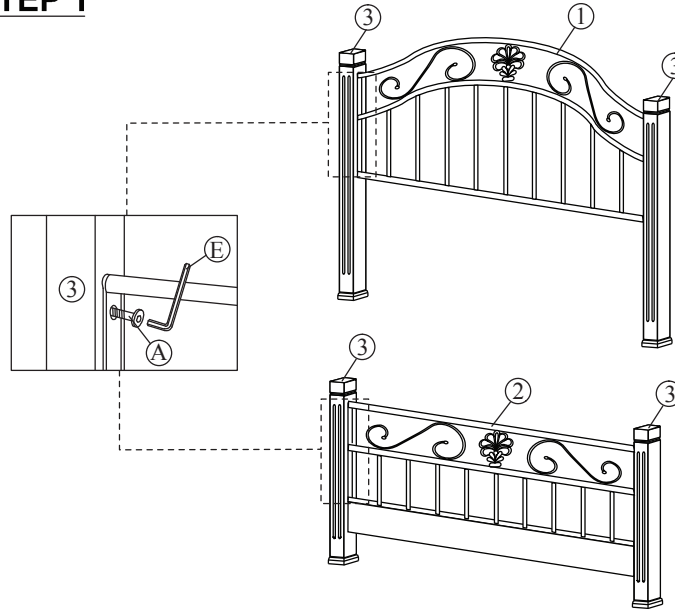

STEP 2

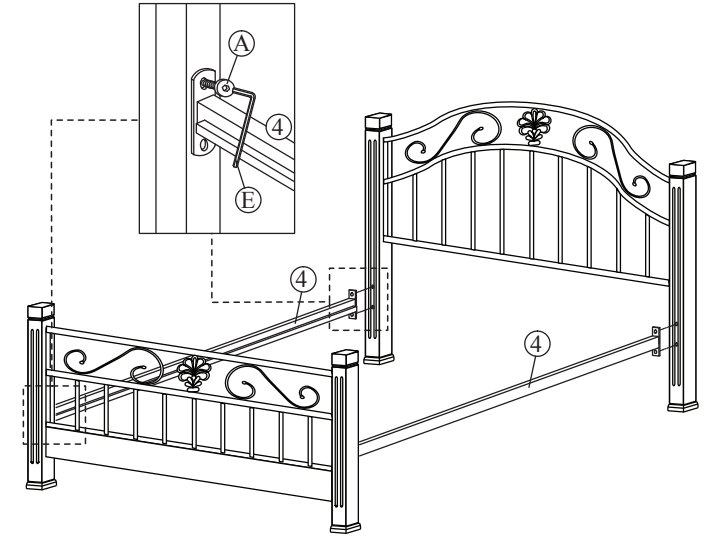

STEP 3

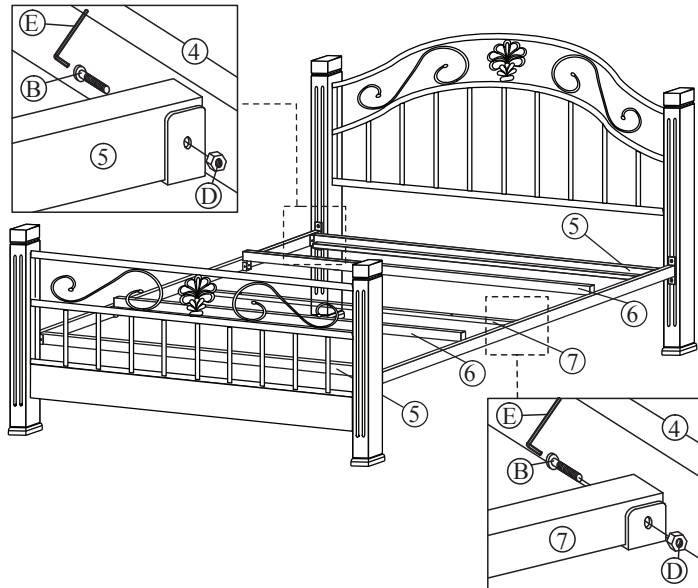

STEP 4

