

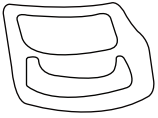

INSTALLATION STEP DIAGRAM

PARTES

a BACK



b SEAT

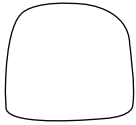

c MECHANISM

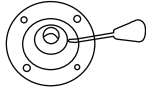

j BASE

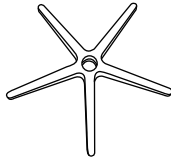

l GAS LIFT

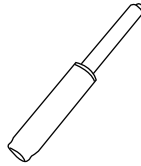

h WRENCH



g CASTER



5pcs

o  10pcs

t  4pcs

m HEADREST

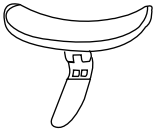

p



n ARMREST



2pcs

1

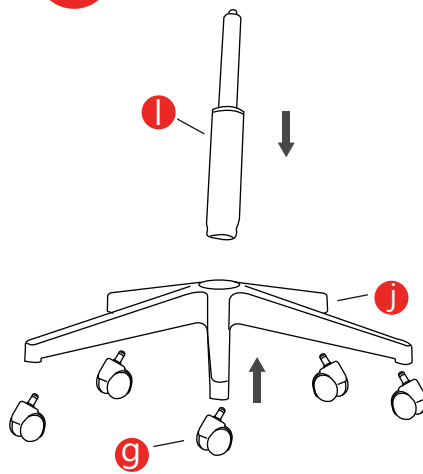

2

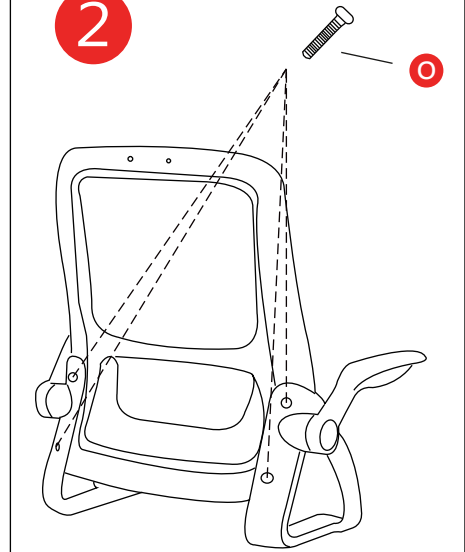

3

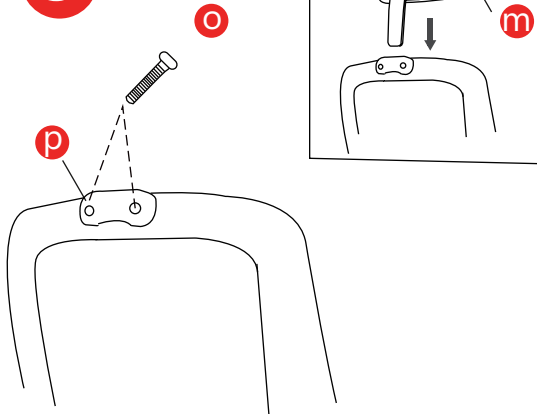

4

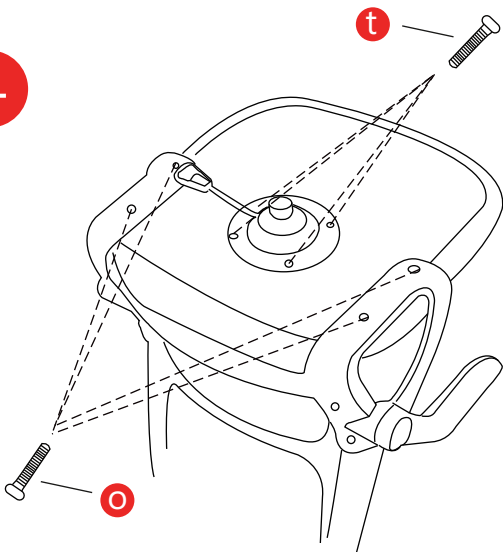

5

