

ASSEMBLY INSTRUCTIONS

Please read the instructions carefully before assembly and keep it for future reference.

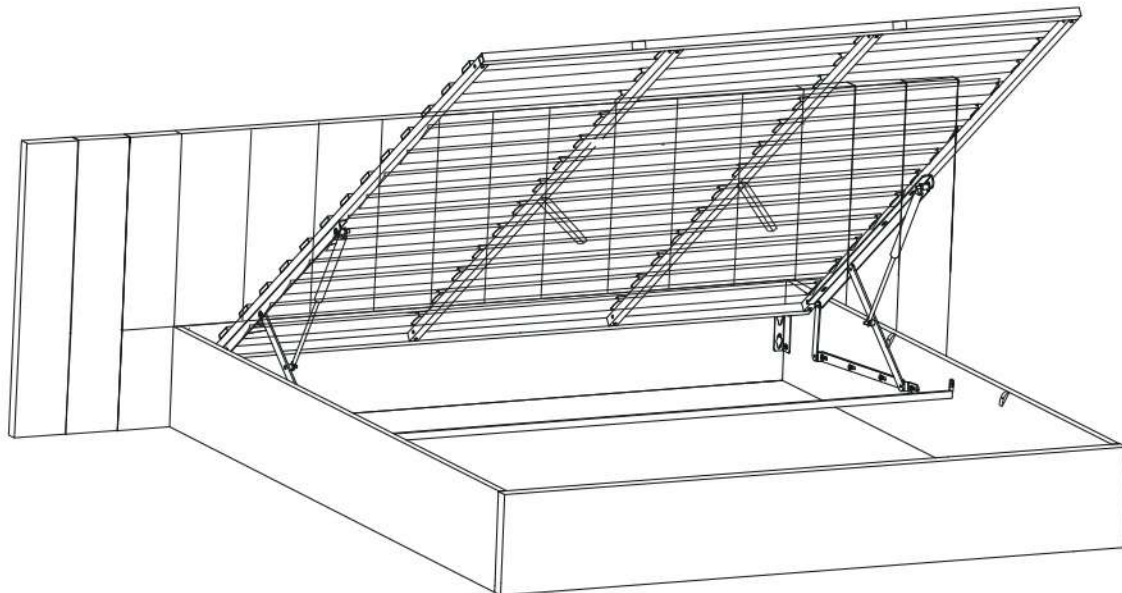
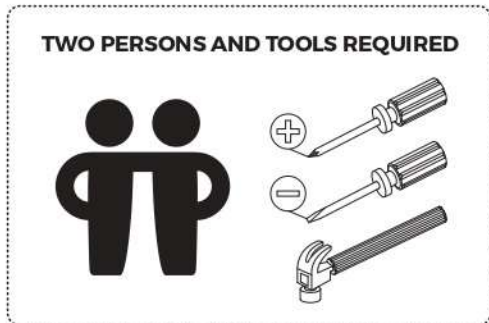

BED FRAME

Model : BF-B-EMPO-K

Version 1.0

Safety Instructions for Use

1. Operational Clearance:

Before raising or lowering the gas-lift bed, ensure the areas on, under, and around the frame are entirely clear of people (especially children) and pets. Additionally, remove all fragile items or liquids from the bed surface before operation to prevent spills or damage.

2. Full Extension:

When lifting the bed frame, firmly grasp the pull strap and lift to its maximum height. Ensure the gas-lifts are fully engaged and the frame is securely locked in the open position before releasing your grip.

3. Safe Storage Access:

Always verify that the bed frame is stable and fully supported before reaching into or placing items within the under-bed storage compartment. Never rely on partial elevation for access.

4. Strut Maintenance:

If the gas-lifts show signs of weakened tension or fail to support the frame's weight adequately, discontinue use of the lift mechanism immediately and contact the seller for genuine replacement parts.

5. Weight Capacity:

For your personal safety and to extend the product's lifespan, ensure the combined weight of the mattress and bedding does not exceed the maximum load capacity of the gas-lifts.

Max Loaded Suggestion(KG)

Size (Gas lift bed)	Gas lift spec (N)	Including Mattress and Bedding (KG)	Size (Gas lift bed)	Gas lift spec (N)	Including Mattress and Bedding (KG)
Single	600	50	Queen	700	60
King Single	600	50	King	800	70
Double	600	50			

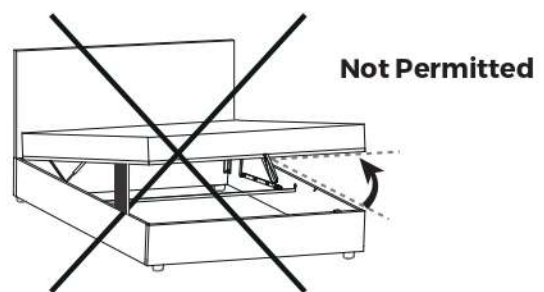
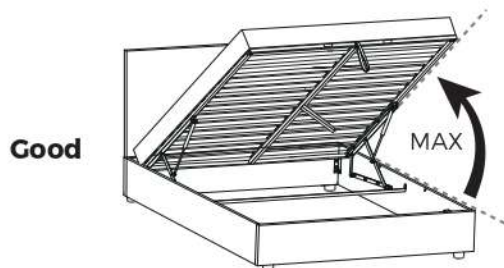

Do not use external objects to prop up the bed frame if the gas-lifts are not fully extended.

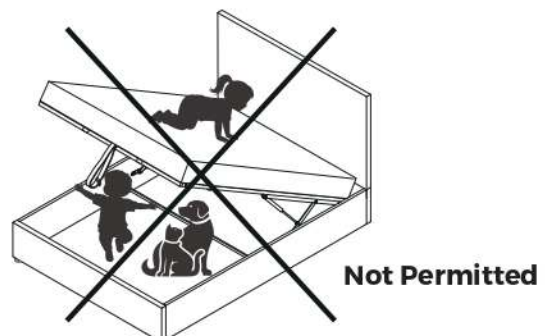
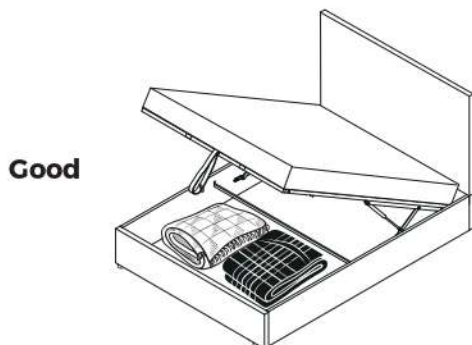

Under-bed space is for storage only. Ensure children and pets keep clear of the storage area and do not remain on the bed while it is lifted.

Assembly and Maintenance Tips



1. Keep children and pets away from the working area as small parts may cause choking if swallowed.



2. Some furniture may require two persons to assemble for safety reasons.

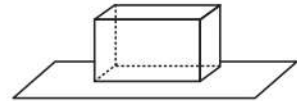

3. To protect the surfaces of the furniture, lay the parts and perform the assembly on top of a soft mat (such as a carpet or cardboard).



4. Keep the furniture away from direct sunlight to avoid fading.



5. Use a soft, damp cloth to clean or wipe surfaces.



6. Never use ammonia-based or abrasive cleaning products to clean as they may damage the finish.



7. Do not place liquids or wet items on furniture as they may leave water marks/stains. Always use a coaster or runner to protect the furniture surface.



8. When moving the bed frame, please lift it up with two persons to help move it. Do not drag, push or pull the bed frame as these actions may damage the bed frame legs.

Assembly Checklist

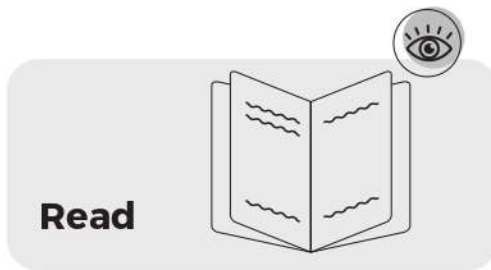

Read

Read through the instructions carefully before you begin.

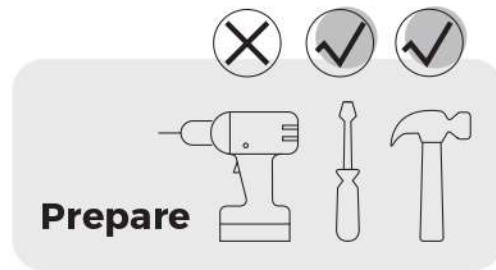

Prepare

Make sure you have all the required tools. Never use power tools unless instructed.

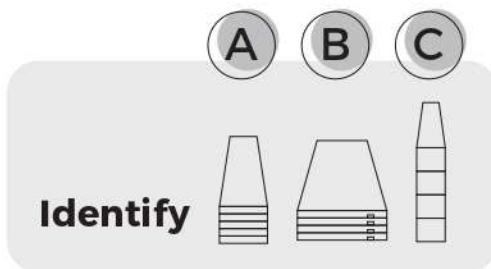

Identify

Identify and lay out all of the components before you begin assembly.

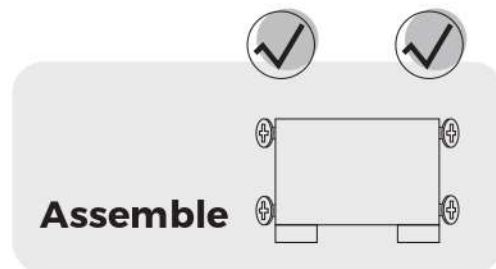

Assemble















Please fully tighten all screws during the assembly process unless instructed not to do so.

Helpful Information

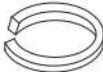
- ! Never use power tools unless specifically instructed. They can damage your components or hardware if used incorrectly.
 - ! The most common mistakes made during assembly are using the wrong hardware or getting components back to front.
 - ! When assembling the product, it is recommended to do so on top of a soft surface such as a carpet or cardboard to avoid scratches and damages to the furniture surfaces.
 - ! Bulky items such as wardrobes should be assembled in the location when the assembled piece will be used to avoid moving them through doors or tight passages.
 - ! Never use any glue until you are certain that the parts belong together.
 - ! Periodically check that all connections are secured and follow all care and maintenance instructions stated.
 - ! If you encounter any assembly difficulties or missing components and/or hardware, please contact our Customer Service for further assistance.
-

Hardware List

Please ensure that all parts and hardware are in the packaging contents. If there are any missing parts and/or hardware, please contact our Customer Service as soon as possible.





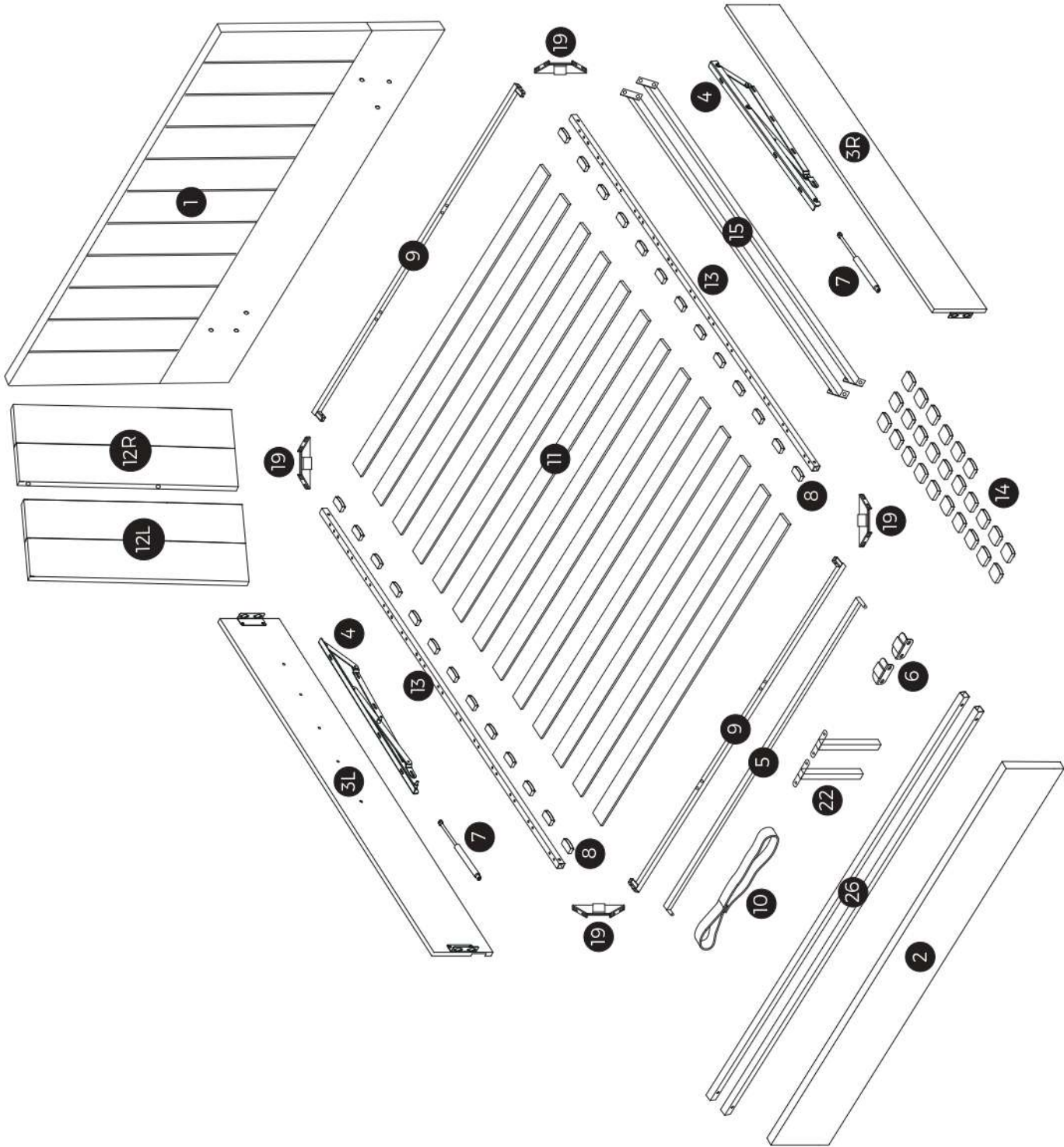





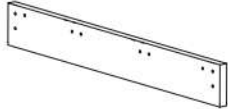
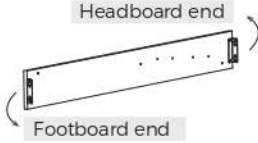
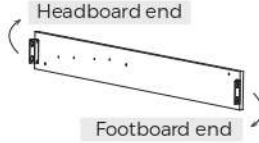

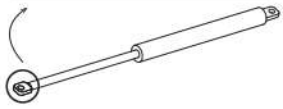

<p>Part A 22pcs M8x40mm Bolt</p> 	<p>Part B 12pcs M8x30mm Bolt</p> 	<p>Part C 4pcs M8x16mm Bolt</p> 	<p>Part D 8pcs Plastic Washer</p> 
<p>Part E 10pcs M6x16mm Bolt</p> 	<p>Part F 22pcs M8 Nuts</p> 	<p>Part G 1pc Spanner</p> 	<p>Part H 1pc M5 Allen Key</p> 
<p>Part L 12pcs Flat Washer</p> 	<p>Part M 8pcs Spring Washer</p> 	<p>Part N 4pcs M8x50mm Bolt</p> 	<p>Part O 4pcs Plastic Spacer</p> 
<p>Part Q 8pcs M3x16mm Screw</p> 	<p>Part W 1pc M4 Allen Key</p> 	<p>Part Y 4pcs M8x65mm Bolt</p> 	

Parts

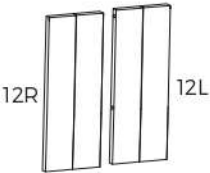

Parts List

Please ensure that all parts and hardware are in the packaging contents. If there are any missing parts and/or hardware, please contact our Customer Service as soon as possible.

<p>Part 1 1pc Headboard</p> 	<p>Part 2 1pc Footboard</p> 	<p>Part 3L 1pc Side Rail Left</p> 	<p>Part 3R 1pc Side Rail Right</p> 
<p>Part 4 2pcs Hinge</p> 	<p>Part 5 1pc Cross Beam</p> 	<p>Part 6 2pcs Angle Bracket</p> 	<p>Part 7 2pcs Gas Strut</p> <p>The bronze hook can be rotated to install the screw.</p> 
<p>Part 8 26pcs Plastic Slat Cap</p> 	<p>Part 9 2pcs Front And Rear Frameworks</p> 	<p>Part 10 1pc Rope</p> 	<p>Part 11 13pcs Slat</p> 
<p>Part 12 1 set Wing</p> 	<p>Part 13 2pcs Side Beam</p> 	<p>Part 14 26pcs Centre Slat Cap</p> 	<p>Part 15 2pcs Long Beam</p> 
<p>Part 19 4pcs Metal Corner Bracket</p> 	<p>Part 22 2pcs Centre Support Leg</p> 	<p>Part 26 2pcs Connect Beam</p> 	

STEP 1

Part B

4pcs
M8x30mm



Part H

1pc
M5

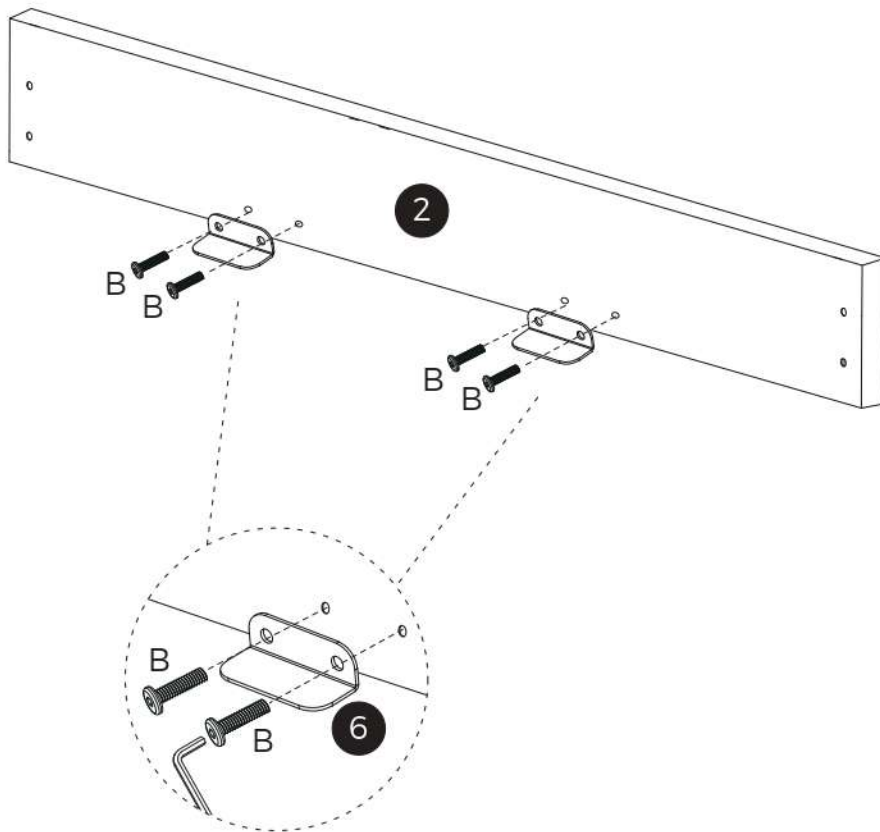

Attach 6 to 2 with bolts (B).

STEP 2

Part A

8pcs
M8x40mm



Part D

8pcs



Part H

1pc
M5



Part L

8pcs

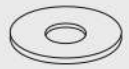

Part M

8pcs

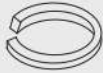

Part O

4pcs



Part Q

8pcs
M3x16mm

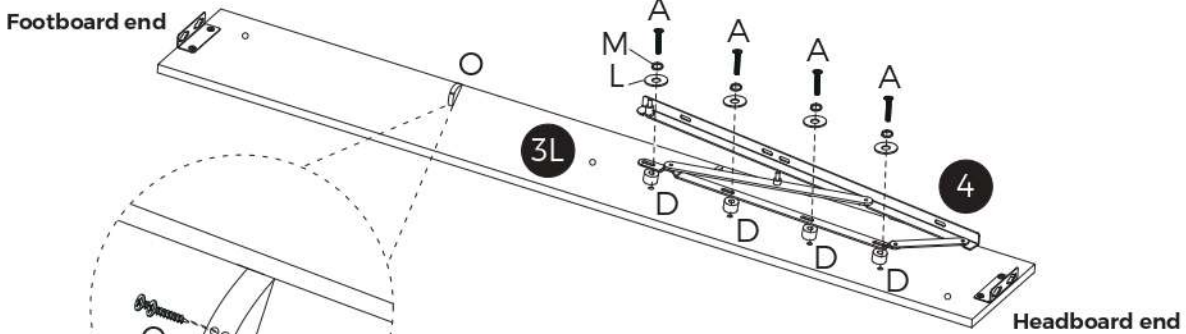

Attach the plastic spacer (O) to the marked area on the side rail. Make sure the edge of the plastic spacer (O) is align with the edge of the side rail (3R/3L).

x4

Install 4 pieces

Attach the hinge (4) to the headboard end of the side rails (3L and 3R) with M8 bolts (A), plastic washers (D), flat washers (L) and spring washers (M).

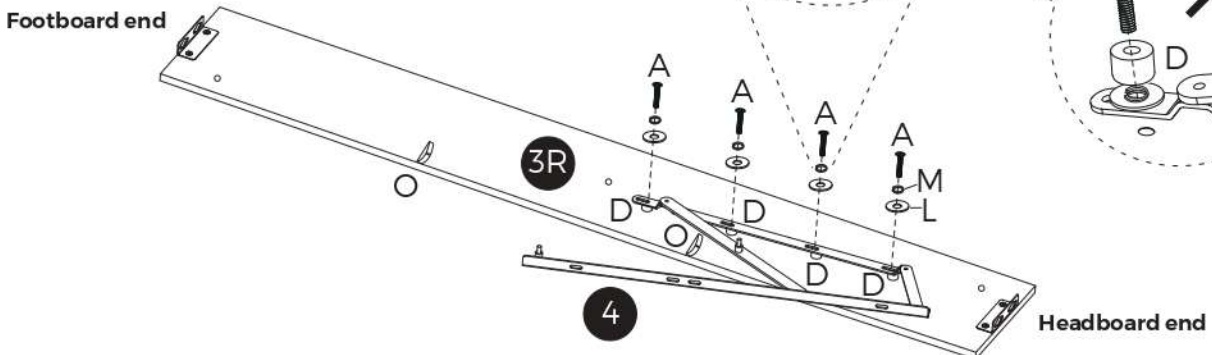

STEP 3

Part B

8pcs
M8x30mm



Part H

1pc
M5



ATTENTION

Ensure that the bed frame is assembled properly with all sides at right angles as shown. The gas lift mechanism will not work if the bed frame is out of shape.

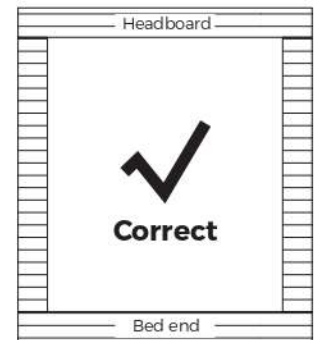
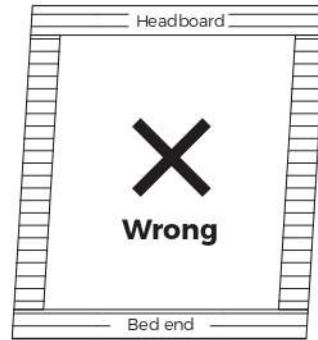

Attach the side rail left (3L) to the headboard (1) and footboard (2) with M8 bolts (B).

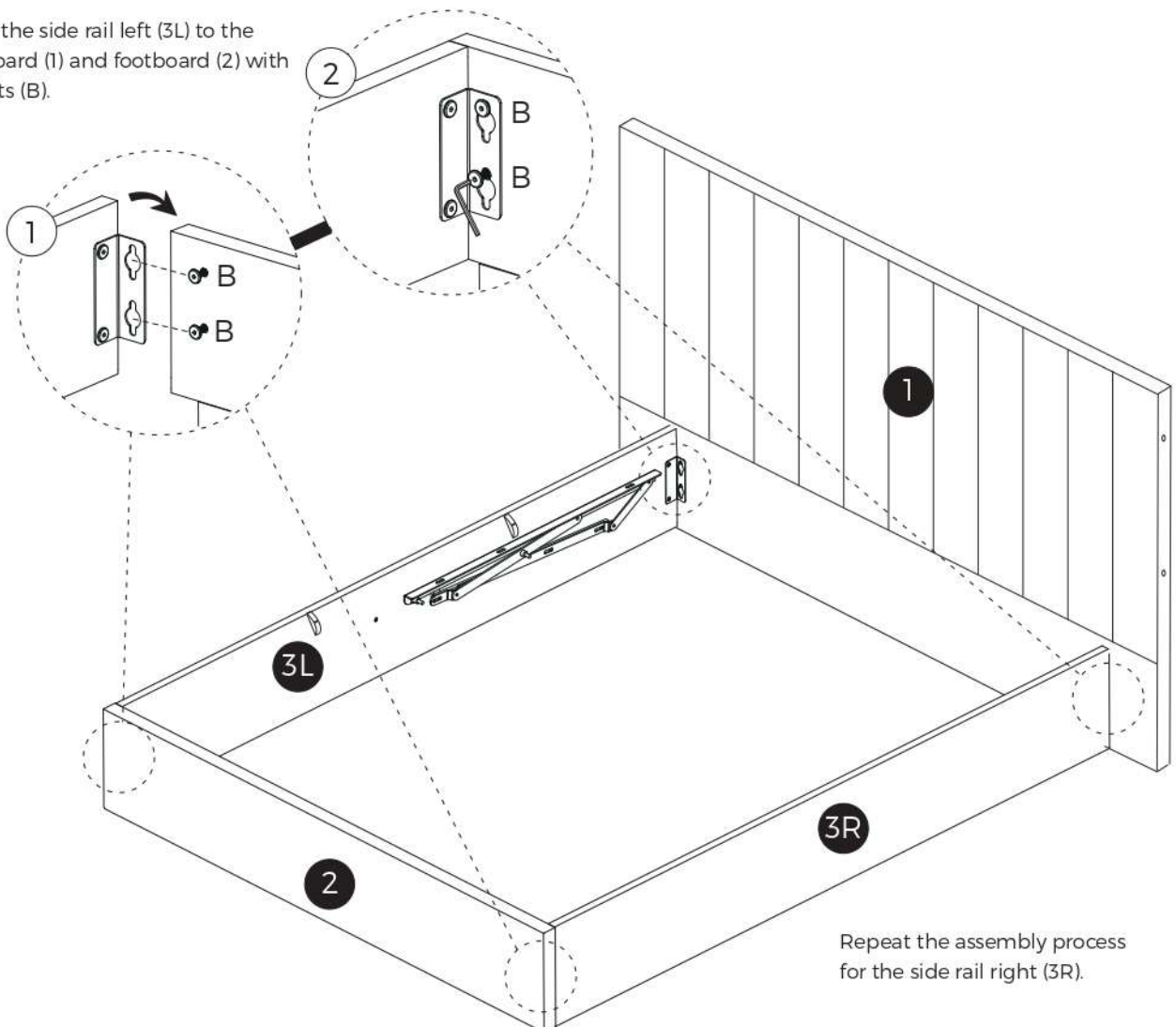

Repeat the assembly process for the side rail right (3R).

STEP 4

Part E

10pcs
M6x16mm



Part W

1pc
M4



Attach the metal corner bracket (19) to both the side rails (3L and 3R) and the footboard (2) with M6 bolts (E). Note the position of the metal corner bracket above the joint.

Attach the metal corner bracket (19) to both the side rails (3L and 3R) and the head board (1) with M6 bolts (E). Note the position of the metal corner bracket below the joint.

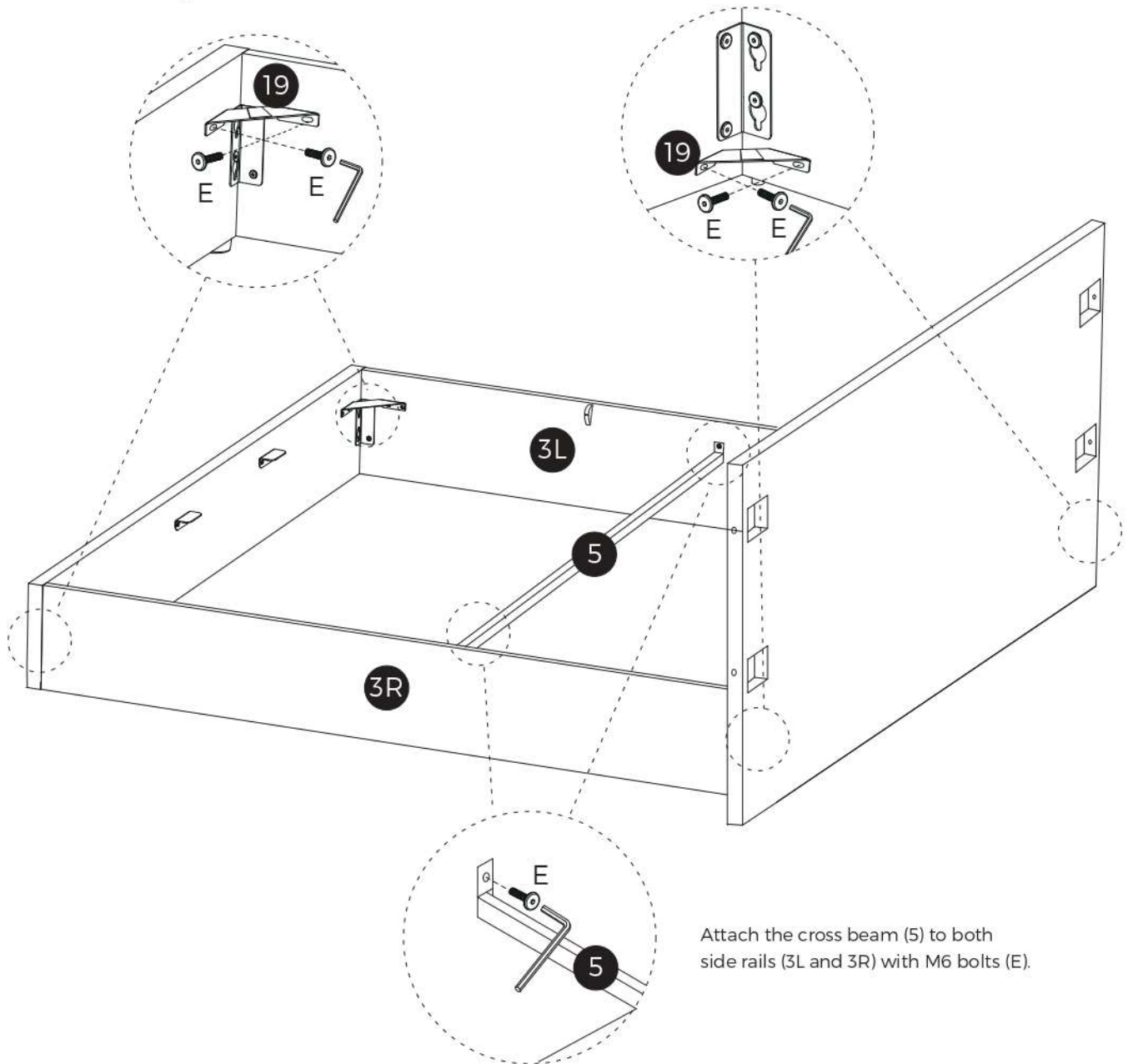

Attach the cross beam (5) to both side rails (3L and 3R) with M6 bolts (E).

STEP 5

Part A

8pcs
M8x40mm



Part C

4pcs
M8x16mm



Part F

8pcs
M8



Part H

1pc
M5



Repeat the assembly process for the side rail right (3R).

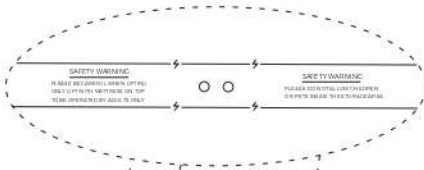

Ensure that the holes on 13 and 15 are aligned as shown.

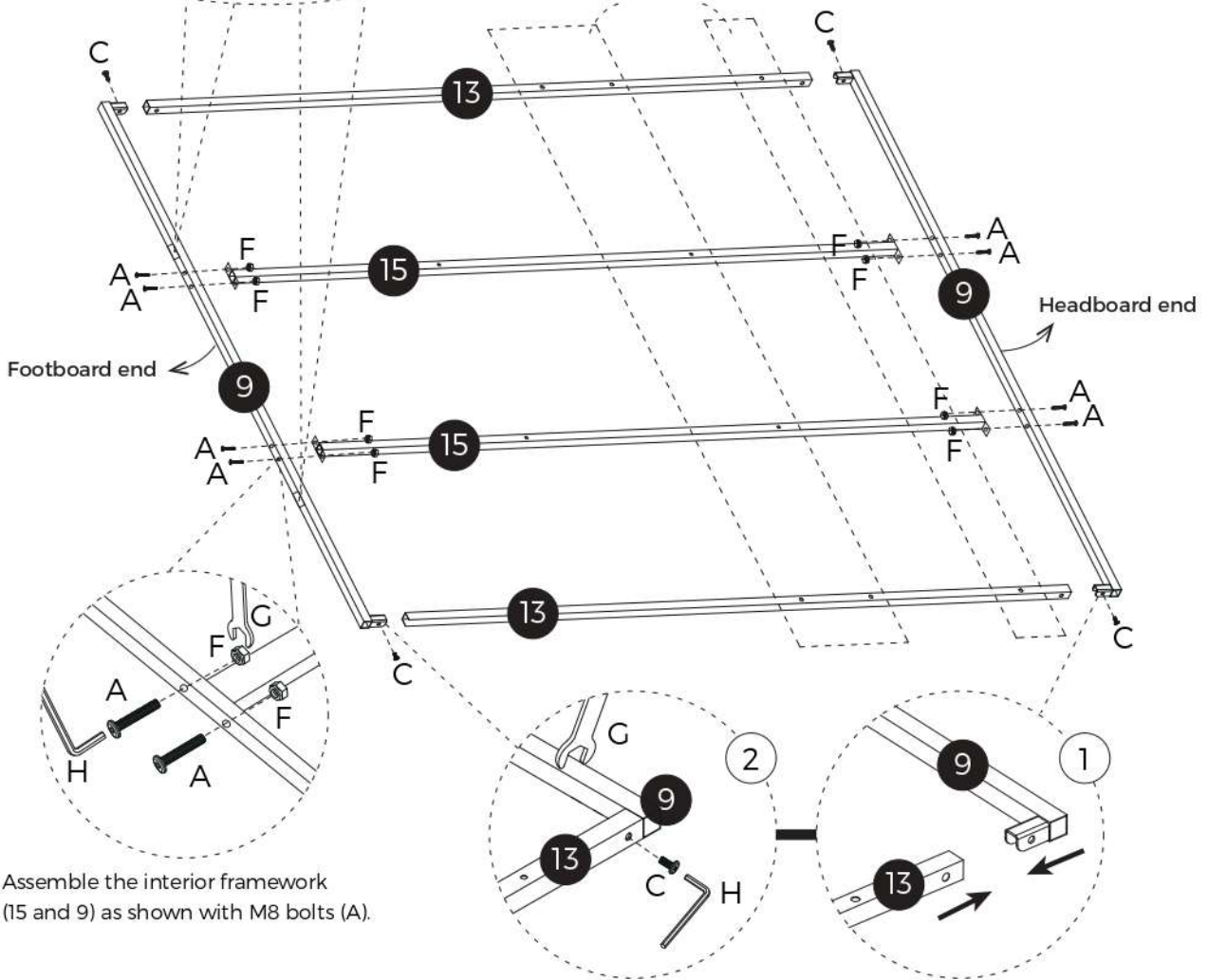

Assemble the interior framework (15 and 9) as shown with M8 bolts (A).

Assemble the interior framework (13 and 9) as shown with M8 bolts (C).

Ensure that the holes are aligned when joining 13 and 9.

STEP 6

Part A

2pcs
M8x40mm



Part F

6pcs
M8



Part H

1pc
M5



Part Y

4pcs
M8x65mm



ATTENTION

Installation sequence:
First, attach 13 to 4 with screws (A) and then attach 26 to 13 with screws (Y).

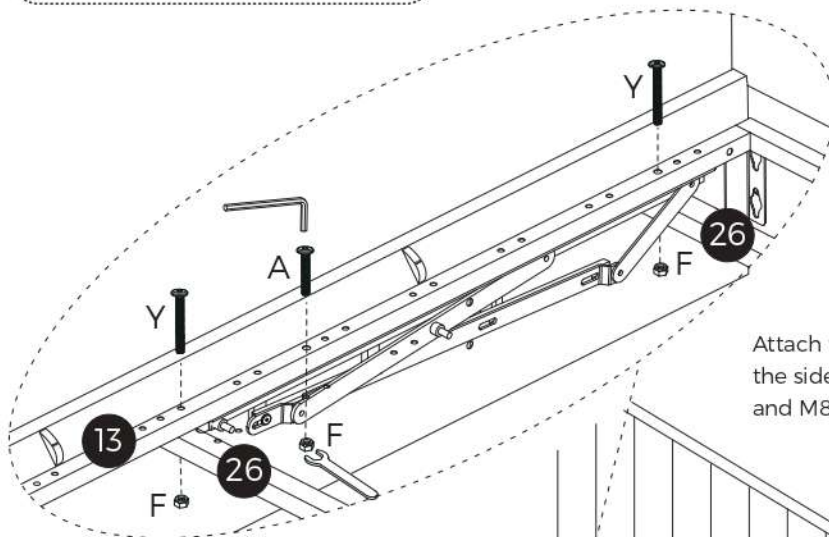
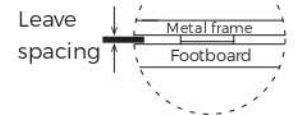
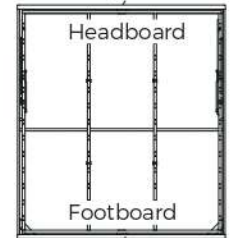
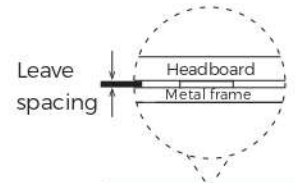
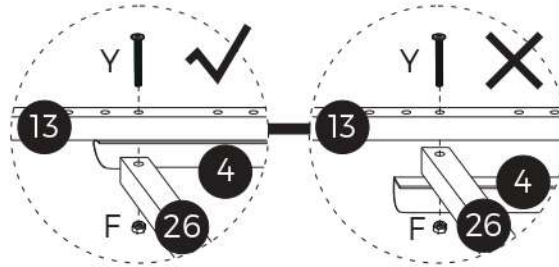

Attach the connect beam (26) to the side beam (13) with M8 bolts (Y) and M8 nuts (F) as shown.

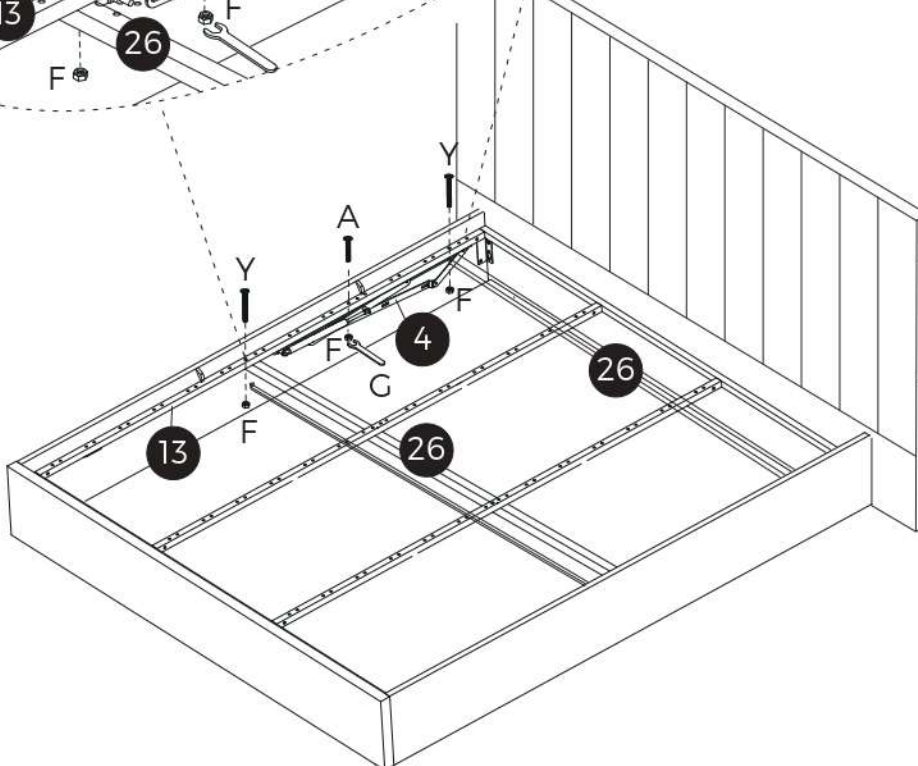

Firstly, attach the hinge (4) to the side beam (13) with M8 bolts (A) and M8 nuts (F).

Do not fully tighten the M8 bolts (A) at this stage to allow for some adjustments between the headboard, footboard and metal framework. There should be some spacing between the headboard, footboard and metal framework.

Once all parts are aligned, fully tighten all M8 bolts (A).

STEP 7

Part A

4pcs
M8x40mm



Part F

4pcs
M8



Part G

1pc



Part H

1pc
M5



ATTENTION

When the centre support legs are installed, they will be about 5mm off the floor. This is normal. When weight is placed on the bed frame, the support legs will come into contact with the ground.

Attach the centre support legs (22) to the long beams (15) with M8 bolts (A) and M8 nuts (F) as shown.

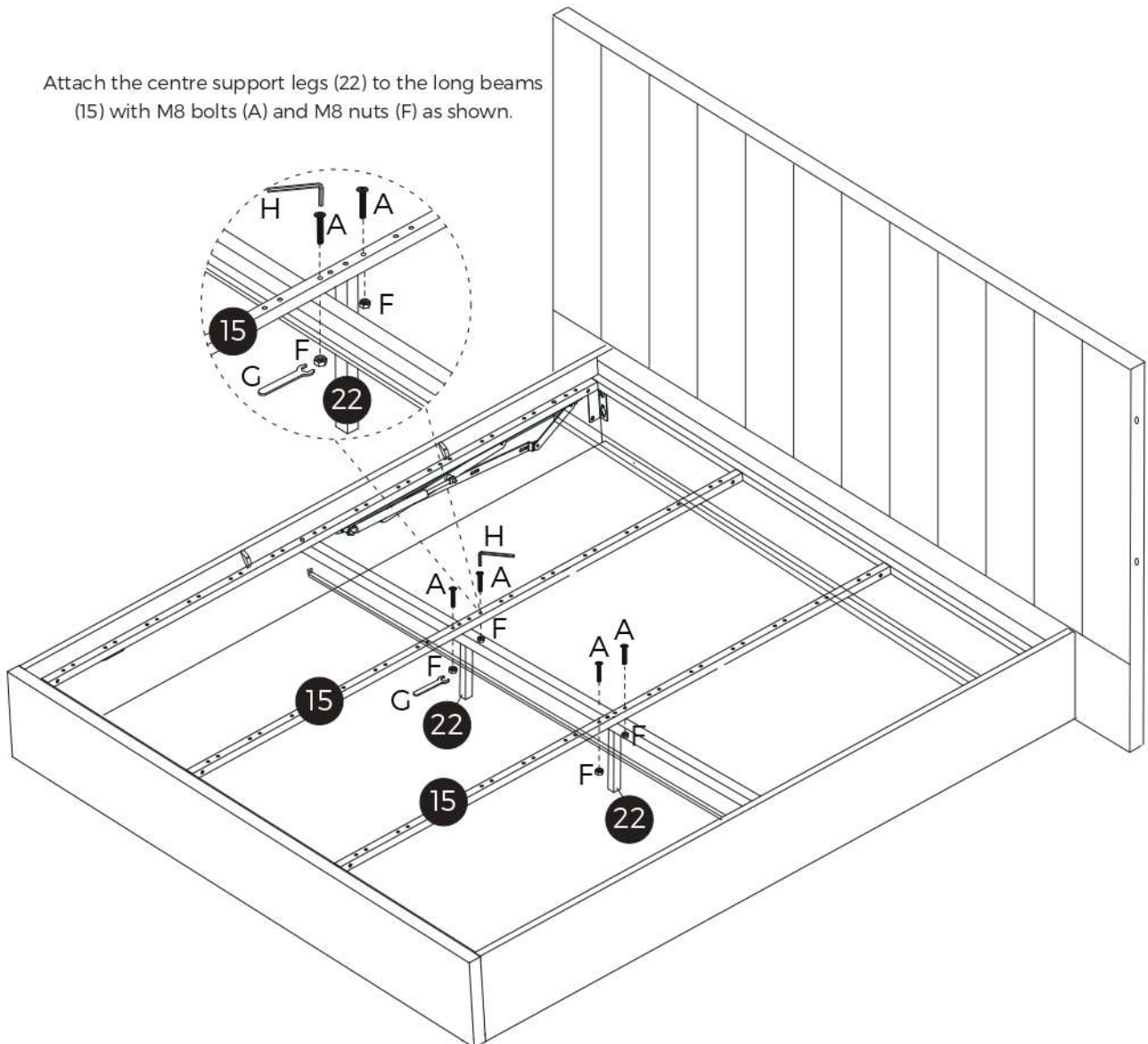

STEP 8

Part 10

1pc

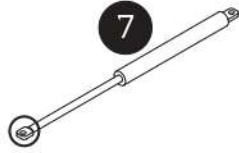

The bronze hook on the gas strut (7) can be rotated to install the screw.

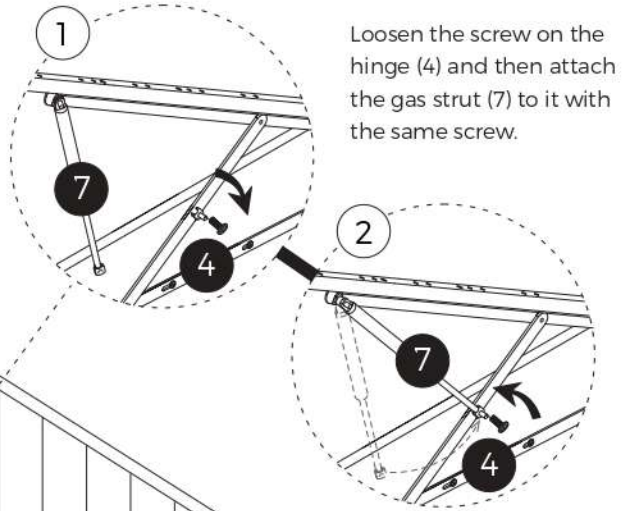

Tie the rope (10) to the metal frame as shown.

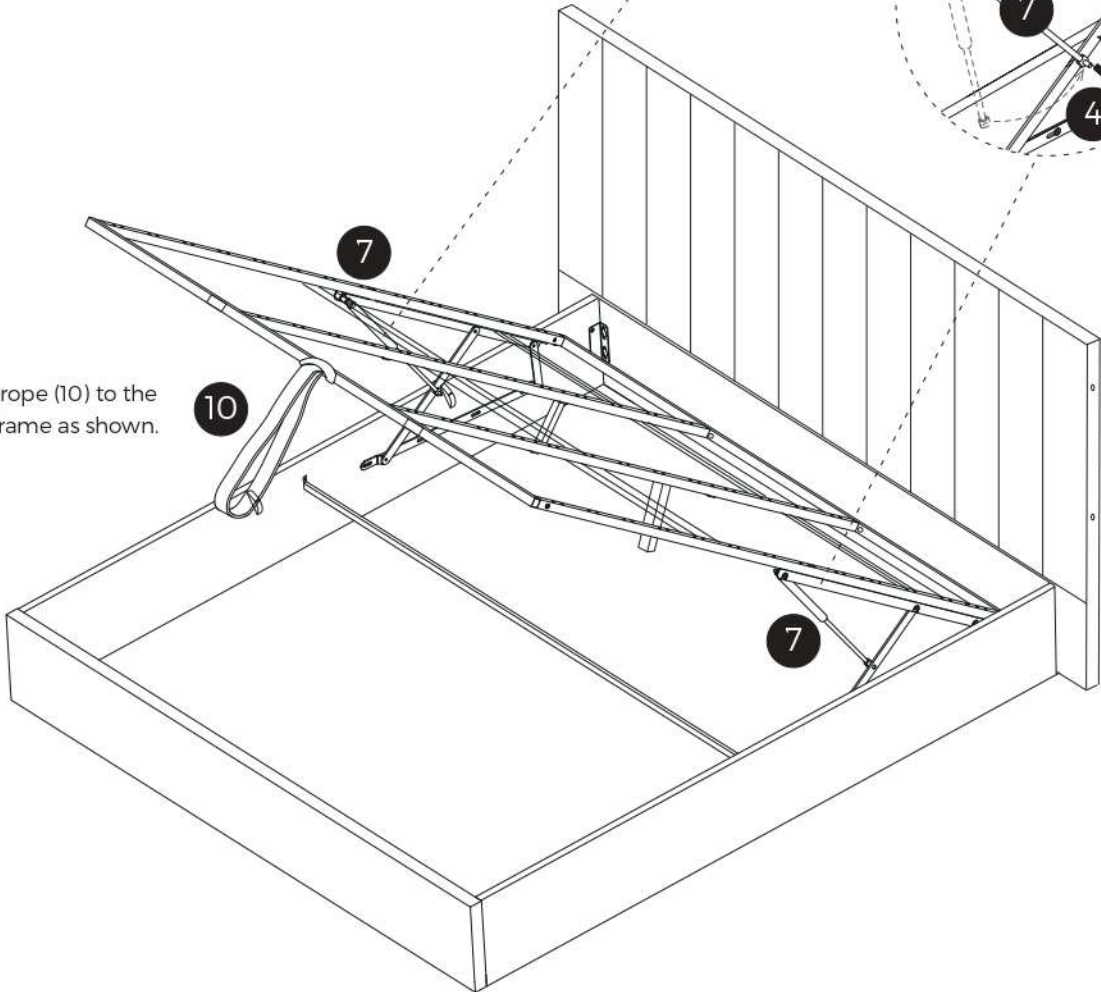

LIFTING THE BED FRAME

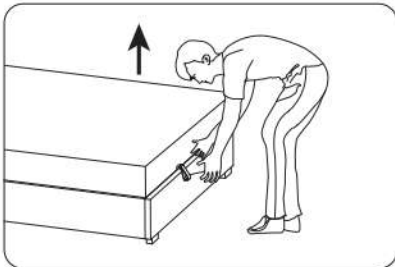

Pull up the rope with both hands to lift the bed frame.

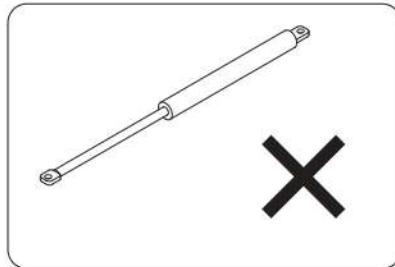

Caution:
Do not use your hands to meddle with the gas strut. Only test the gas strut after it has been attached to the bed frame.

LOWERING THE BED FRAME

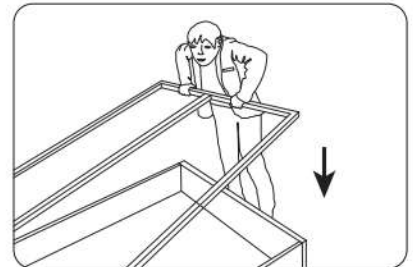

Press the metal frame firmly downwards as shown with both hands. This process will be easier with a mattress on the bed frame.

STEP 9

Part 8

26pcs



Part 14

26pcs



Attach the plastic slat cap (8) to each slat (11). Once all caps are attached, press the caps into the corresponding holes on the side beam (13) as shown.

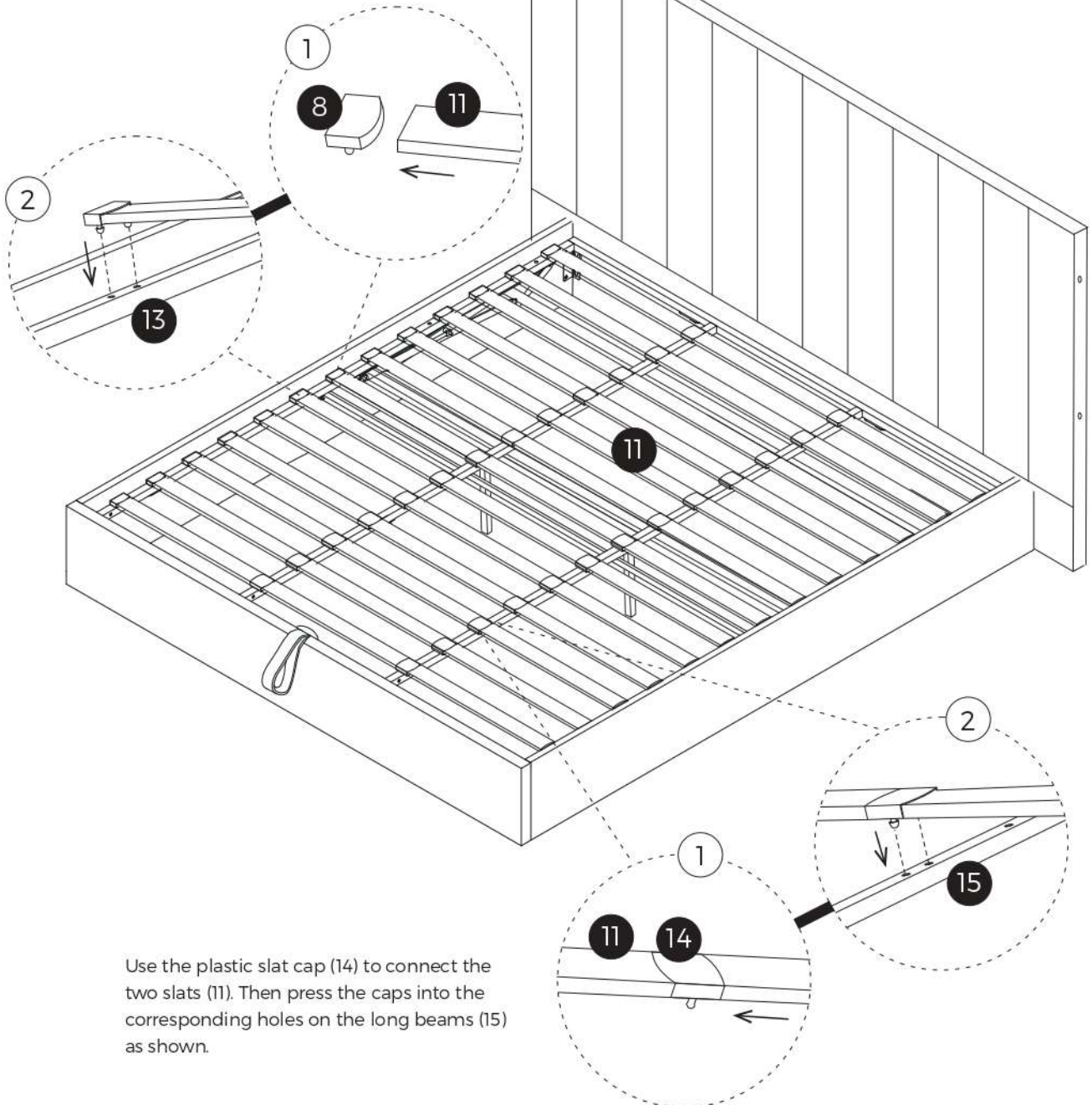

Use the plastic slat cap (14) to connect the two slats (11). Then press the caps into the corresponding holes on the long beams (15) as shown.

STEP 10

Part F

4pcs
M8



Part G

1pc



Part L

4pcs
M8



Part N

4pcs
M8x50mm

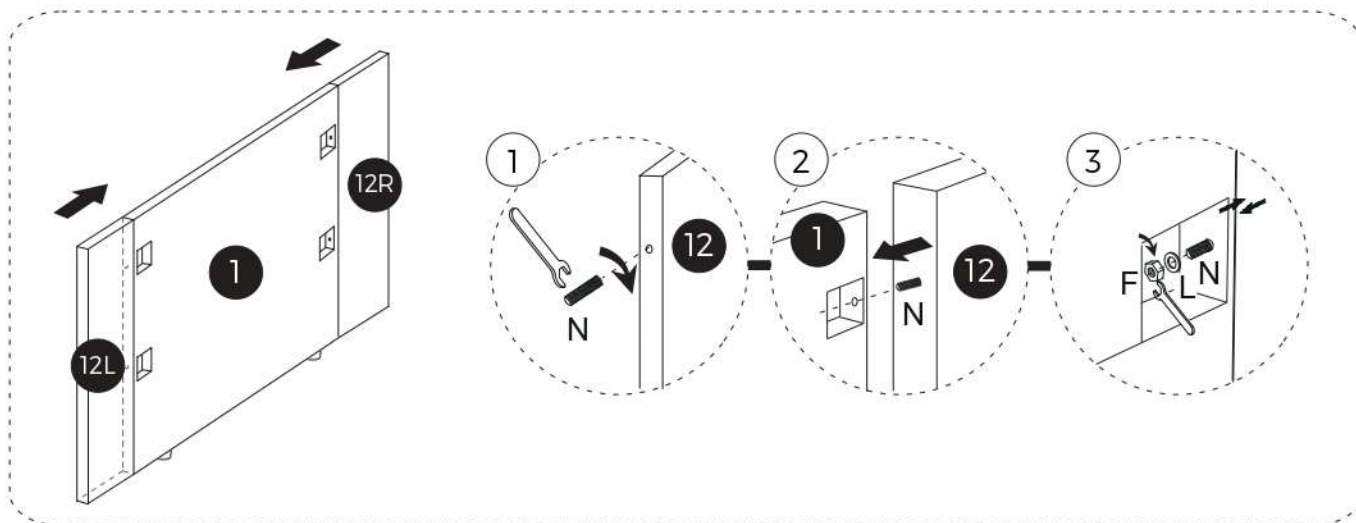

Attach the wing left (12L) and wing right (12R) to the headboard (1) using hardware parts F, L and N with spanner G.

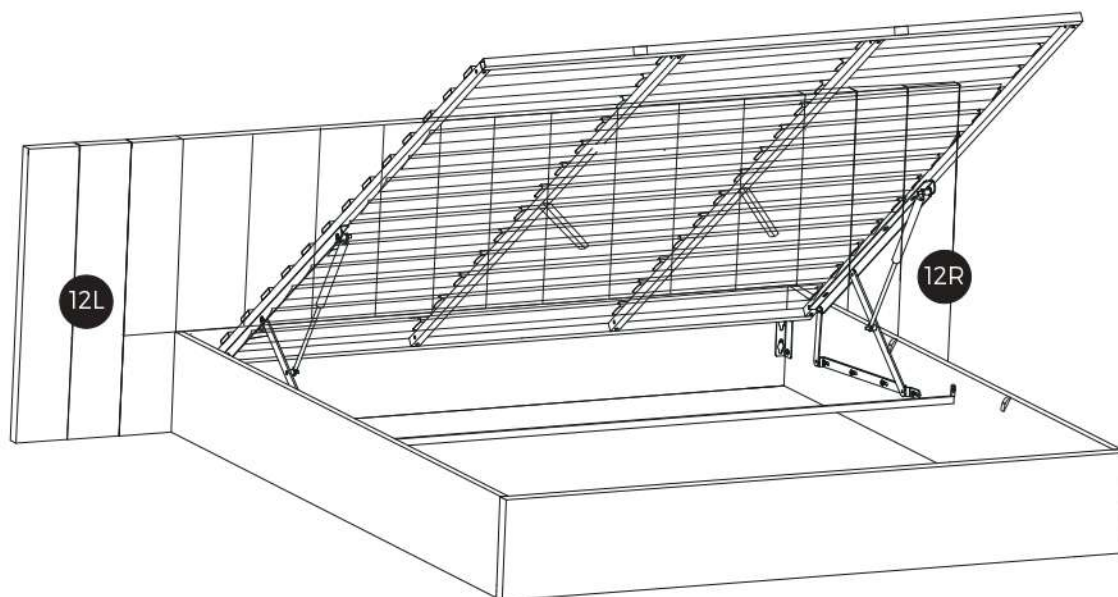

ATTENTION

1. Ensure that the product is properly assembled with all parts and components in place.
2. Re-check and tighten all screws before using the product.

CARE AND MAINTENANCE - FURNITURE

GENERAL

- Periodically check all screws, bolts and joints connections and tighten them if necessary.
- Periodically check for any damage and deteriorated parts and components and seek repairs or replacements if needed.
- Do not allow any liquids to remain on the furniture as this may cause stains and allow the liquid to be absorbed into the finishes and materials. In some cases, this may also cause warping and/or cracking of the materials and finishes. Use coasters and placemats for all food and beverages.
- Do not place hot items, such as dishes, pots and cups, directly on the furniture. Use coasters and placemats for all food and beverages.
- Keep sharp and pointed objects away from furniture to avoid damaging the surface and finish.
- Do not place the furniture near hot objects, heating vents or heating equipment.
- Do not place the furniture in moist areas, such as bathrooms, to avoid water damage.

CLEANING AND CARE

- Dust the furniture regularly using a soft cloth or microfibre duster to prevent dust build-up
- Only wipe and clean with a soft, damp cloth with a mild cleaning detergent.
- Do not use abrasive cleaning materials such as scouring pads and chemical cleaning solvents to avoid damage to finishes and paintwork.
- After using or cleaning a glass table top, wipe it completely dry as leaving the glass unattended when wet may leave water marks that cannot be removed easily.
- For upholstery, vacuum regularly with a soft, non-metallic brush to remove dust and grime and to prevent overall soiling. Follow manufacturer's instructions for spot cleaning.
- If removable, wash upholstery covers periodically. If machine washable, use a cold wash cycle.
- Do not use a dryer. Only air dry the upholstery covers.

ENVIRONMENTAL

- Do not expose the furniture (including outdoor furniture) to direct sunlight. Protect your outdoor furniture with weather-resistant covers, and have curtains and blinds to shield indoor furniture if direct sunlight is unavoidable.
- Bamboo, rattan as well as wood-based furniture are prone to damage and fade with prolonged exposure to extremely high or low humidity conditions. Do not place them in such extreme conditions.
- For outdoor bamboo/rattan furniture, do not place the furniture in shady or moist areas to prevent it from moulding. Bring the furniture indoors during the off season or covered it with weather-resistant covers.

HANDLING

- Do not drag, push or pull furniture when moving them. Lift them up to avoid damage to the furniture legs and scratches on floors.
- Do not sit or stand on the armrests or use the furniture as a stepping stool for safety reasons.
- Do not exceed the recommended weight capacities of the furniture specified.
- Do not use the furniture for any other purpose other than what is intended for.

STORAGE

- Store furniture in a clean, dry environment when not in use.
- If possible, disassemble furniture before storing to save space and prevent damage during transportation.

SPECIFIC CARE

- Engage professional upholstery cleaning services for deeper cleaning if required.
- For genuine leather, suede leather or synthetic leather upholstery, use an appropriate leather conditioner to maintain its suppleness and appearance and prevent drying and cracking. The conditioner also adds a thin protective layer on the leather surface to facilitate easier cleaning.
- If a furniture polish is used for wooden furniture, make sure that it is of low alcohol content.
- To prevent rattan from becoming dry and brittle, spray water on the underside of the furniture piece every six months and wipe down with a dry cloth to remove excess water.
- As an optional protection for bamboo furniture, apply a bamboo sealant/varnish on it for durable protection against scratches, water, UV rays and other weather elements.

CARE AND MAINTENANCE - UPHOLSTERY

CLEANING

- Dust the furniture regularly using a soft cloth or microfibre duster to prevent dust build-up
- Follow the manufacturer's recommendations strictly for cleaning the specific upholstery type.
- Only use cleaning products designed for upholstery and avoid all harsh or abrasive cleaning solvents.
- Vacuum regularly with a soft, non-metallic brush to remove dust and grime and to prevent overall soiling.
- If removable, wash upholstery covers periodically. If machine washable, use a cold wash cycle.
- Do not use a dryer. Only air dry the upholstery covers.
- Engage professional upholstery cleaning services for deeper cleaning if required.

SPILL AND STAINS

- Treat all stains right away. Clean the stains with water, upholstery shampoo or a suitable spot cleaner.
- Do not leave the stains to dry as it will make them harder to clean.
- Wipe up any excess liquid or solids and work from the edge of the stain inwards to avoid spreading.

VELVET / SHERPA / BOUCLE UPHOLSTERY

- Vacuum regularly to prevent the buildup of dirt and dust on the fabric.
- After vacuuming, use a soft-bristle brush to gently brush the fabric to restore the plush appearance.
- Use lukewarm water, mild soap and a non-abrasive cloth to clean. Follow up by drying with a soft cloth, such as a microfibre cloth.
- Only air dry the fabric.
- Do not iron the fabric.
- Position the furniture away from direct sunlight or use curtains and blinds to protect it from excessive exposure.

PU LEATHER UPHOLSTERY

- Vacuum regularly to prevent the buildup of dirt and dust on the fabric.
- Use an appropriate leather conditioner to add a thin protective layer on the leather surface to facilitate easier cleaning.
- Use lukewarm water, mild soap and a non-abrasive cloth to clean. Follow up by drying with a soft cloth, such as a microfibre cloth.
- Do not expose the leather furniture to direct sunlight or high heat to prevent leather cracking.
- Never use general household chemicals to clean leather.
- Be mindful of skin contact on leather as body sweat and oils can break down the top coat seal of leather surfaces.
- When using a leather cleaning product, test it on a small hidden part first to check that there is no adverse reaction with the leather.
- Do not use bleach to remove stains on leather as it will affect the structure of the leather fabric.

POLYESTER UPHOLSTERY

- Use a soft-bristle brush to gently agitate the material and manually unbind dirt from the polyester. Then use a hand-held vacuum cleaner to remove the loose dirt and debris.
- Use lukewarm water, mild soap and a non-abrasive cloth to clean. Follow up by drying with a soft cloth, such as a microfibre cloth.
- If the polyester upholstery has a cleaning code label, use the appropriate cleaning solution to clean it. There are four types of cleaning codes on the label:

W	Liquid solvents can be used to clean this fabric.
S	Only dry-cleaning solutions can be used on this type of fabric.
S/W	Both liquid and dry solvents will work.
X	Only specialised cleaning by professionals.

- When using a cleaning product, test it on a small hidden part first to check that there are no adverse effects with the polyester fabric.
- Use a disinfecting surface cleaner to deodorize and sanitize the furniture as a final step. Choose a surface cleaner that does not have strong chemicals to effectively and safely disinfect the polyester upholstery. Let it air dry when done.