

ASSEMBLY INSTRUCTIONS

Please read the instructions carefully
before assembling and using the product

MBF-GAEL-D/Q

IMPORTANT NOTE:

- * PLACE ALL PARTS ON A CLEAN AND SMOOTH SURFACE SUCH AS A RUG OR CARPET TO AVOID THE PARTS FROM BEING SCRATCHED.
- * KINDLY FOLLOW THE ASSEMBLY INSTRUCTIONS STEP BY STEP.
- * DO NOT TIGHTEN ALL SCREWS UNTIL THE BED IS FULLY SET-UP.

Do not jump on the bed, or it will damage the bed or cause injury!

IMPORTANT NOTICE

When moving the bed, please lift off the ground with two people. DO NOT drag, push or pull the bed across the floor, as this can result in damage to the supporting leg.

ASSEMBLY CHECKLIST



Read through the instructions carefully before starting assembly.

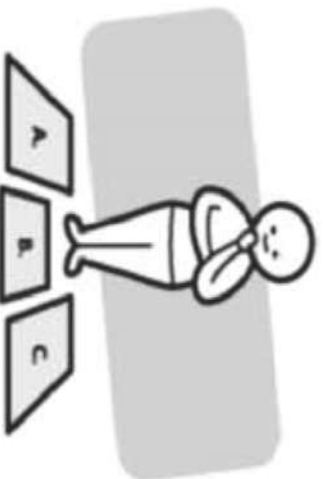

Identify and lay out all parts to familiarise yourself with them.



Make sure that you have the required tools. Do not use power tools.

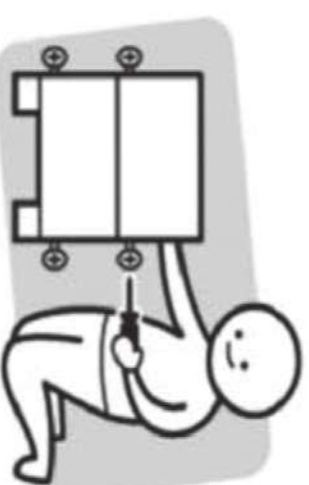





Do not fully tighten all screws until the step or process has been completed.

USEFUL INFORMATION

1. Never use power tools for assembly. They can damage the components or hardware if used incorrectly.
2. The most common mistakes made during assembly are using the wrong hardware or getting components from back to front.
3. Always assemble the product on a soft surface such as a carpet or cardboard to avoid scratching or damaging the surface of the product.

290 × 420mm

A M6x28 18PCS	B M6x20 4PCS	C M7x40 8PCS	D M6x45 8PCS
E M6x50 8PCS		G M8x40 4PCS	H  4PCS
I  2PCS	J  1PCS	K M4x12 2PCS	M  1PC

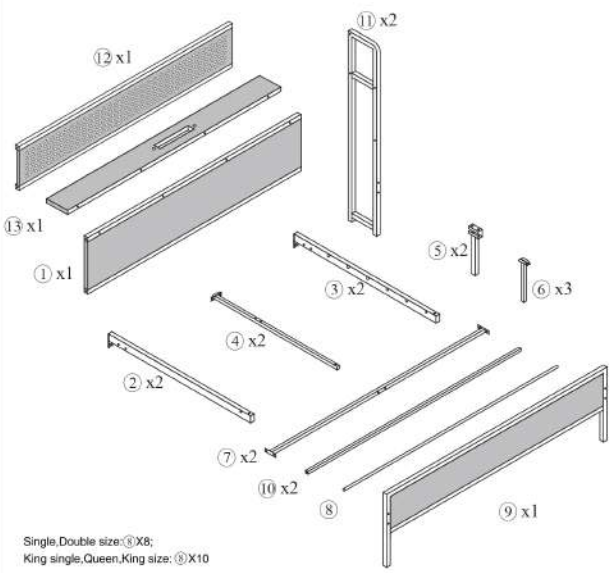

Single, Double size: ⑧X8;
King single, Queen, King size: ⑧X10

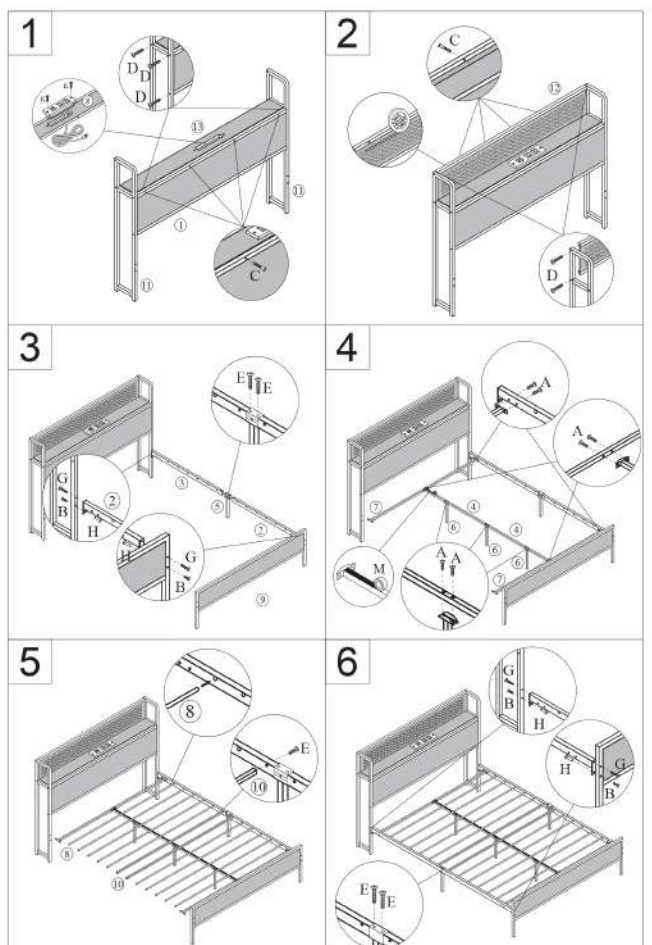

255.00 mm

LED2025-24KEY

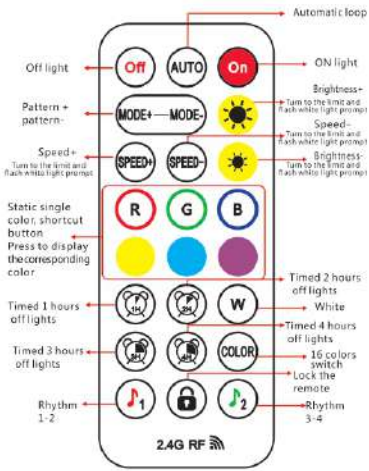

Rhythm 1-2 Single click to switch to 1-2 rhythm mode
 Rhythm 3-4 Click to cycle through the 3-4 rhythm mode
 Remote control lock: After pressing only this remote control the led light.

LotusLantern APP Manual

1. Software Overview

1.1 Overview
 LotusLantern is a mobile APP to control LED strip by both IOS and Android phones. The traditional control ways like infrared, 433MHz, 2.4GHz and others old wired ways will be replaced by mobile phone control way, with convenient, powerful and flexible features. Through this mobile APP, you can not only control the color, brightness and color temperature of the LED strips but also set up all kinds of fancy flash mode. Also this APP can change the light of the LED strip according to the rhythm of the music. This APP can set and control several LED strips through Bluetooth and the operation is very simple, easy to learn and easy to use.

1.2 Features

- Adjust color LED strips with 60,000 colors to change color and brightness and adjust monochrome LED strips to change brightness and color temperature.
- Play music or turn on a sound playback device, you can let the light change the color and brightness with the rhythm of music, the music rhythm (beat).
- Include multiple setting mode for color change and control LED strips without mobile.
- Long distance control with some disposable antennas, and many to many group control mode.
- Once the connection is successful, connect automatically next time.

1.3 Performance
 LotusLantern APP is easy for use as well as great compatible with all kinds of smart phones. After the actual test of hundreds of mobile phones verification, the compatibility is above 95% of mobile phones in the market. APP is small and convenient, it consumes less system resources, so the requirements of the mobile configuration are low. Control delay is small, the operation feels good, light control is smooth with people's actual usage.

2. Operating Environment
 This APP supports various phones of system above Android 4.0 and IOS 8.0. Mobile phone configuration is not limited.

3. Instructions
 Note: Android version and IOS version download and use the same method, there is the Android version as an example.

3.1 APP Download
 Scan the QR code
 IOS and Android systems can download the "LotusLantern" APP by scanning the QR code. Open the browser or other tools with "Scan QR code" function, scan the "LotusLantern" QR code as below.



3.2 App Operation

(1) Click on the LotusLantern APP icon, enter the APP page.

(2) After entering the APP interface, if Bluetooth is not enabled, "an application wants to enable the Bluetooth function of this device." Click [Allow].

(3) Switch to color and brightness interface:
 Click to show the lamp list
 Switch the color wheel
 Display the RGB value
 Click to manual adjustment view

Click to display setting view
 Lamp switch button
 Adjust the color
 Click square icon to adjust the color
 Click to shift the interface

130.00 mm

1

2

3

(4) Click to show the lamp list, view lamp list.
 Bluetooth auto connect after search for devices
 Lamp list
 Status of device connection

(5) Click to RGB manual adjustment view.
 (6) Switch to the music interface.
 Scroll the selection mode
 Adjust speed
 Adjust brightness

4

(7) Switch to the music rhythm interface:
 Previous song, Pause/Play, Next song
 Play mode
 Music List

(8) Switch to the online music interface:
 Status of device connection

(9) Switch to the microphone rhythm interface:
 Music rhythm through of phone microphone
 Switch phone microphone and external microphone

5

Music rhythm through the microphone on the product.
 Switch phone microphone and external microphone
 A style rhythm
 Change the sensitivity of MIC to match the sound

(10) Switch to the schedule interface:
 Set the time of Light-On
 Set the time of Light-Off
 Enable or disable the Light-On function
 Repeat setting
 No selection for once Light-On
 Enable or disable the Light-Off function
 Repeat setting
 No selection for once Light-Off

(11) Switch to the modify an scenario interface:
 Click to save the new assignment
 Change the real color of this line

6