

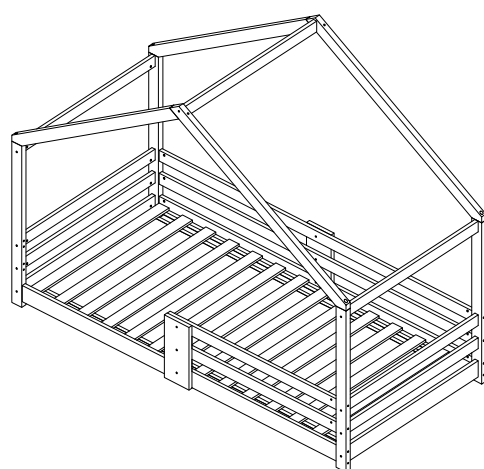

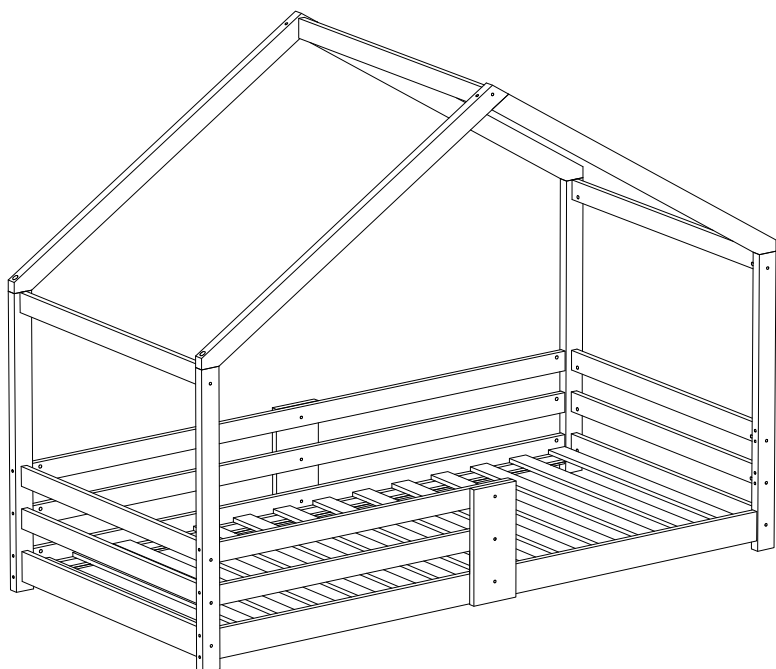





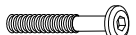

# WOODEN BED FRAME

## MODEL:BF-W-A4-WH/WD



A		M6*100	14	G		M6	6
B		M6*30	6	H		M6*70	18
C		8*30	38	D			18
D			14	J		4*30	28
E		6* 70	4	J		4 mm	1
F		6* 100	2				

# ASSEMBLY INSTRUCTIONS

Please read the instructions carefully  
before assembling and using the product

### \*IMPORTANT NOTICE\*

When moving the bed, please lift off the ground with two people. DO NOT drag, push or pull the bed across the floor, as this can result in damage to the supporting leg.

# ASSEMBLY CHECKLIST



Read through the instructions carefully before starting assembly.



Make sure that you have the required tools. Do not use power tools.



Identify and lay out all parts to familiarise yourself with them.



Do not fully tighten all screws until the step or process has been completed.

## USEFUL INFORMATION

1. Never use power tools for assembly. They can damage the components or hardware if used incorrectly.
2. The most common mistakes made during assembly are using the wrong hardware or getting components from back to front.
3. Always assemble the product on a soft surface such as a carpet or cardboard to avoid scratching or damaging the surface of the product.

# STEP:1

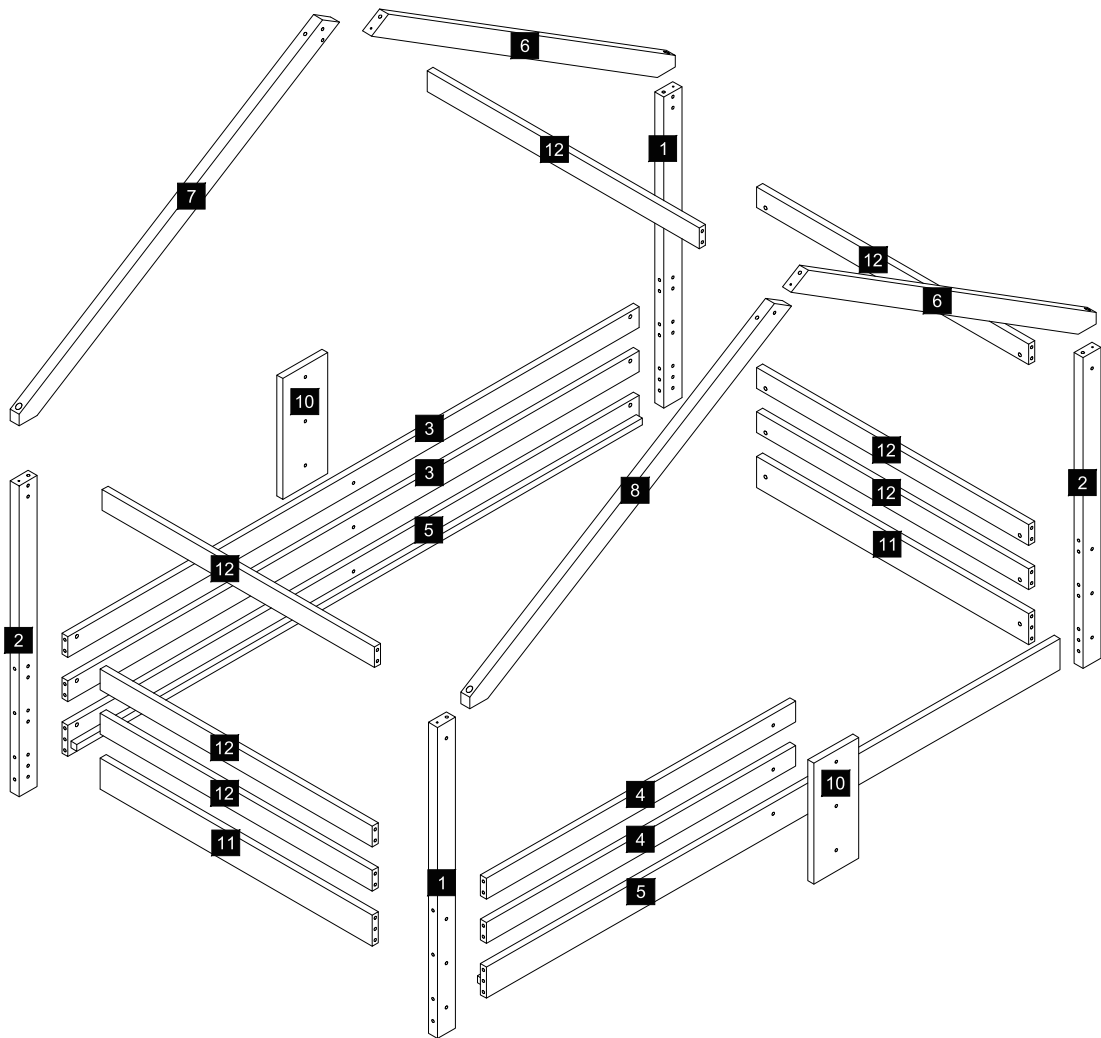



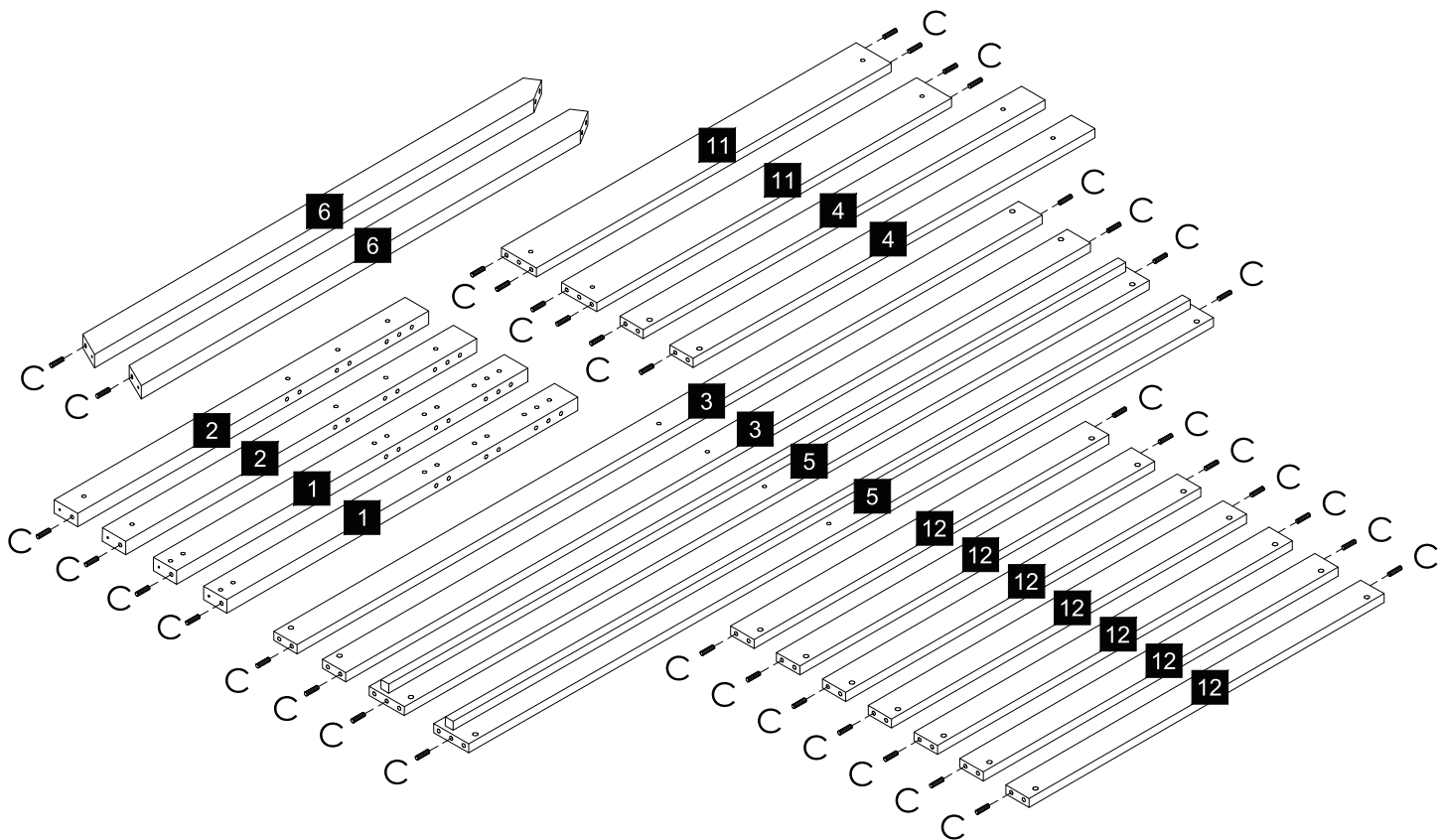



# STEP:2

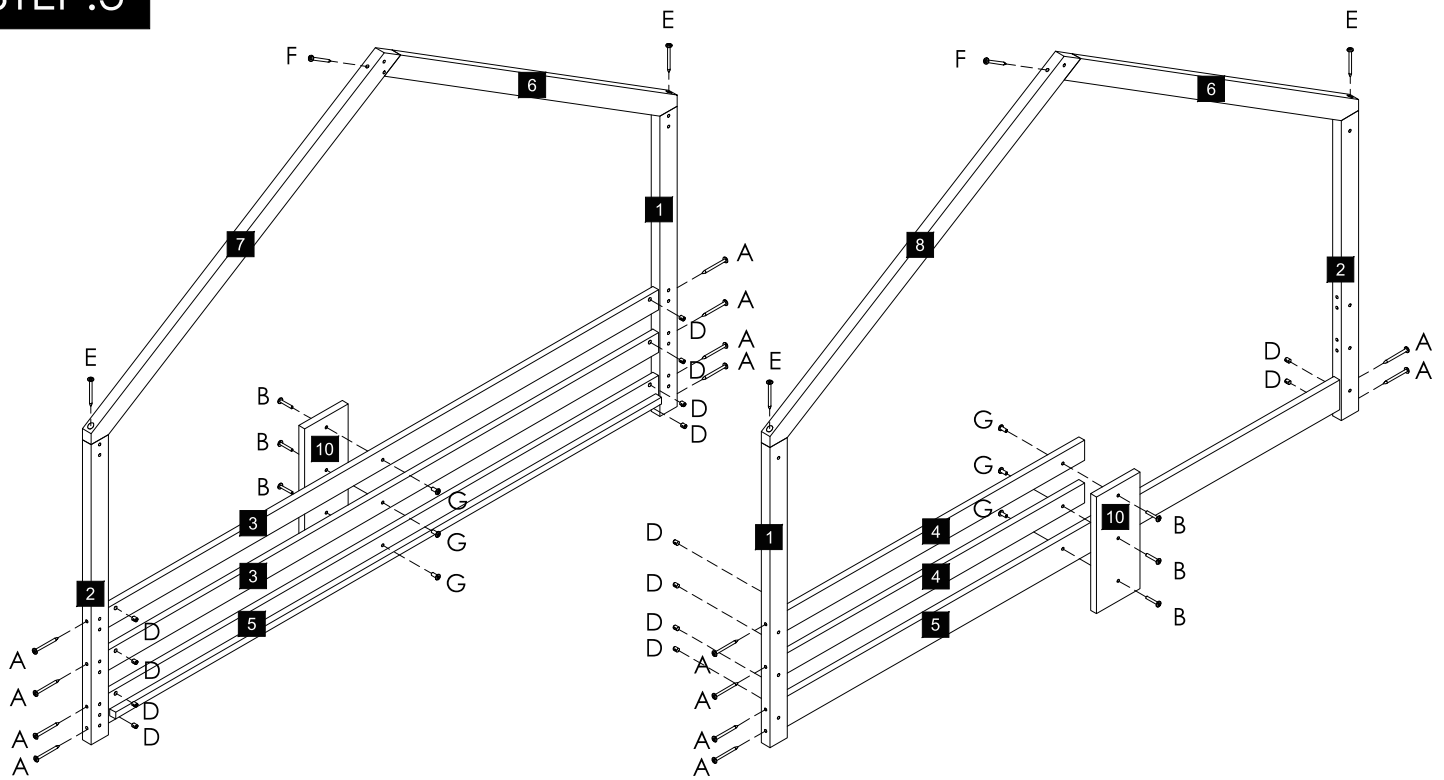

C		8*30	38
---	---	------	----



# STEP:3

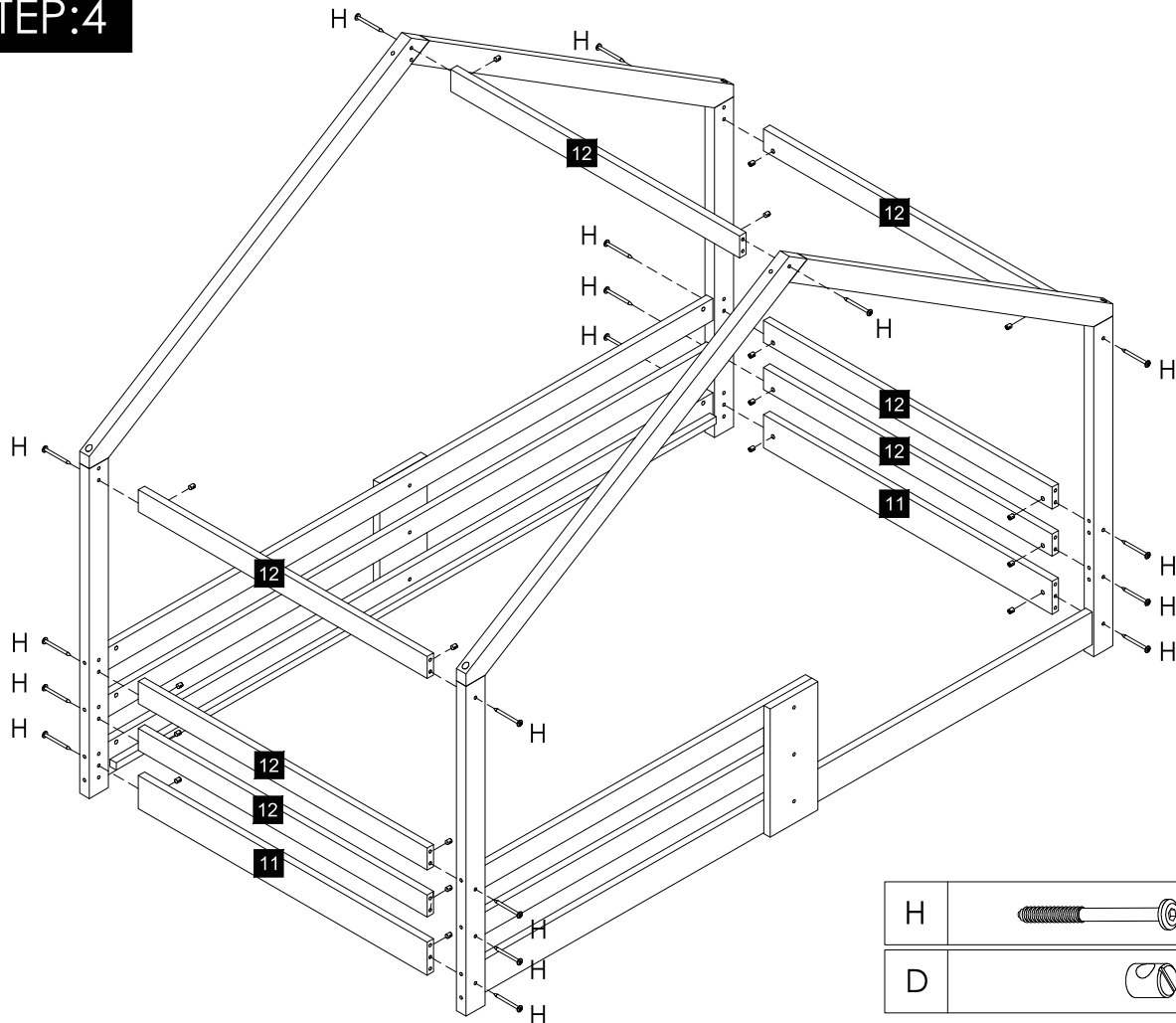

A		M6*100	14	E		6* 70	4
B		M6*30	6	F		6* 100	2
D			14	G		M6	6

# STEP:4



H		M6*70	18
D			18

**STEP:5**

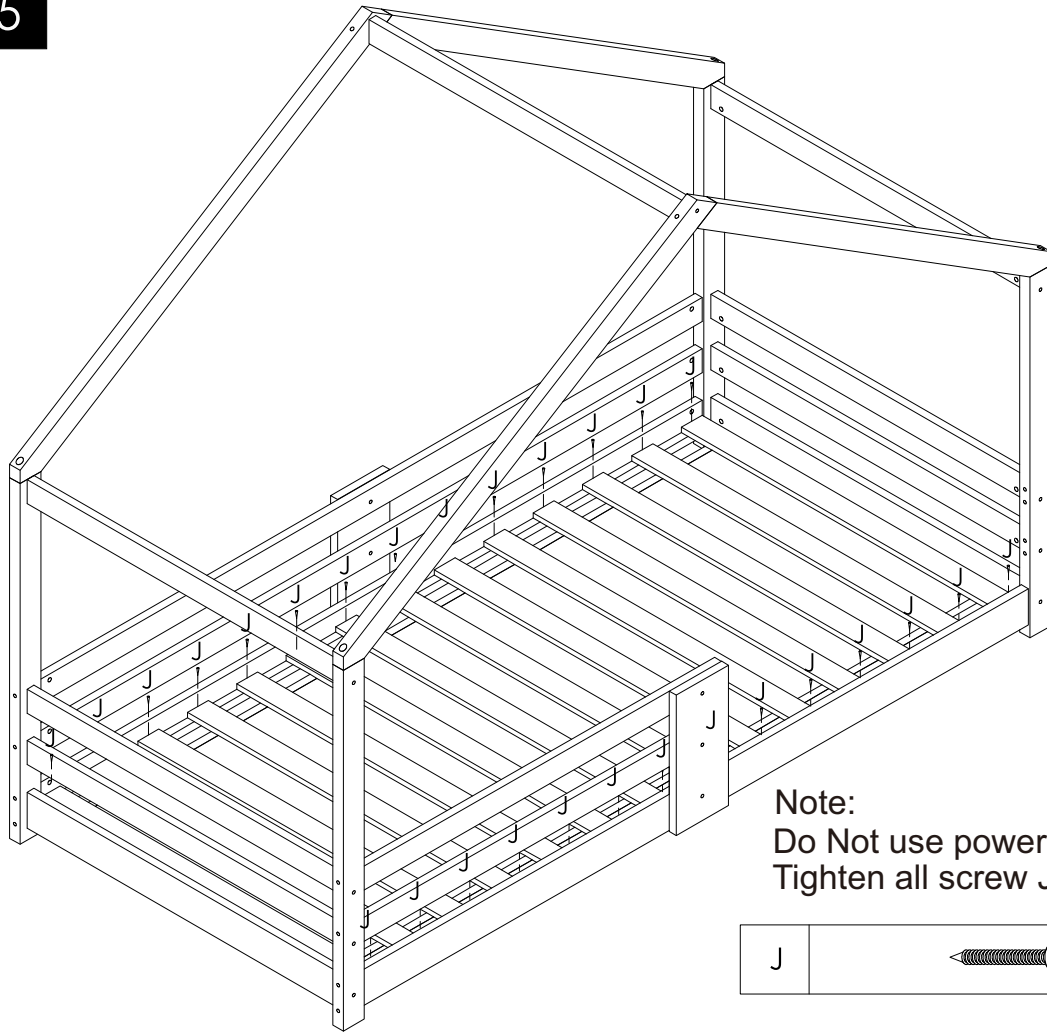









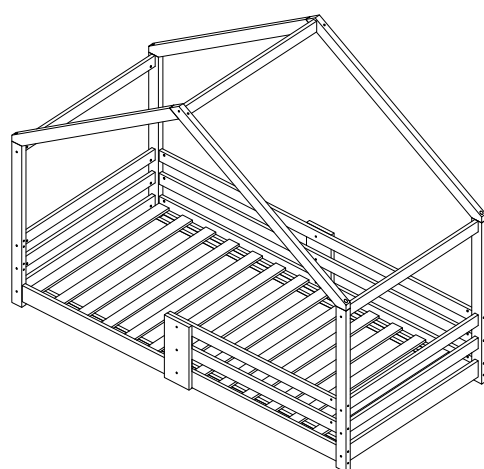
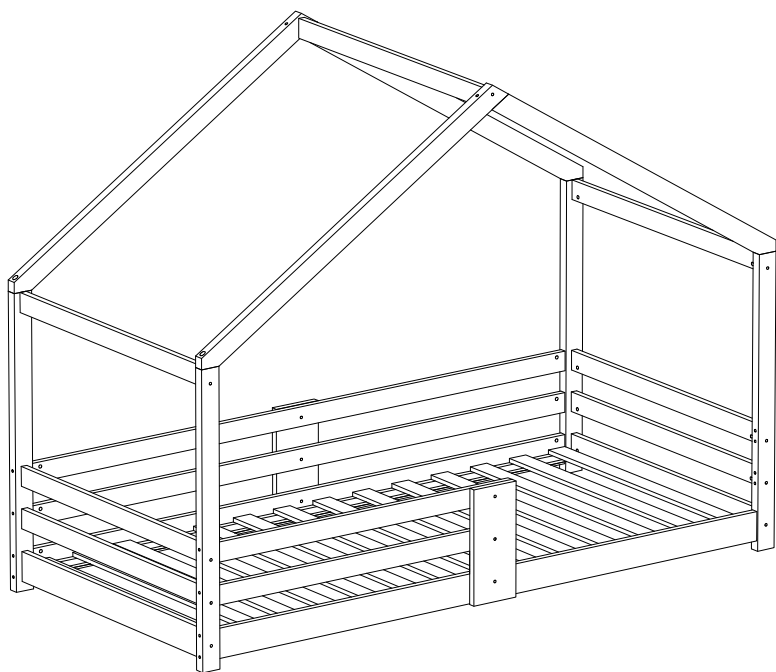

**Note:**  
Do Not use power tools!  
Tighten all screw J to fix all bed slats

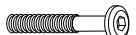
J		4*30	28
---	---	------	----

# WOODEN BED FRAME

## MODEL:BF-W-A4-WH/WD



A		M6*100	14	G		M6	6
B		M6*30	6	H		M6*70	18
C		8*30	38	D			18
D			14	J		4*30	28
E		6* 70	4	J		4 mm	1
F		6* 100	2				

# ASSEMBLY INSTRUCTIONS

Please read the instructions carefully  
before assembling and using the product

### \*IMPORTANT NOTICE\*

When moving the bed, please lift off the ground with two people. DO NOT drag, push or pull the bed across the floor, as this can result in damage to the supporting leg.

# ASSEMBLY CHECKLIST



Read through the instructions carefully before starting assembly.

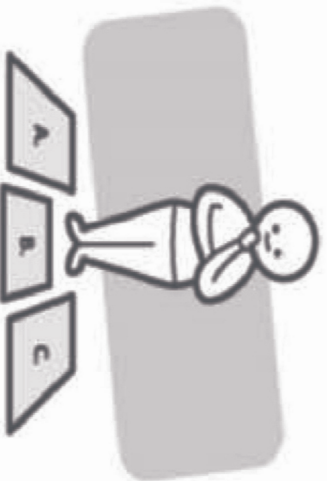

Identify and lay out all parts to familiarise yourself with them.



Make sure that you have the required tools. Do not use power tools.

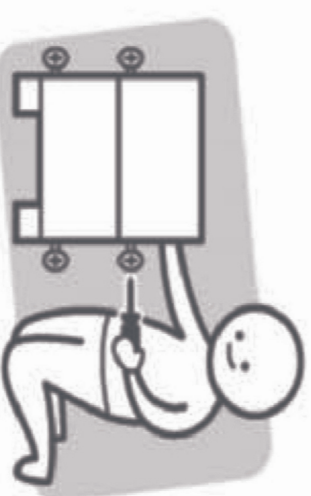

Do not fully tighten all screws until the step or process has been completed.

## USEFUL INFORMATION

1. Never use power tools for assembly. They can damage the components or hardware if used incorrectly.
2. The most common mistakes made during assembly are using the wrong hardware or getting components from back to front.
3. Always assemble the product on a soft surface such as a carpet or cardboard to avoid scratching or damaging the surface of the product.

# STEP:1

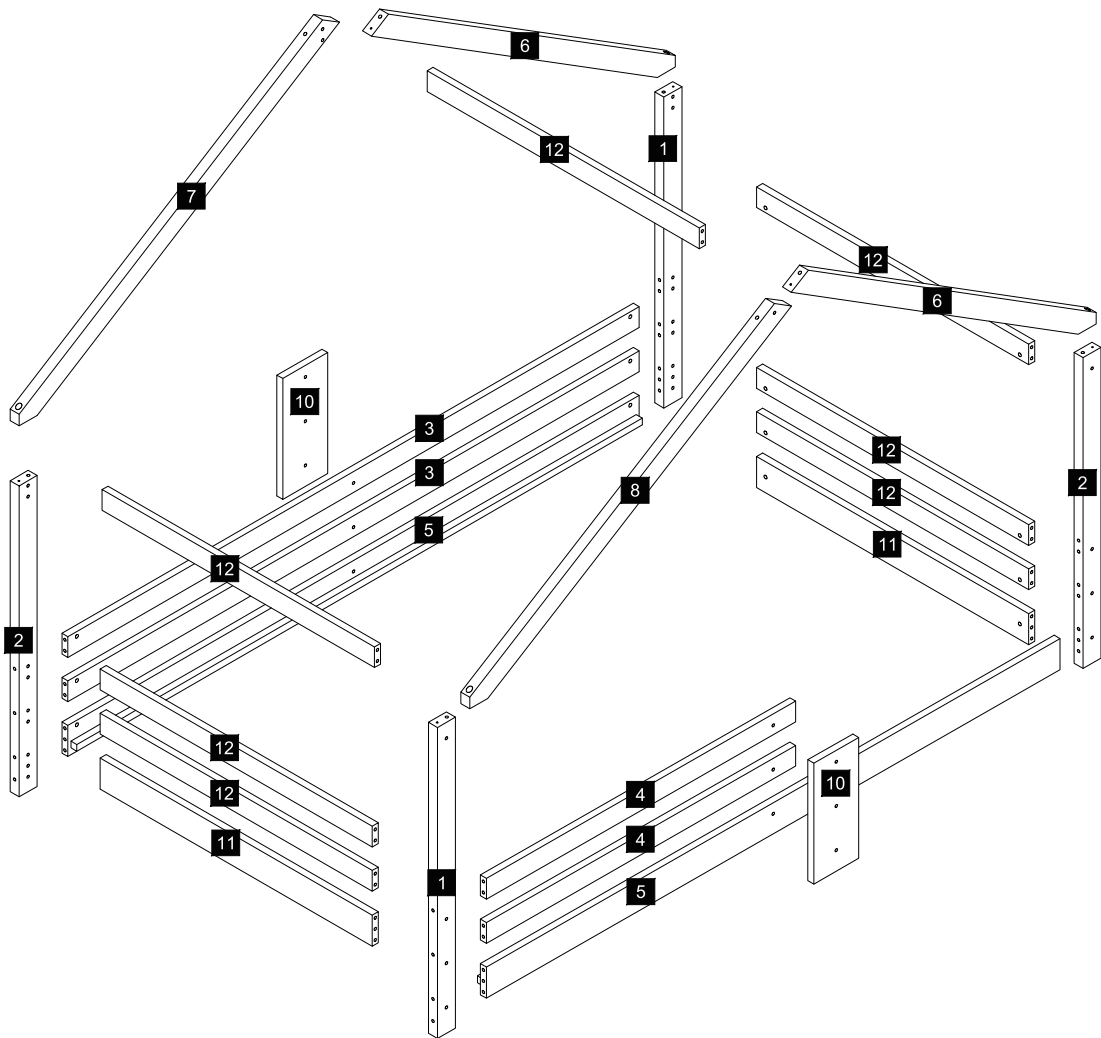



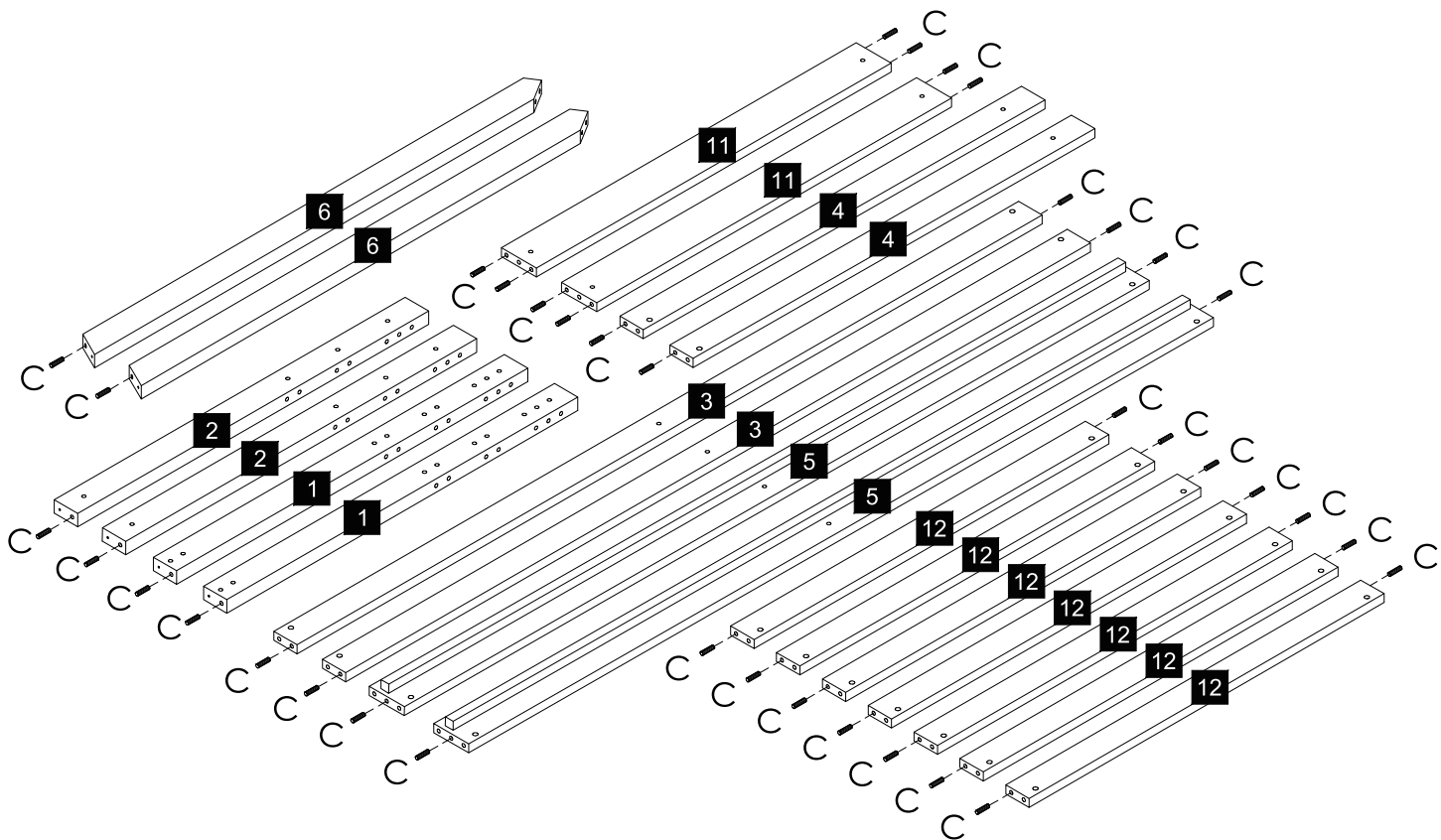



# STEP:2

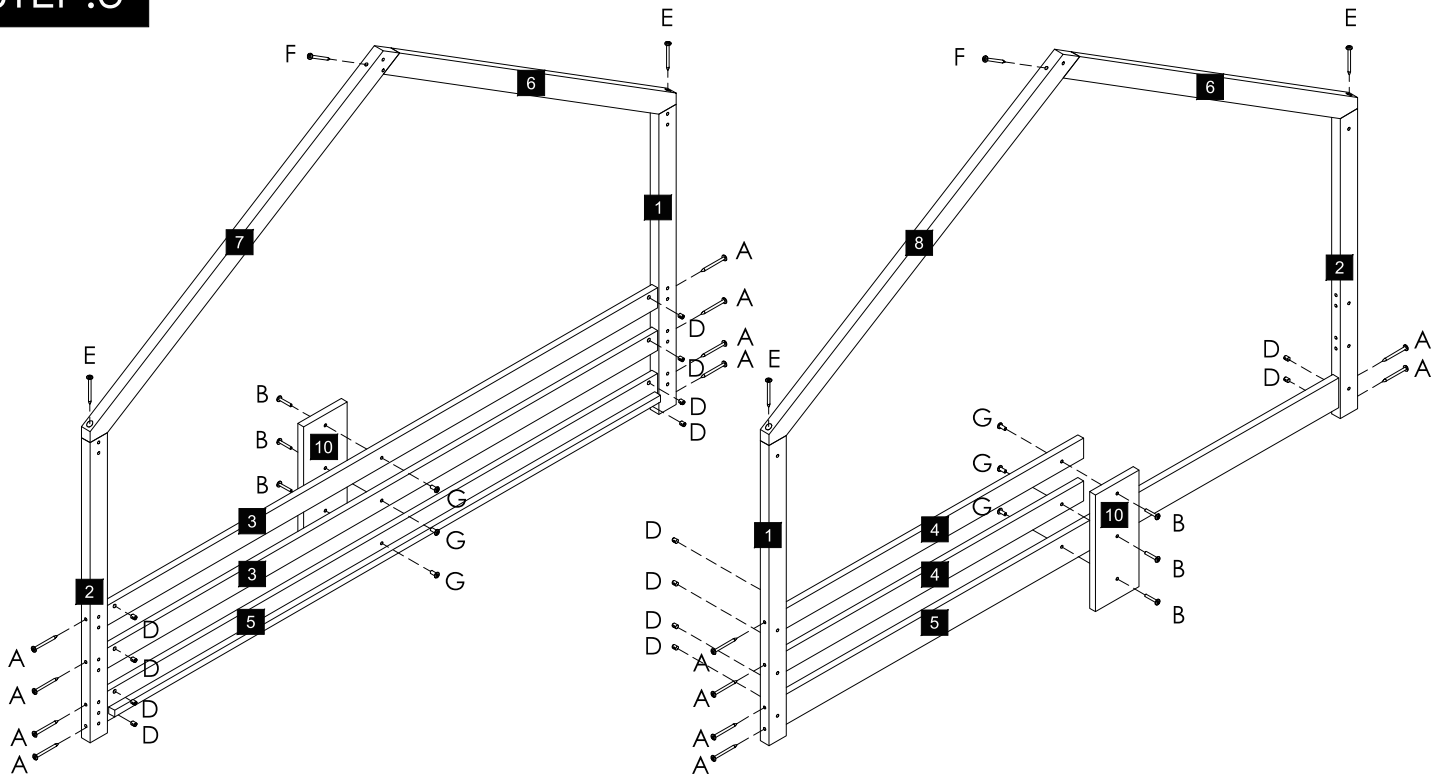

C		8*30	38
---	---	------	----



# STEP:3

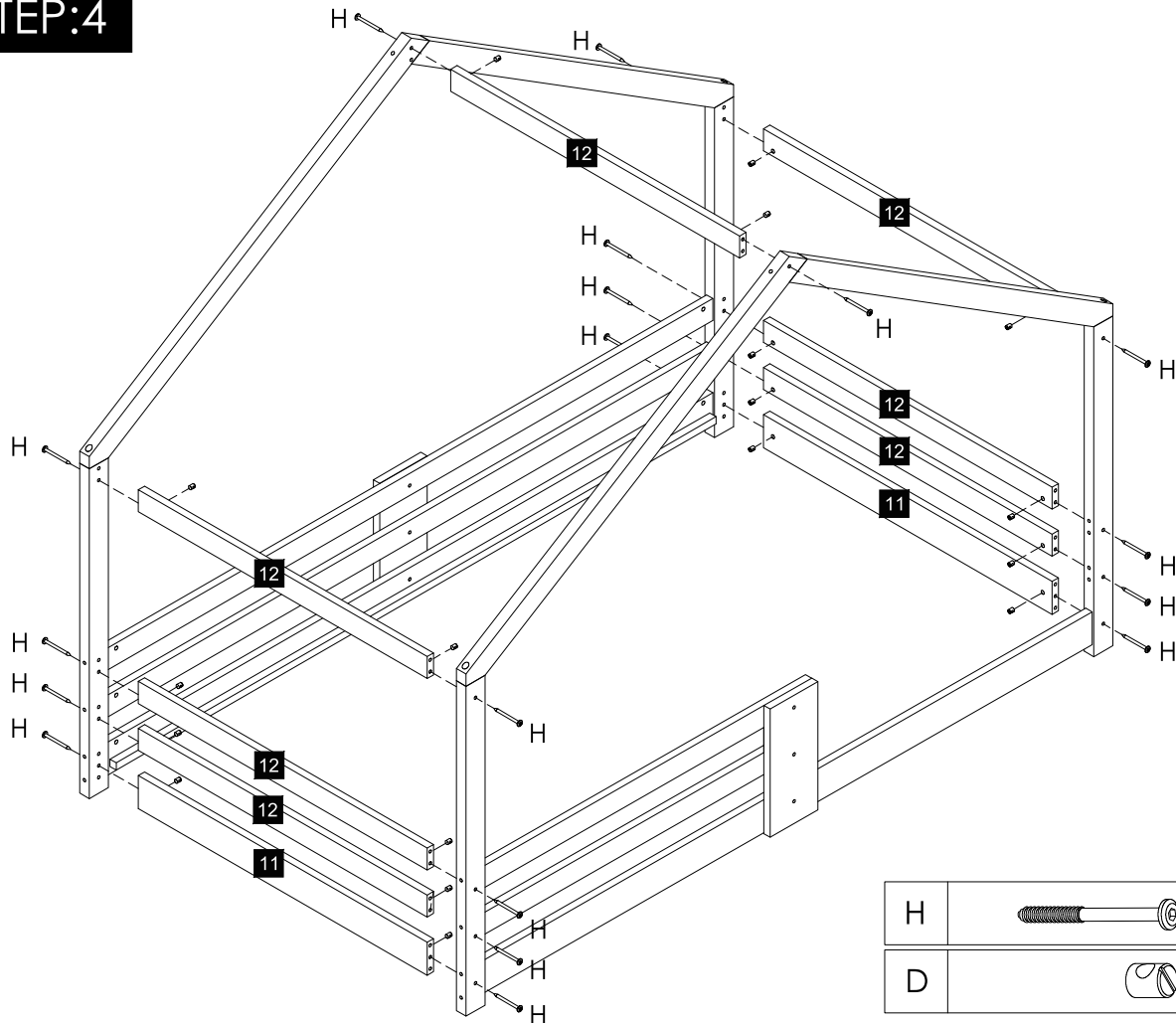

A		M6*100	14	E		6* 70	4
B		M6*30	6	F		6* 100	2
D			14	G		M6	6

# STEP:4



H		M6*70	18
D			18

**STEP:5**

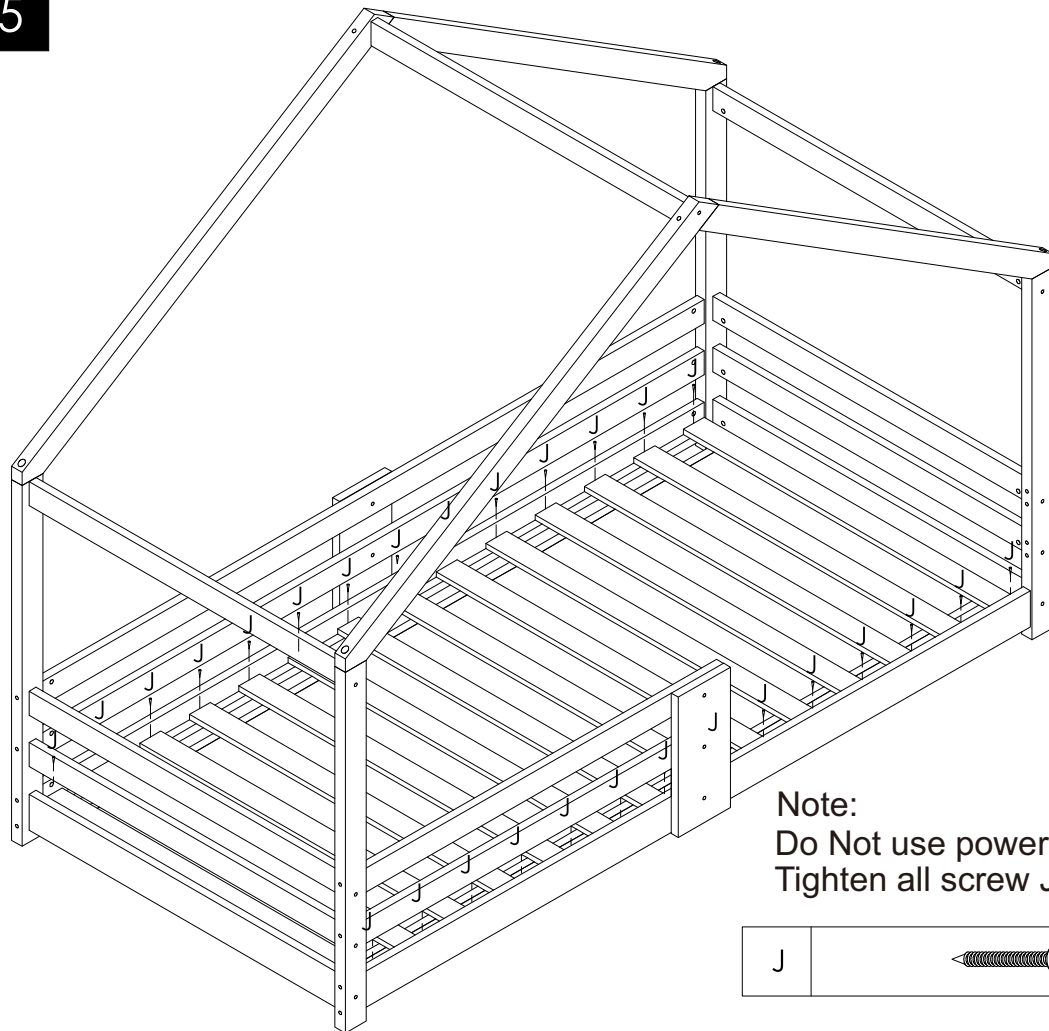

**Note:**  
Do Not use power tools!  
Tighten all screw J to fix all bed slats

J		4*30	28
---	---	------	----