

OUTDOOR RECLINER

MODEL: ODR-FW-CHFTR-BK/GY

ASSEMBLY INSTRUCTIONS

ASSEMBLY TIPS

- Do not tighten screws until all screws are lined up with the holes.
- If holes are not aligned, loosen some tightened screws and adjust accordingly. Tighten screws diagonally across the product.
- If the product is uneven on the ground after assembly, loosen some screws and press down the product so that all legs are touching the ground. Then tighten screws.

PART	QTY	PART	QTY
A	1	B	1
C	1	D	1
E	1	F	1
G	1	H	4
I	4	J	4
K	4	L	2
M	2	N	2
O	12	P	8
Q	1		

STEP 1: Connect the legs (A and B) with the connecting brace (F).

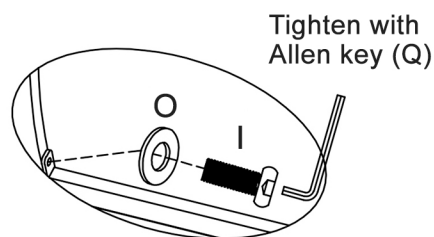
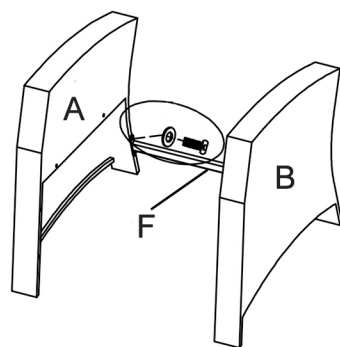

Hardware
I x4pcs
O x4pcs

STEP 2: Attach seat (C) to both legs (A and B).

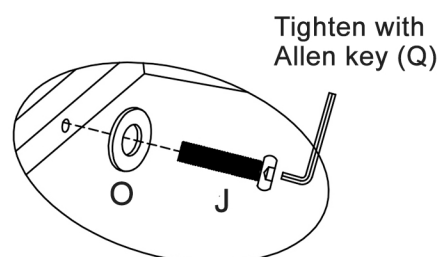
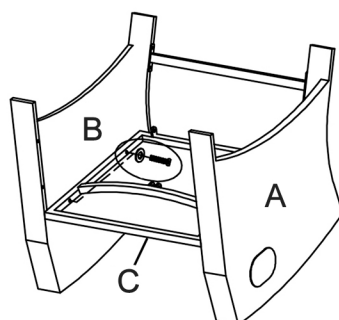

Hardware
J x4pcs
O x4pcs

STEP 3: Connect the front panel (E) to the legs (A and B).

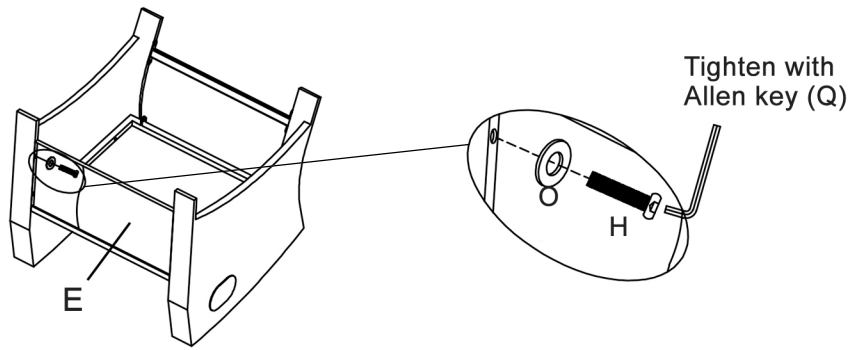

Hardware
H x4pcs
O x4pcs

STEP 4: Attach the backrest (D) to the seat (C).

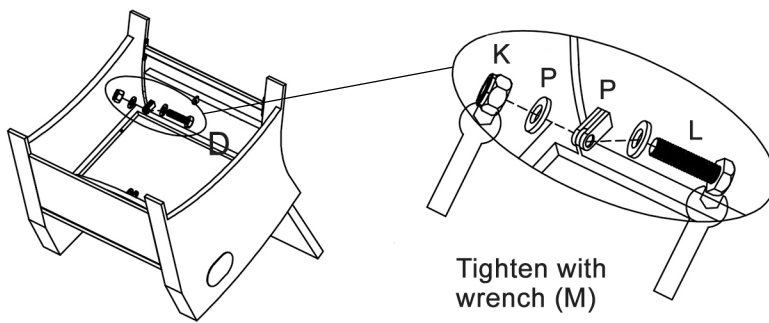

Hardware
L x2pcs
K x2pcs
P x4pcs

STEP 5: Attach the gas hydraulic (from A) to the seat (C) and backrest (D).

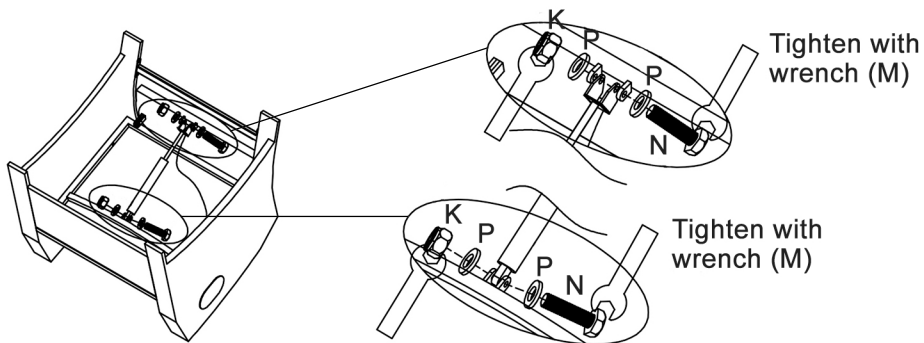

Hardware
N x2pcs
K x2pcs
P x4pcs

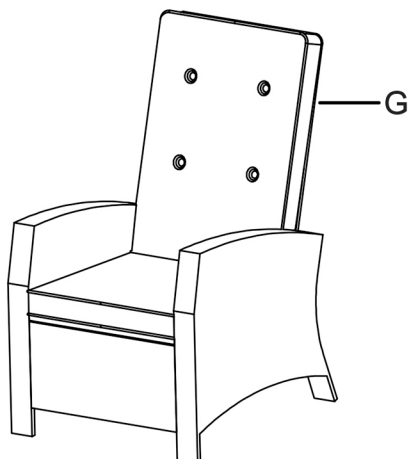





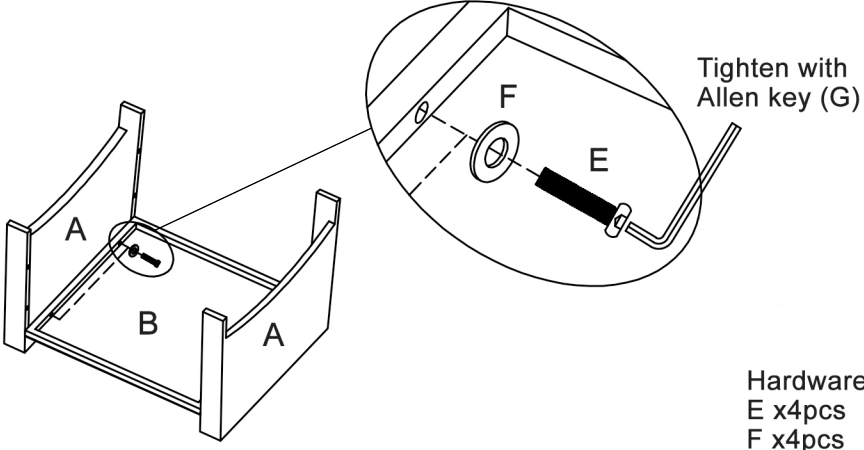

STEP 6: Place the seat cushion (G) onto the assembled recliner.

FOOTSTOOL

MODEL: ODR-FW-CHFTR

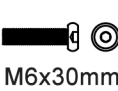
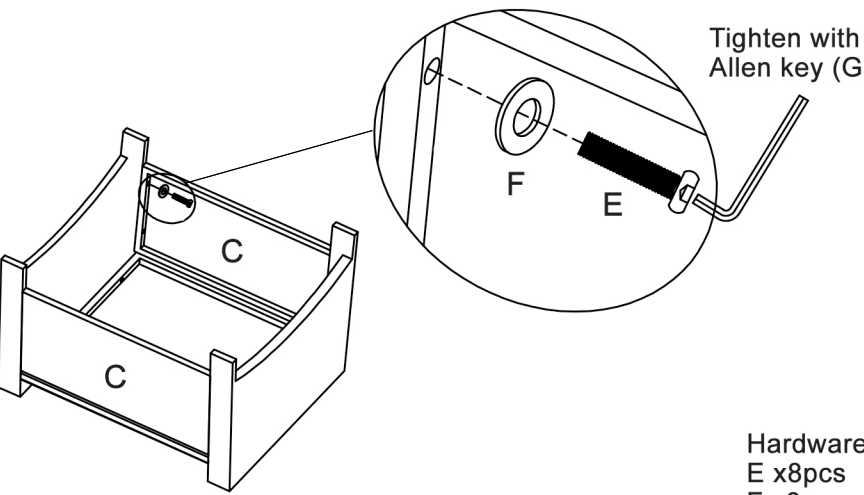

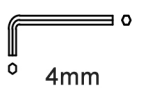
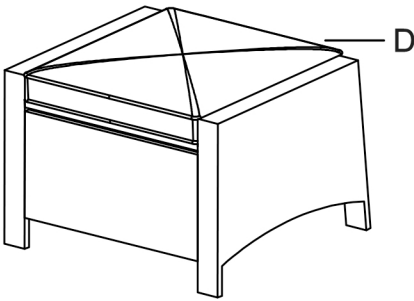

ASSEMBLY INSTRUCTIONS

PART		QTY	
A		2	STEP 1: Attach the legs (A) to the seat (B)  <p>Hardware E x4pcs F x4pcs</p>
B		1	
C		2	
D		1	
E	 M6x30mm	12	STEP 2: Attach the panels (C) to the legs (A).  <p>Hardware E x8pcs F x8pcs</p>
F		12	
G	 4mm	1	
ASSEMBLY TIPS <ul style="list-style-type: none"> • Do not tighten screws until all screws are lined up with the holes. • If holes are not aligned, loosen some tightened screws and adjust accordingly. Tighten screws diagonally across the product. • If the product is uneven on the ground after assembly, loosen some screws and press down the product so that all legs are touching the ground. The tighten screws. 			STEP 3: Place the cushion (D) onto the seat (B). 

COFFEE TABLE

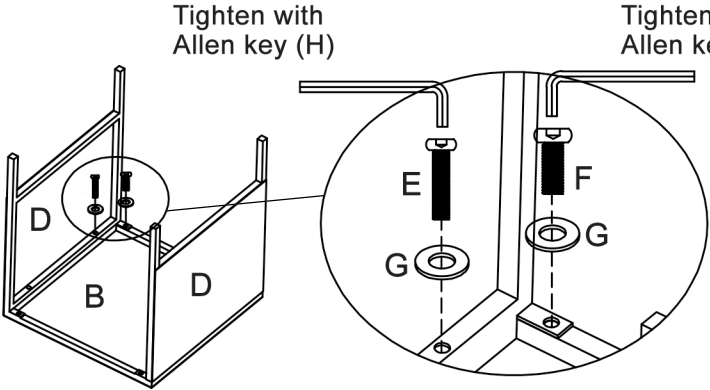
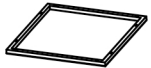
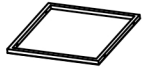
MODEL: ODR-FW-TB-BK/GY

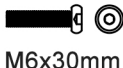
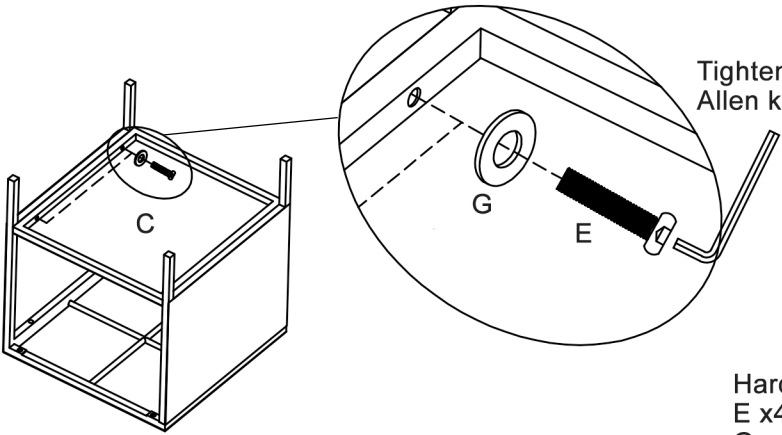
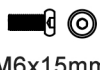
ASSEMBLY INSTRUCTIONS

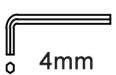
PART		QTY	
A	 glass	1	STEP 1: Attach the legs (D) to the seat (B)  <p>Tighten with Allen key (H)</p> <p>Tighten with Allen key (H)</p> <p>Hardware E x4pcs F x4pcs G x8pcs</p>
B		1	
C		1	
D		2	
E	 M6x30mm	8	STEP 2: Attach the bottom shelf (C) to the table legs (D)  <p>Tighten with Allen key (H)</p> <p>Hardware E x4pcs G x4pcs</p>
F	 M6x15mm	4	
G		12	
H	 4mm	1	
ASSEMBLY TIPS <ul style="list-style-type: none"> Do not tighten screws until all screws are lined up with the holes. If holes are not aligned, loosen some tightened screws and adjust accordingly. Tighten screws diagonally across the product. If the product is uneven on the ground after assembly, loosen some screws and press down the product so that all legs are touching the ground. The tighten screws. 			STEP 3: Place the glass top (A) on the coffee table. 