



ASSEMBLY DIAGRAM Version 2.0

KLON BED





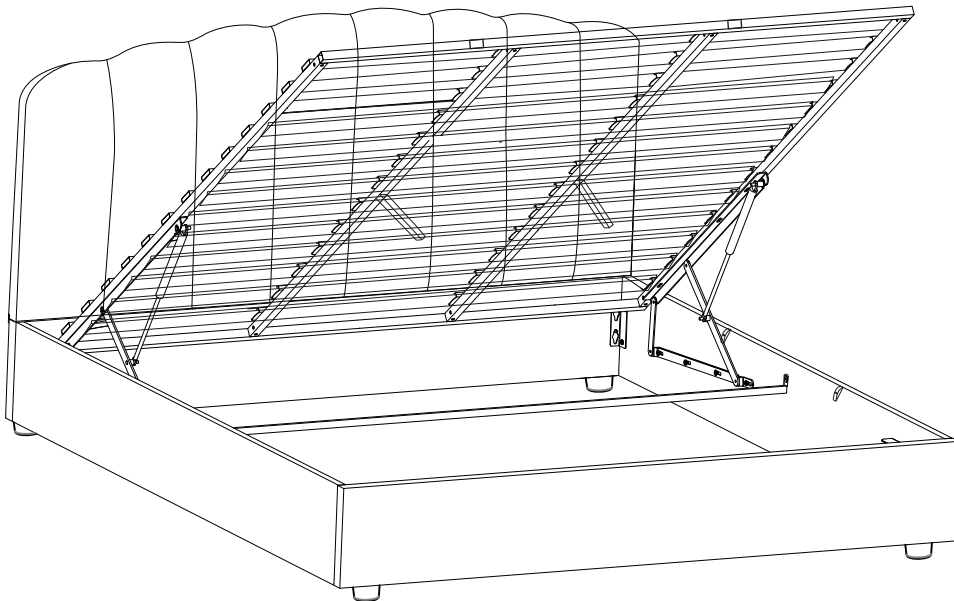

BF-B-KLON-K

IMPORTANT NOTE:

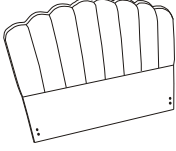
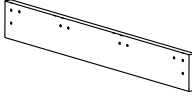
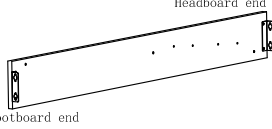
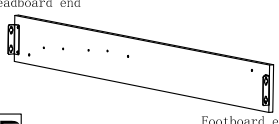
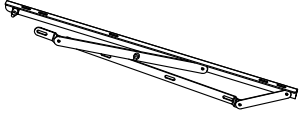
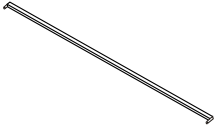
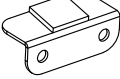
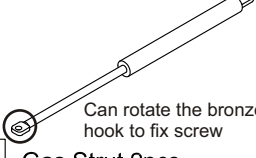
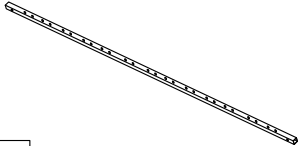
- *PLACE ALL PARTS ON A CLEAN AND SMOOTH SURFACE SUCH AS A RUG OR CARPET TO AVOID THE PARTS FROM BEING SCRATCHED.
- *KINDLY FOLLOW THE ASSEMBLY INSTRUCTIONS STEP BY STEP.
- *DO NOT TIGHTEN ALL SCREWS UNTIL THE BED IS FULLY SET-UP.

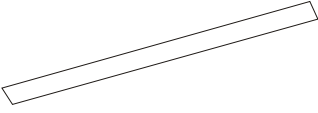



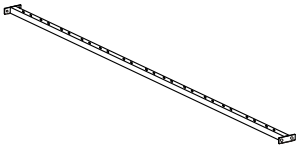
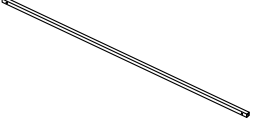
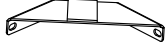
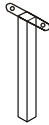



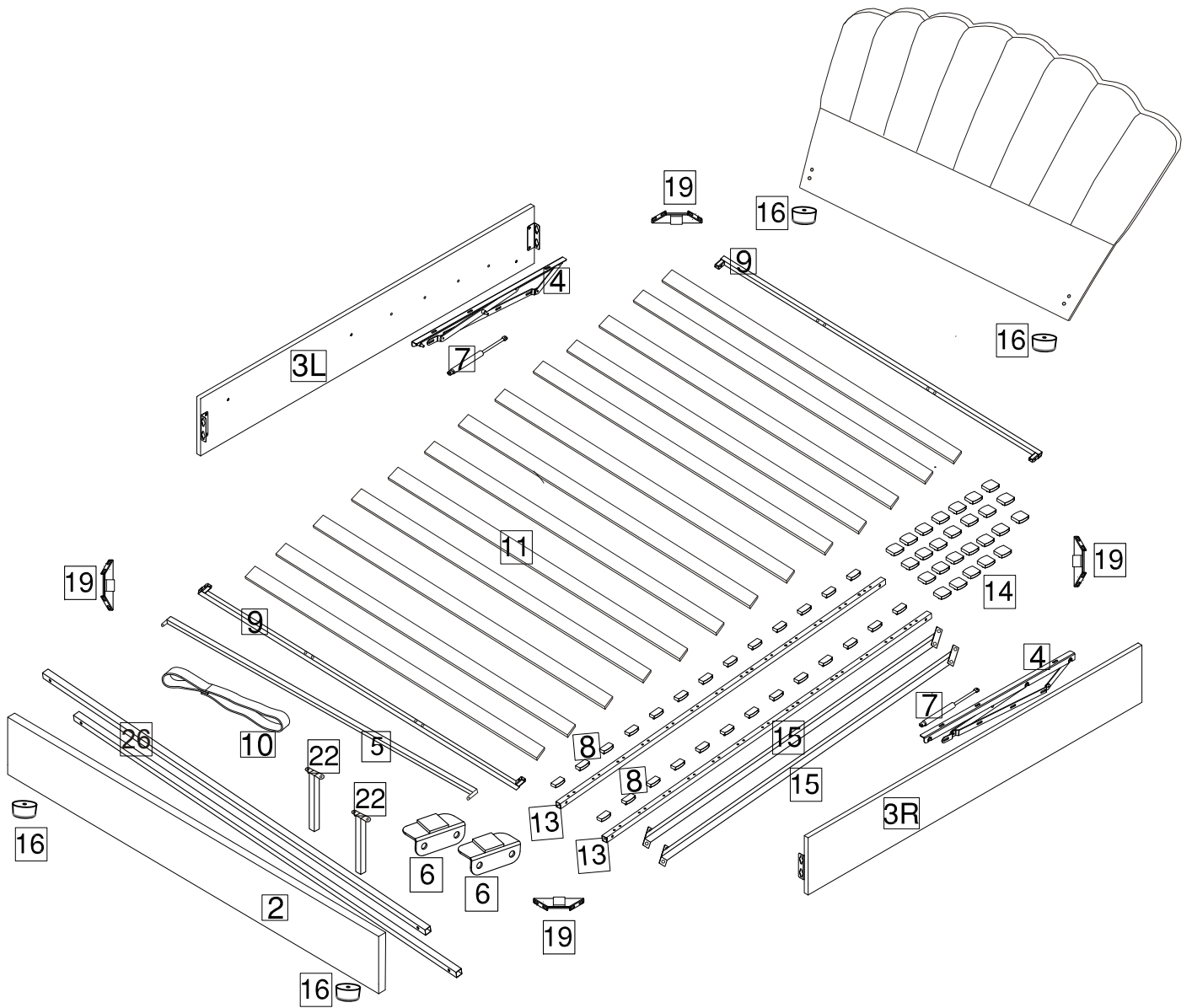







Parts List

 <p>1 Headboard 1pc</p>	 <p>2 Footboard 1pc</p>	 <p>3L Side Rail Left 1PC</p>	 <p>3R Side Rail Right 1PC</p>
 <p>4 Hinge 2pcs</p>	 <p>5 Cross bar 1pc</p>	 <p>6 Angle Iron 2pcs</p>	 <p>7 Gas Strut 2pcs Can rotate the bronze hook to fix screw</p>
 <p>13 Bedstead Side Pipe 2pcs</p>	 <p>9 Front And Rear Frameworks 2pcs</p>	 <p>10 Rope 1pc</p>	 <p>11 Slats 13pcs</p>
 <p>16 Leg 4pcs</p>	 <p>8 Plastic Slat Caps 26pcs</p>	 <p>14 Centre Slat Caps 26pcs</p>	 <p>15 Reinforced Pipe 2pcs</p>
 <p>26 Connect bar 2pcs</p>	 <p>19 Metal Corner Bracket 4pcs</p>	 <p>22 Centre Support Leg 2pcs</p>	

Parts



Fittings

 A M8X40mm Bolt 22 pcs	 B M8X30mm Bolt 12 pcs	 C M8X16mm Bolt 4 pcs	 D Plastic washer 8 pcs	 E M6X16mm Bolt 10 pcs	 F M8 nuts 18 pcs
 G Spanner 1 pc	 H M8 Allen Key 1 pc	 L Flat Washer 8 pcs	 P 4.0X50mm Screw 4 pcs	 W M6 Allen Key 1 pc	 Y M8X65mm Bolt 4 pcs
 Q 3.0X16mm Screw 8 pcs	 O Plastic Spacer 4 pcs	 M Spring washer 8 pcs			

Please refer to the instruction words before installing it.

Step 1:

- Ⓟ 4PCS
- Ⓟ 4PCS
- Ⓜ 1PC

Attach the bed leg (16) to the headboard (1) and footboard (2) with screws (P), then attach the Angle iron (6) to the footboard (2) with the M8 bolt (B).

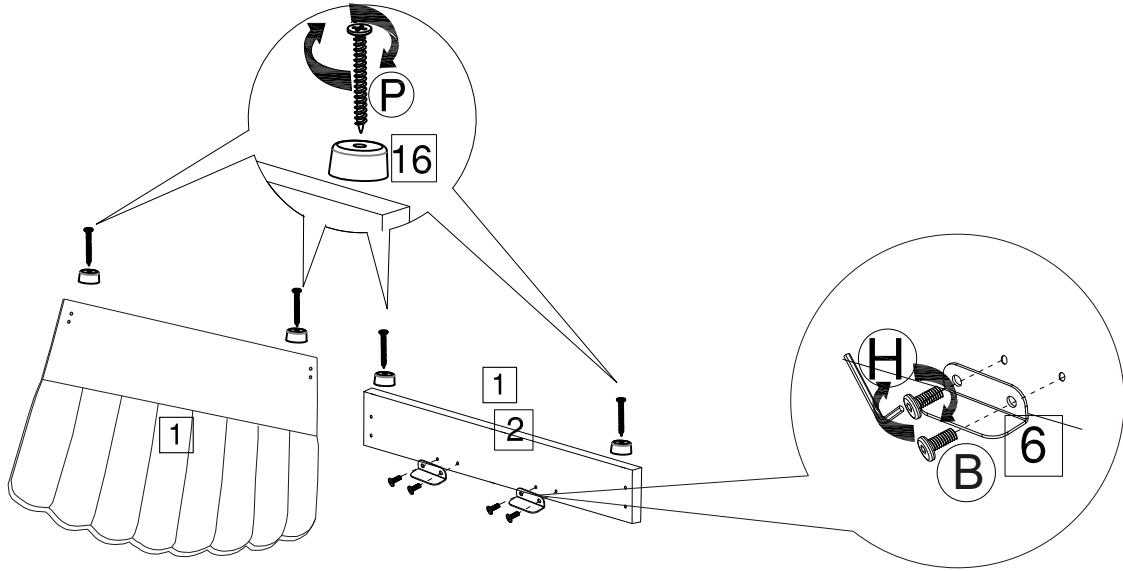

Step 2:

- Ⓞ 4PCS
- Ⓜ 8PCS
- Ⓞ 8PCS
- Ⓜ 1PC
- Ⓞ 8PCS
- Ⓞ 8PCS
- Ⓜ 8PCS

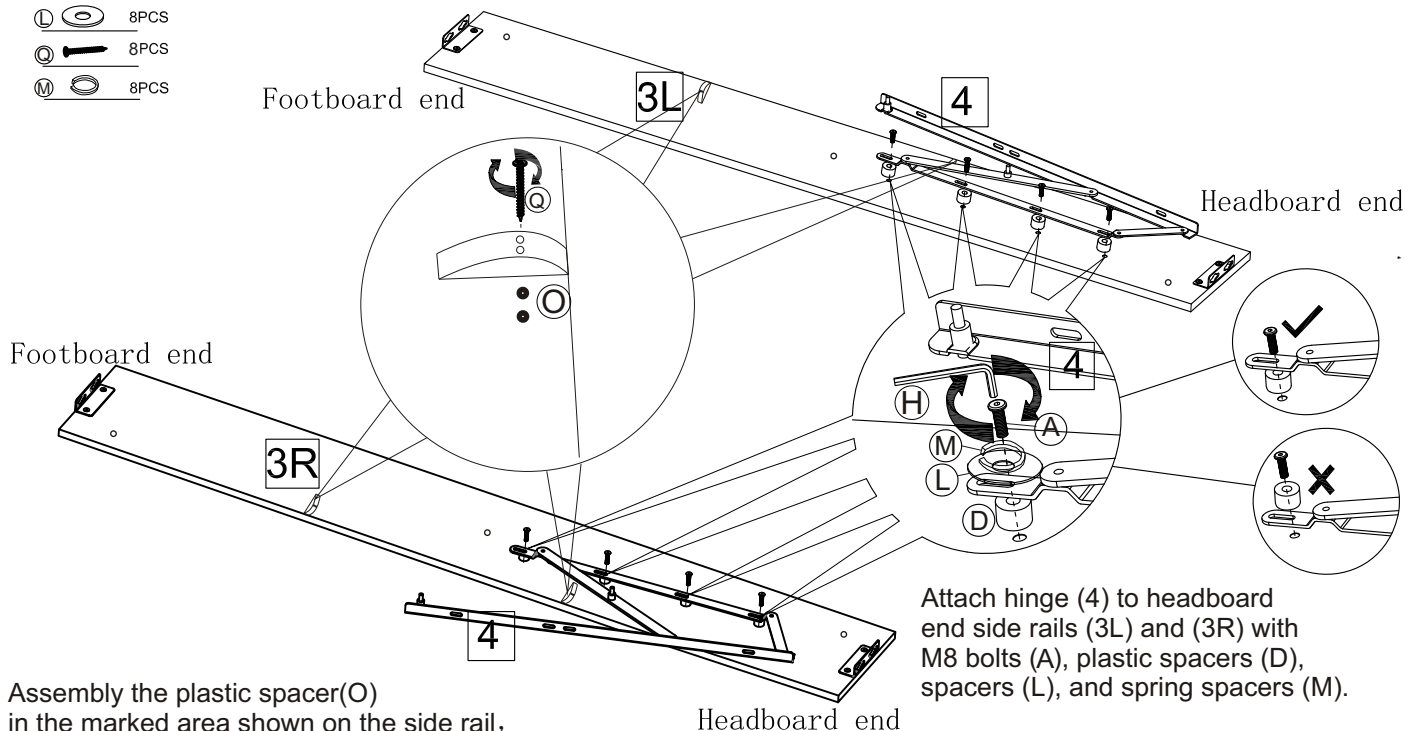

Assembly the plastic spacer(O) in the marked area shown on the side rail, Make sure edge of part O are align with sideboard part 3.

Attach hinge (4) to headboard end side rails (3L) and (3R) with M8 bolts (A), plastic spacers (D), spacers (L), and spring spacers (M).

Step 3:

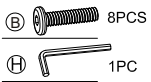

Attach side rail assembly (3L,3R)
to headboard (1) and footboard (2) with M8 Bolt (B).

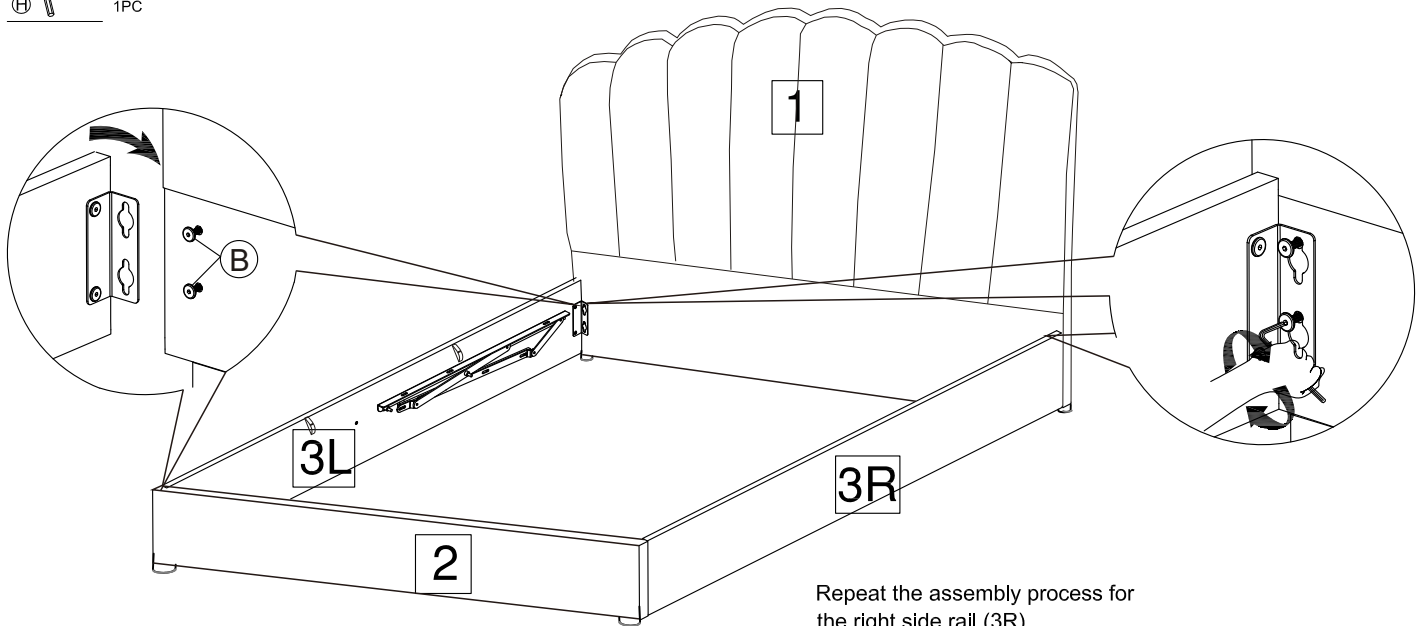

Ensure that the entire bed frame
assembly is a regular rectangle
as shown below.

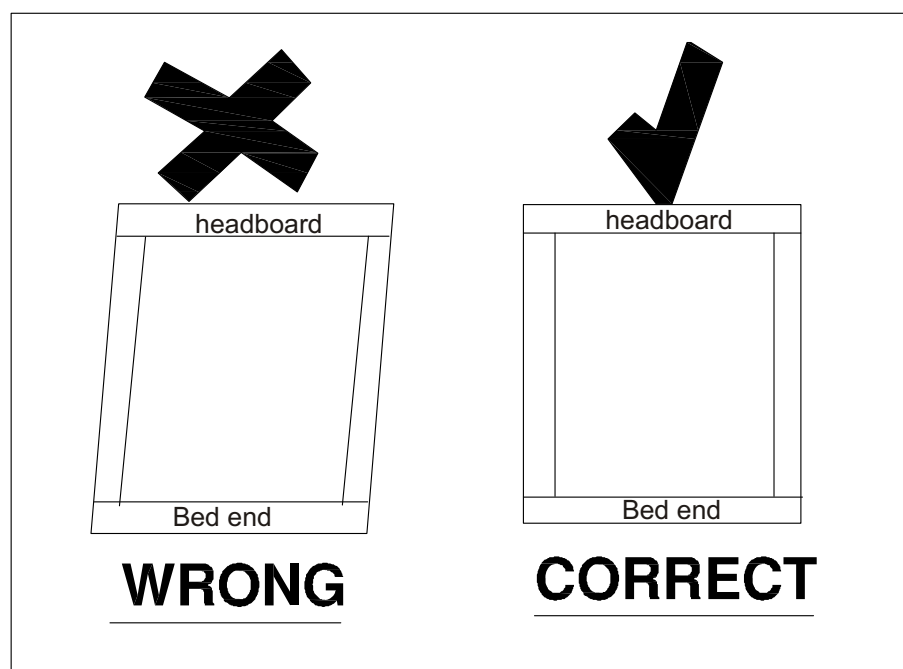

* gas lift mechanism will be affected if the bed frame is out of shape.

Step 4:

(E)  10 PCS



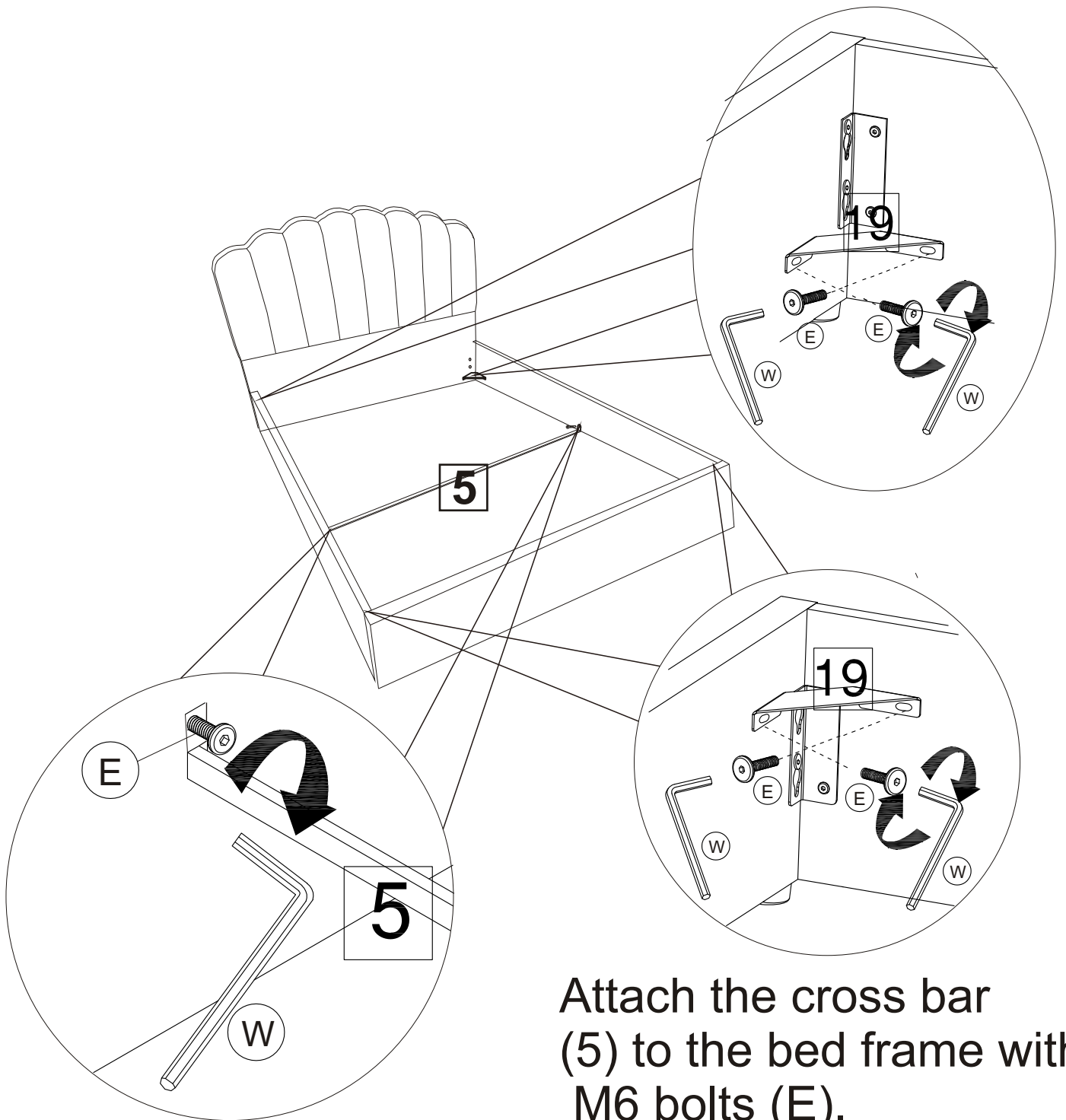

(W)  1 PC

Connect metal corner bracket (19) to side rail and Footboard&Headboard with M6 bolts (E).



Attach the cross bar (5) to the bed frame with M6 bolts (E).

Step 5:

- (A)  8PCS
- (F)  8PCS
- (G)  1PC
- (H)  1PC
- (C)  4PCS

The bottom view ensures that the holes in the dashed box are aligned.



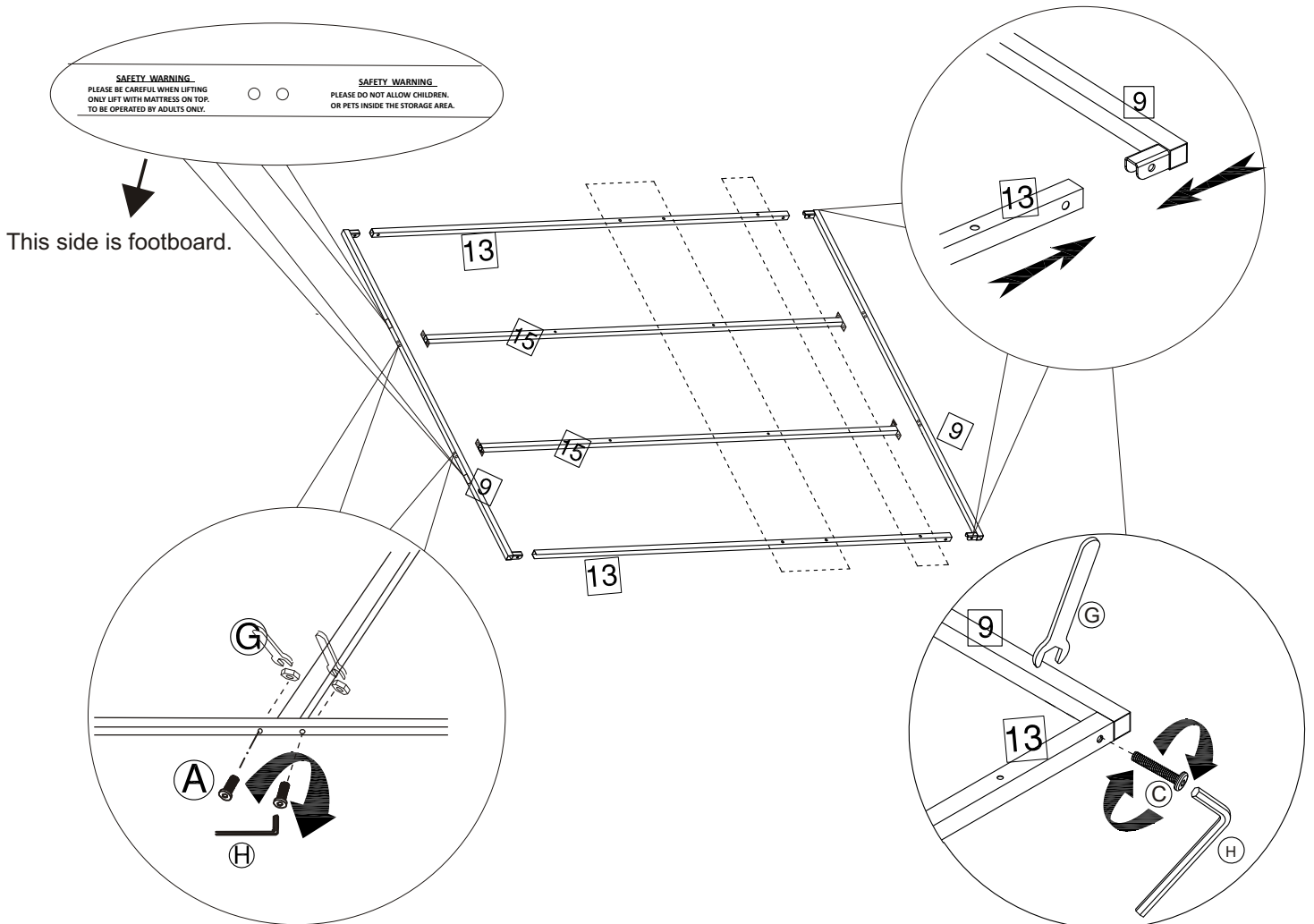

Ensure that the holes are aligned when joining 13 and 9.



Assemble the interior framework (15 and 9) as shown with M8 bolts (A).

Assemble the interior framework (13 and 9) as shown with M8 bolts (C).

Step 6:

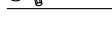

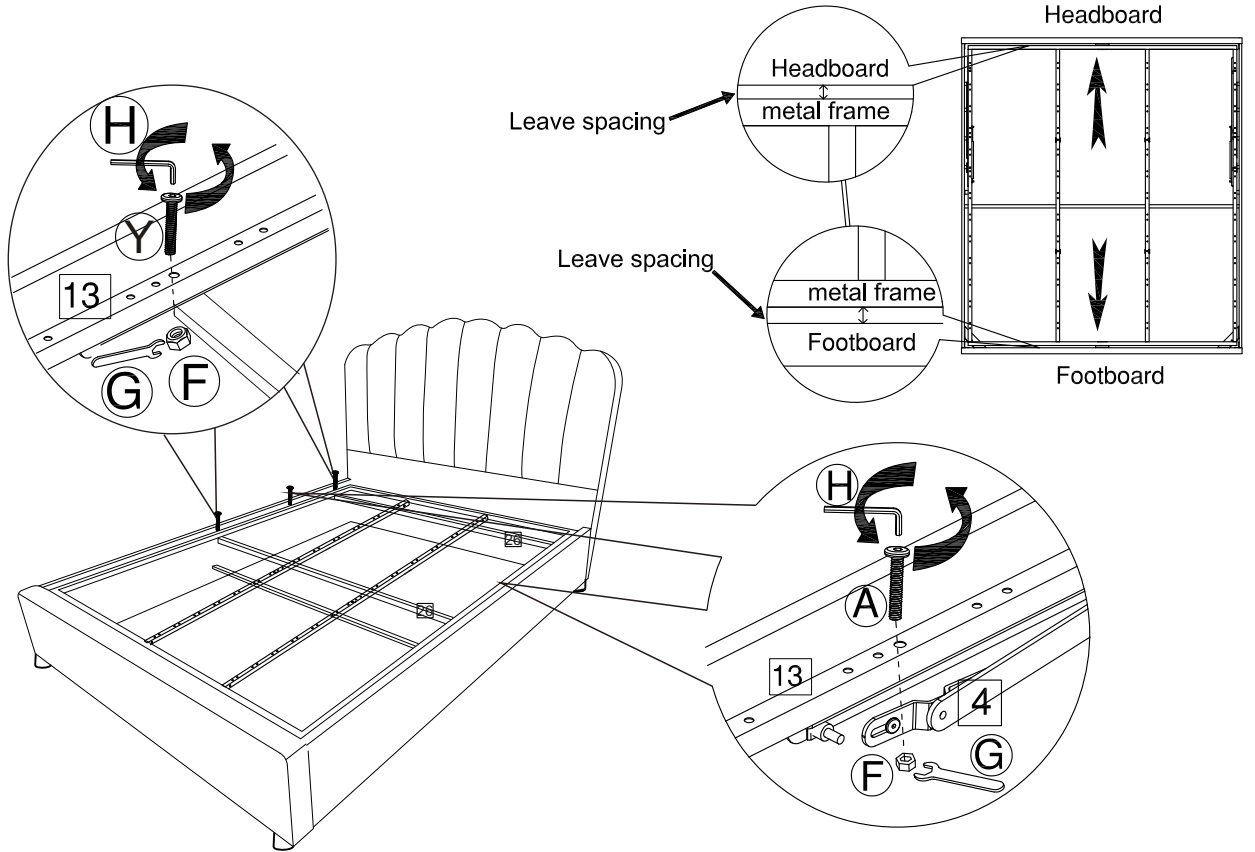

-  2 PCS
-  4 PCS
-  6 PCS
-  1 PC
-  1 PC



Attach the connect bar (26) to the side pipe (13) with M8 bolts (Y) and M8 nuts (F) as shown.

First, use the M8 bolts (A) and M8 nuts (F) to connect the side pipe (13) to the hinge (4). At this stage, do not fully tighten the M8 bolts (A) to allow for some adjustment between the headboard, footboard and metal frames. There should be some spacing between the headboard, footboard and the metal frames. Once every part is aligned, fully tighten all M8 bolts (A).

Step 7:

-  4 PCS
-  4 PCS
-  1 PC
-  1 PC

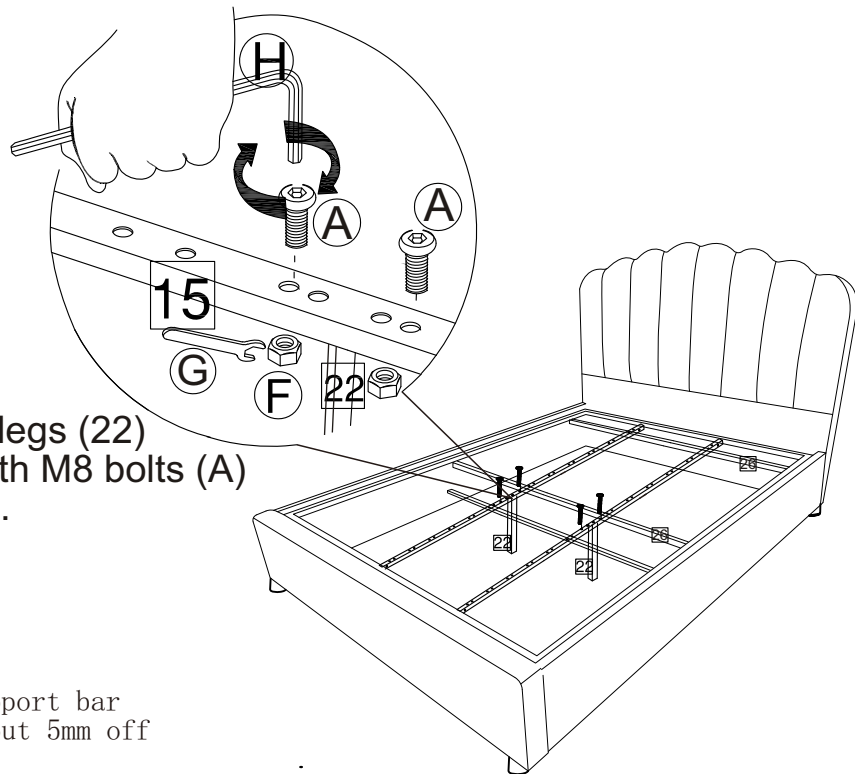

Attach the centre support legs (22) to the central pipe (15) with M8 bolts (A) and M8 nuts (F) as shown.

ATTENTION

When attached to central support bar, the support legs will be about 5mm off the floor. This is not a flaw. When weight is placed on the bed frame, the supports will consequently come into contact with the floor.

Step 8:

10  1PC

Tie the rope (10) to the interior frame at the central pipe as shown.

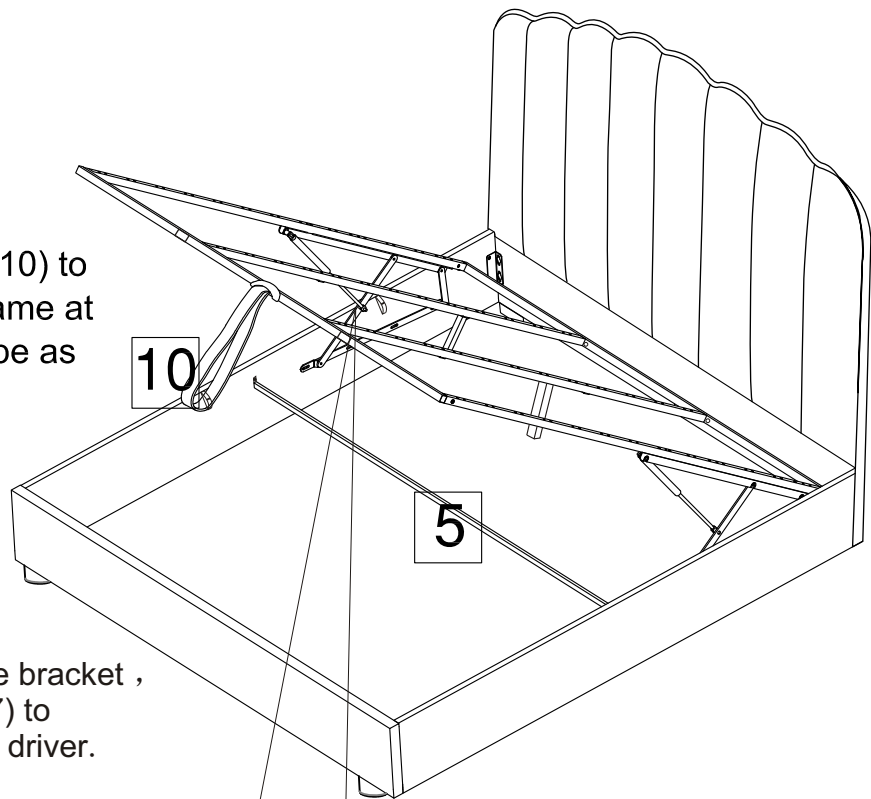

Loosen the screw on the bracket , then attach the piston (7) to the hinge (4) with screw driver.

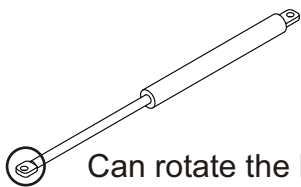

Can rotate the bronze hook to fix screw

7 Gas Strut 2pcs

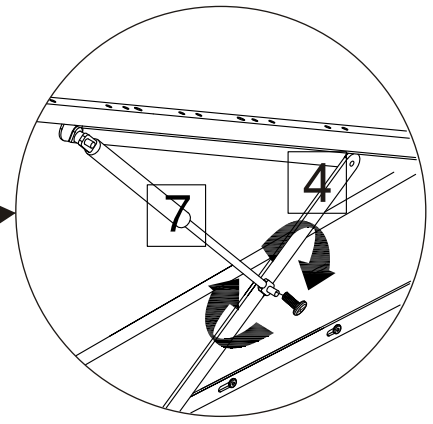
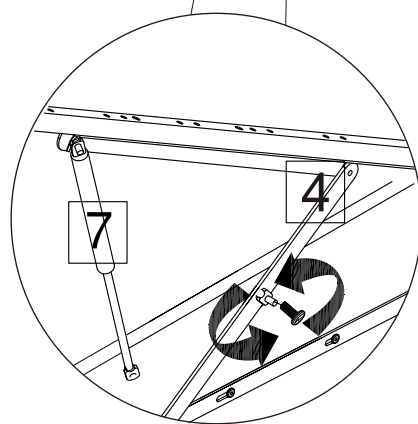

LIFTING THE BED FRAME

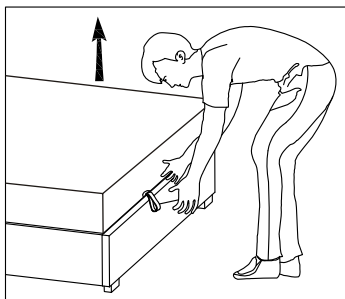

Pull the rope with both hands to lift the bed frame.

Please have your mattress on the bed frame which will help you easily pull and press the metal base.

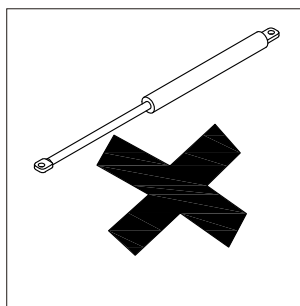

Do not test gas struts by hands, please have them assembled to the metal frame then pull and press the metal base.

LOWERING THE BED FRAME

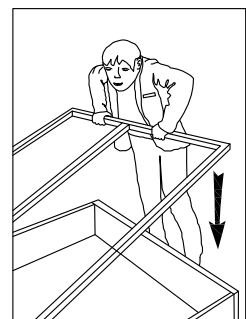

To lower the bed frame, press it down with both hands as shown.

Step 9:

8 26PCS

14 26PCS

Attach the plastic slat caps (8)
to each slat (11) at the side.
Then press down the caps into
the corresponding holes on the
side pipes (13) as shown.

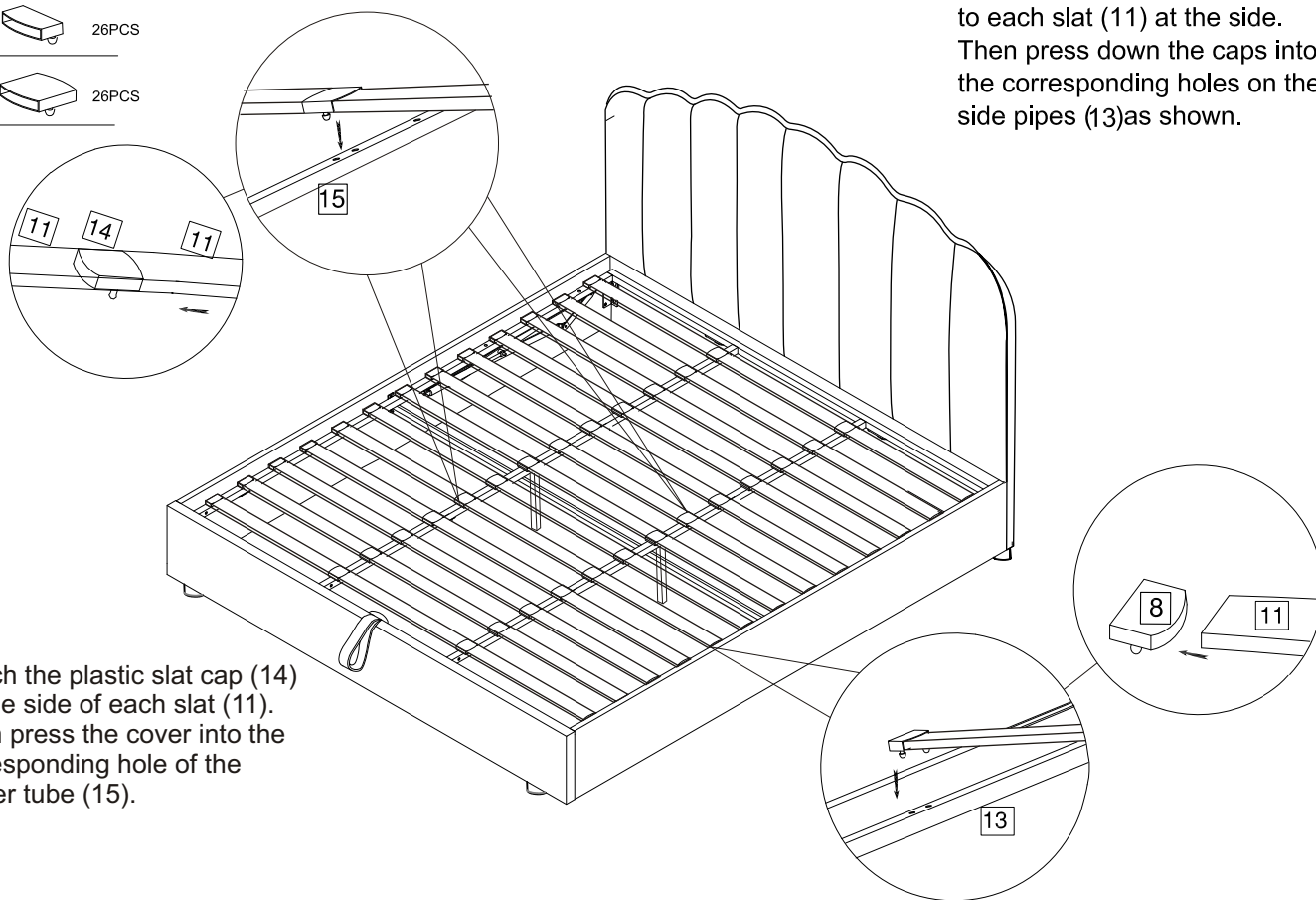

Attach the plastic slat cap (14)
to the side of each slat (11).
Then press the cover into the
corresponding hole of the
center tube (15).