









DINING CHAIR

MODEL: DCH-SURA

ASSEMBLY INSTRUCTIONS

A		1pc
B		1pc
C		1pc
D		8pcs
E	 M6x20	8pcs
F	 M6x16	8pcs
G	 M5	1pc
H		1pc

WARNING

- Do not stand on the chair or use it as stepping stool.
- Do not use this product until all screws are securely fastened.
- Do not use any sharp tool to open any packaging.

- ## ASSEMBLY TIPS
- Do not fully tighten the screws until all of them are aligned properly with the holes.
 - If the legs are uneven on the ground during assembly, loosen some screws and add some pressure on the chair to ensure the legs are even. Then tighten the screws diagonally.

ASSEMBLY STEPS

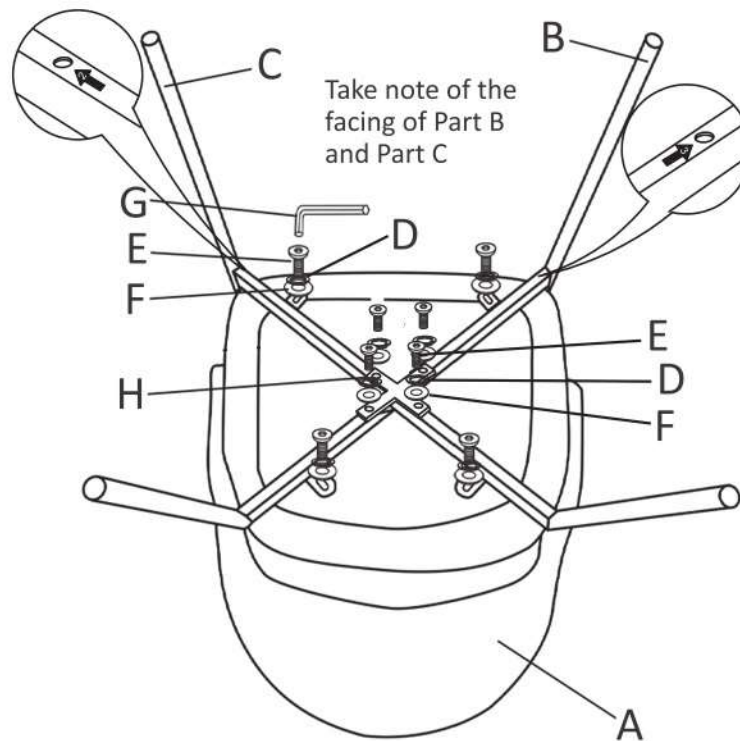

COMPLETED ASSEMBLY

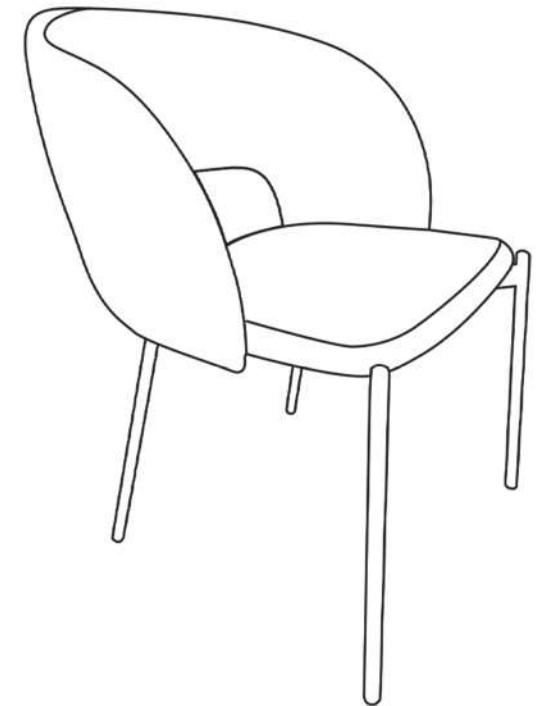

DINING TABLE
MODEL:DTB-RONI

ASSEMBLY INSTRUCTIONS

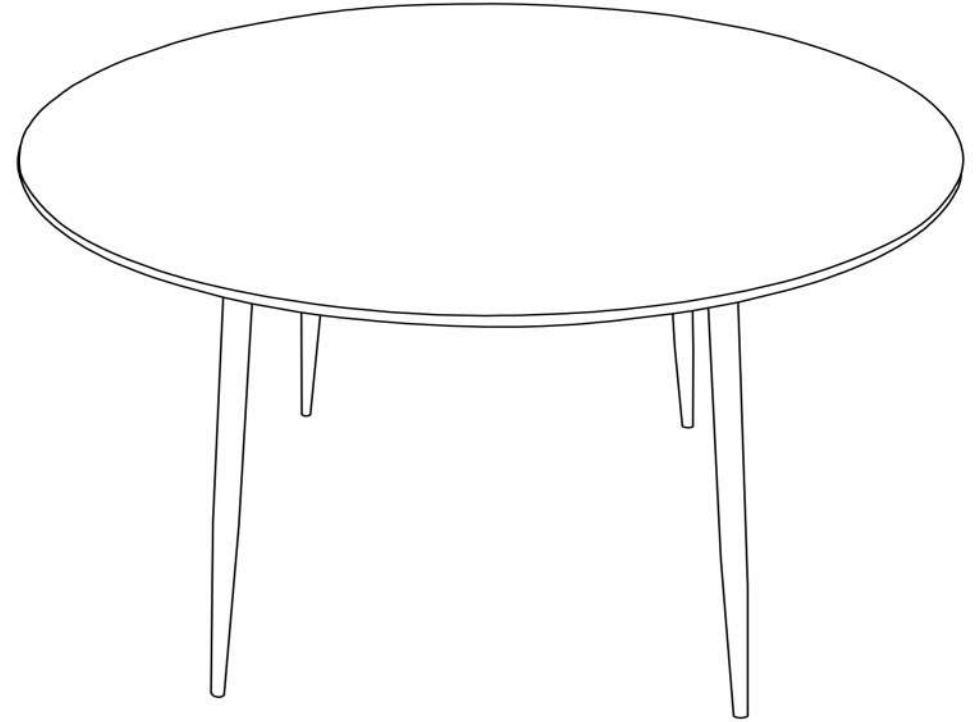
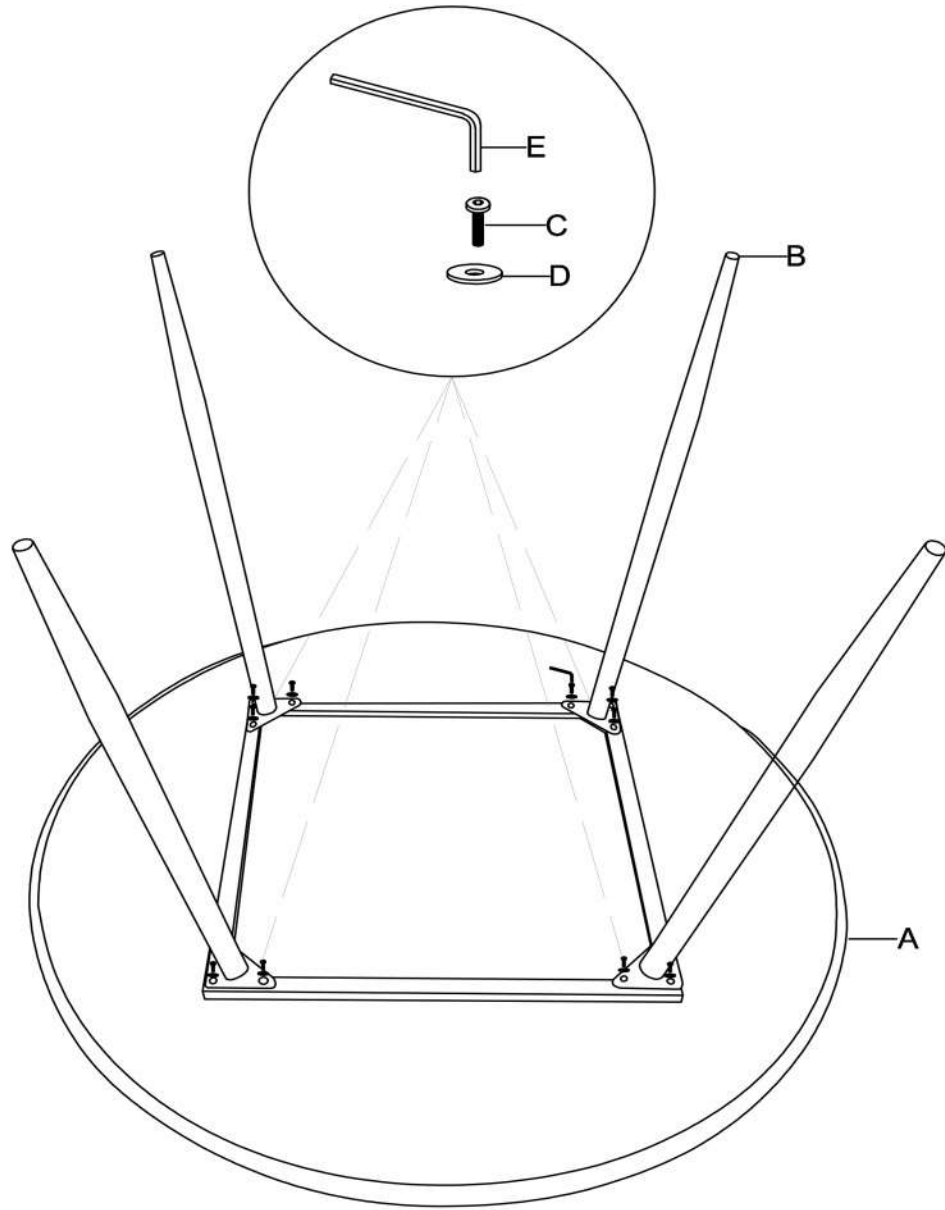

A	B	C	D	E
1	4	M8 X 16 12	M8 X 18 12	M5 1