



ASSEMBLY DIAGRAM

EDDI BED

HB-EDDI



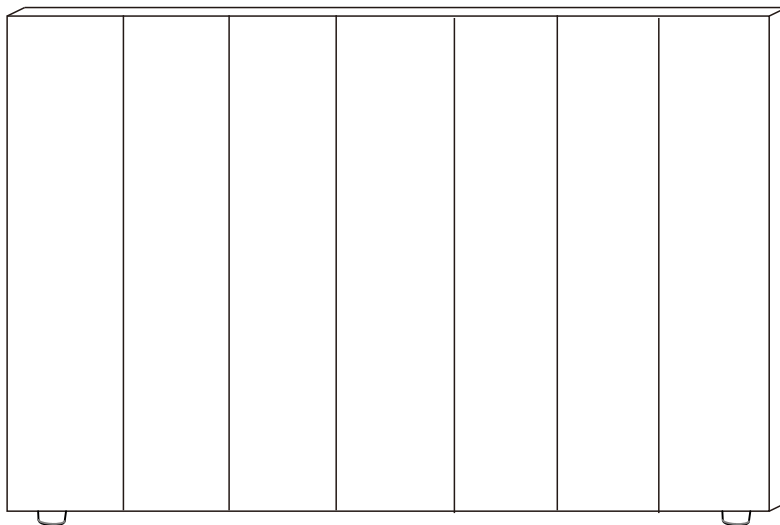

IMPORTANT NOTE:

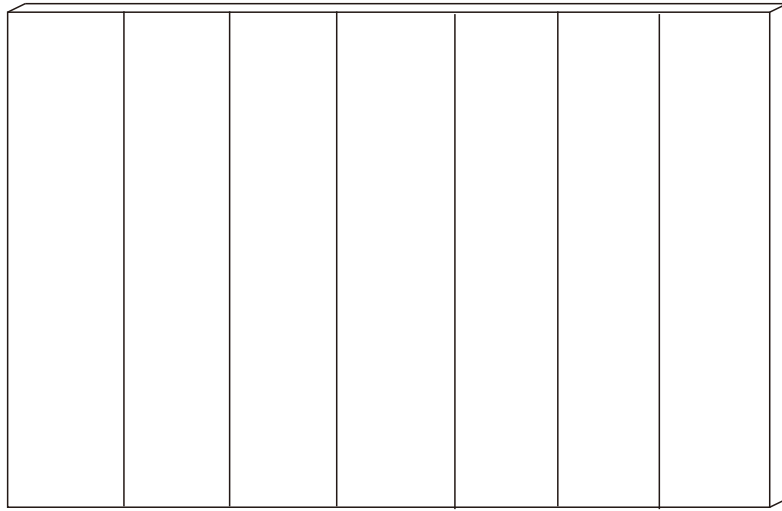
- * PLACE ALL PARTS ON A CLEAN AND SMOOTH SURFACE SUCH AS A RUG OR CARPET TO AVOID THE PARTS FROM BEING SCRATCHED.
- * KINDLY FOLLOW THE ASSEMBLY INSTRUCTIONS STEP BY STEP.
- * DO NOT TIGHTEN ALL SCREWS UNTIL THE BED IS FULLY SET-UP.





Fittings

A  4.0x50mm Screw 2pcs	B  Leg 2pcs	C  Bolts (M8x30mm) 2pcs	D  M6 Allen Key 1pc	E  metal plate 2pcs
-------------------------------------------------------------------------------------------------------------------	--------------------------------------------------------------------------------------------------------	--------------------------------------------------------------------------------------------------------------------	------------------------------------------------------------------------------------------------------------------	------------------------------------------------------------------------------------------------------------------



Please refer to the instruction words before installing it.

Step 1

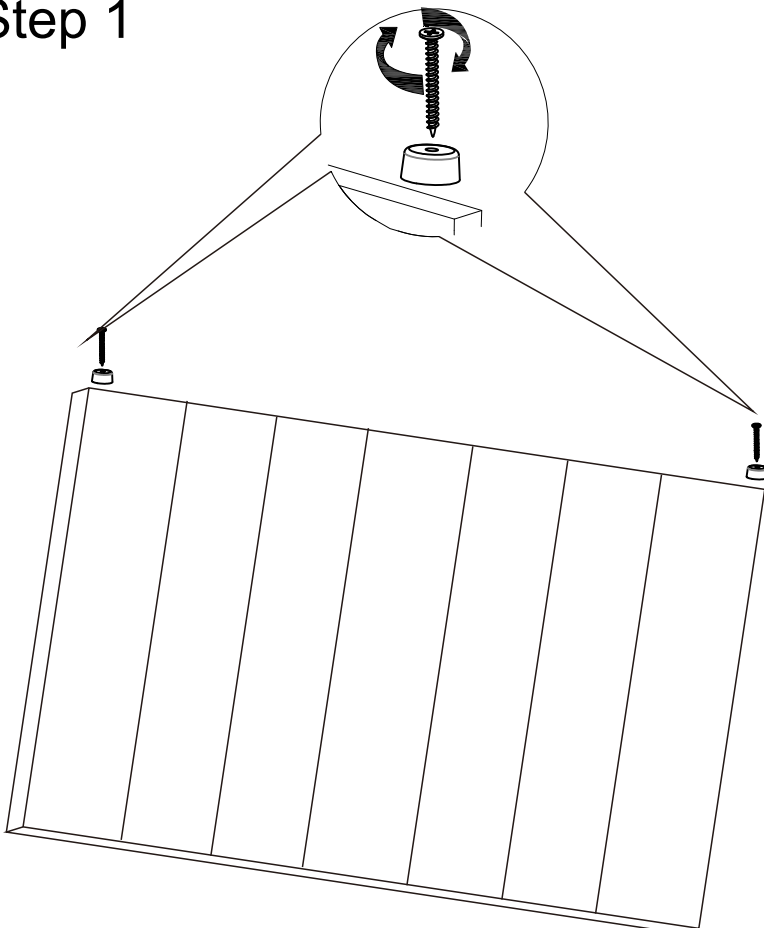
To fix the legs B to the headboard with screw A.



Step 2

<p>C  Bolts (M8x30mm) 2pcs</p>	<p>D  M6 Allen Key 1pc</p>	<p>E  metal plate 2pcs</p>
----------------------------------------------------------------------------------------------------------------------------	------------------------------------------------------------------------------------------------------------------------	------------------------------------------------------------------------------------------------------------------------

Connect the two headboards with C,D and E.

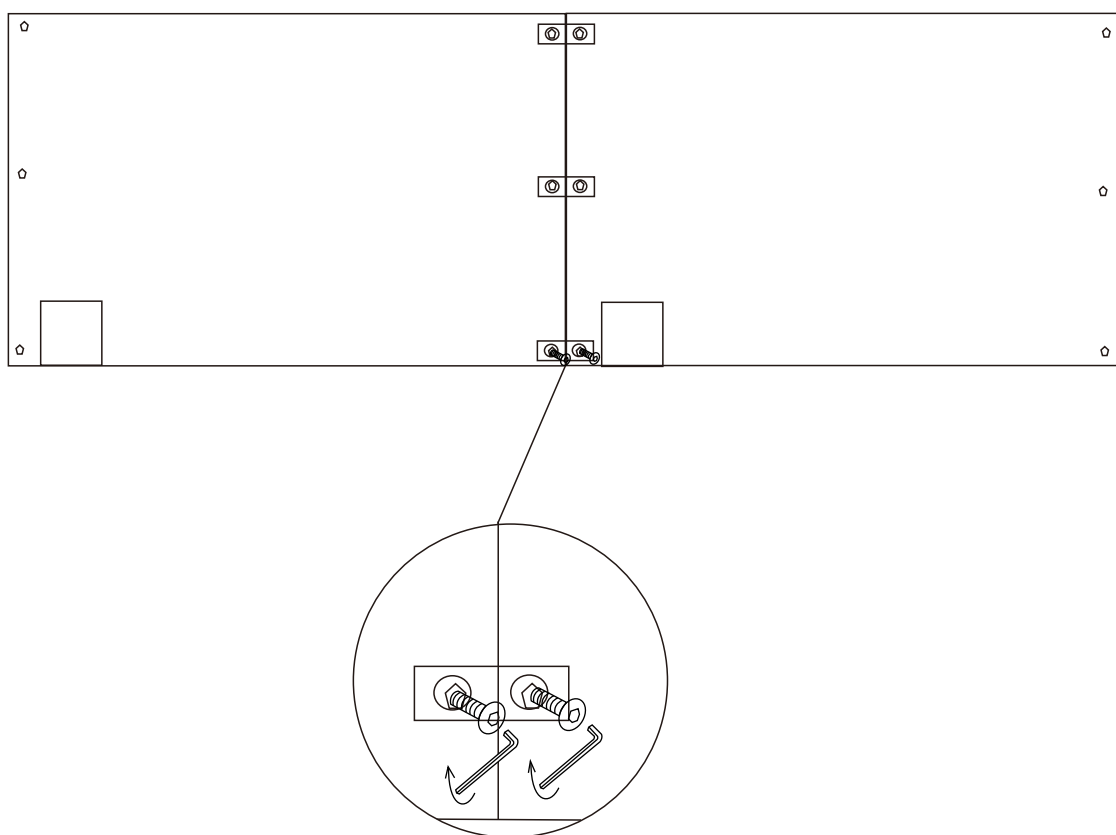

Remark: part C,D and E are only used for 2 pieces assembly.