

2

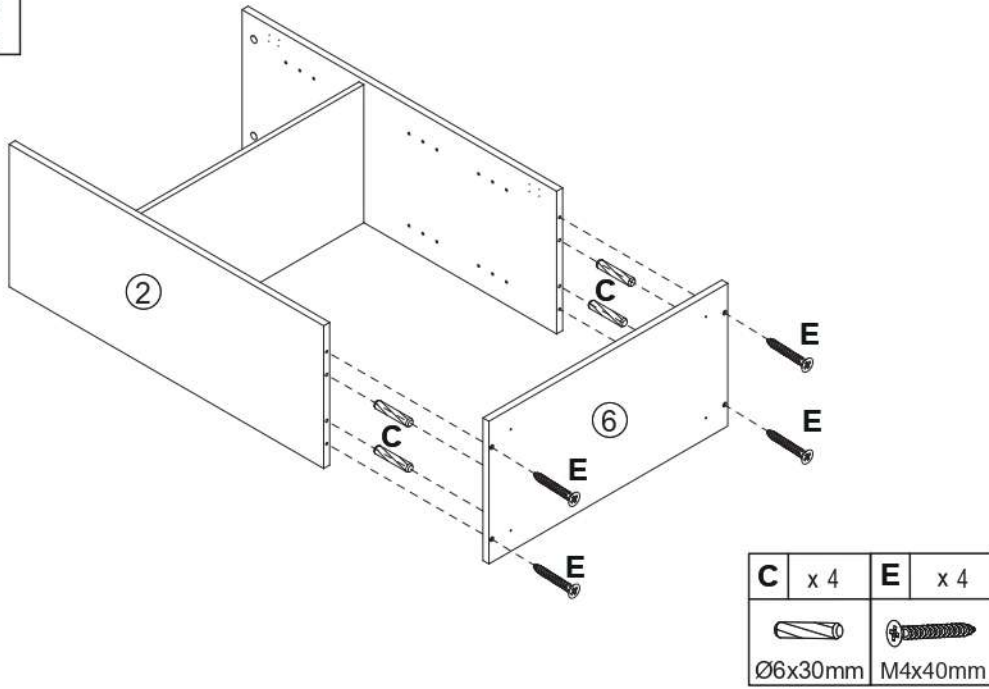

4

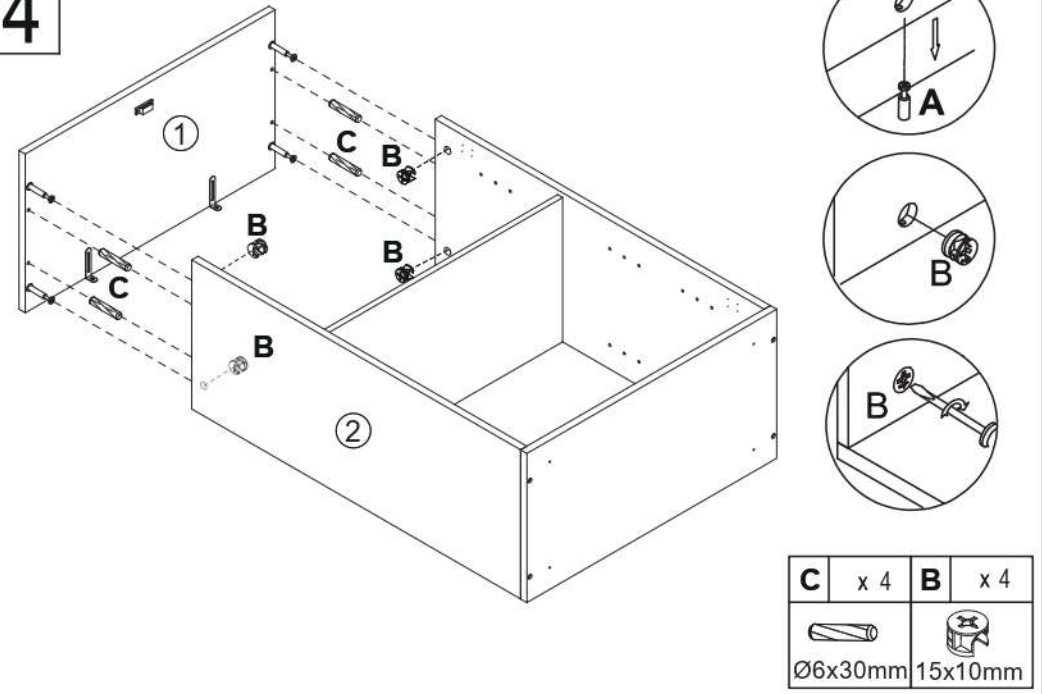

3

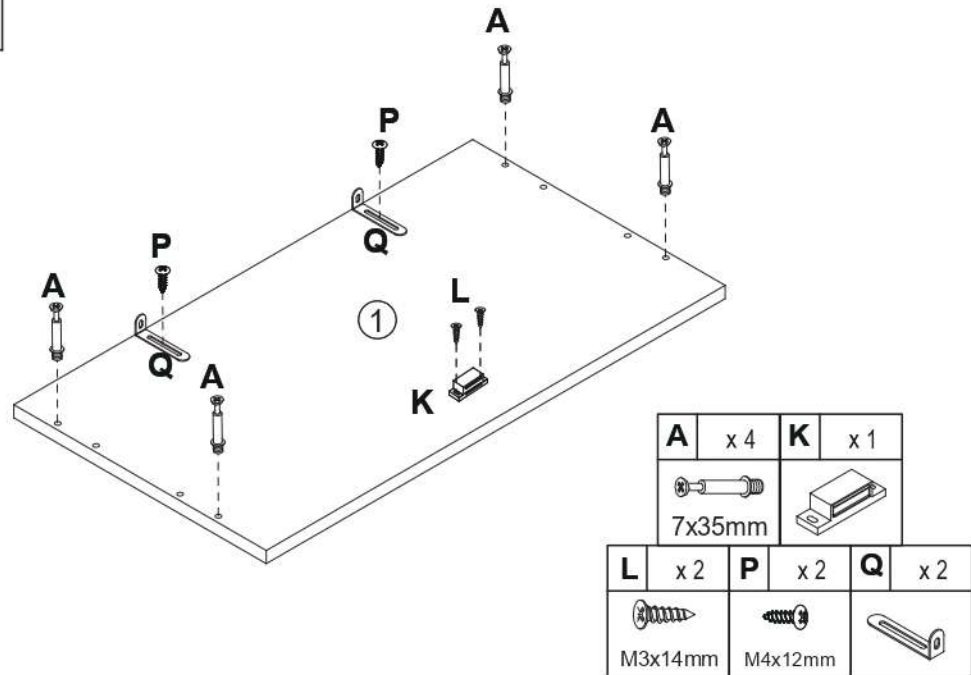

5

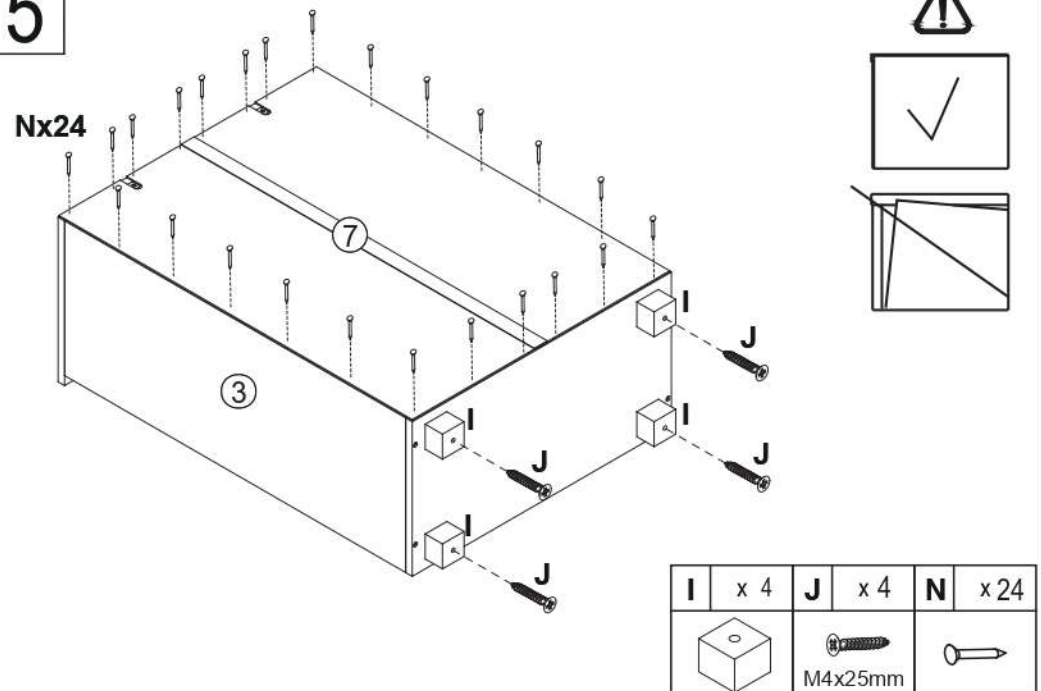

6

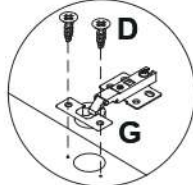
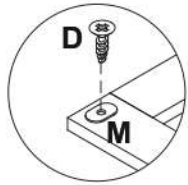
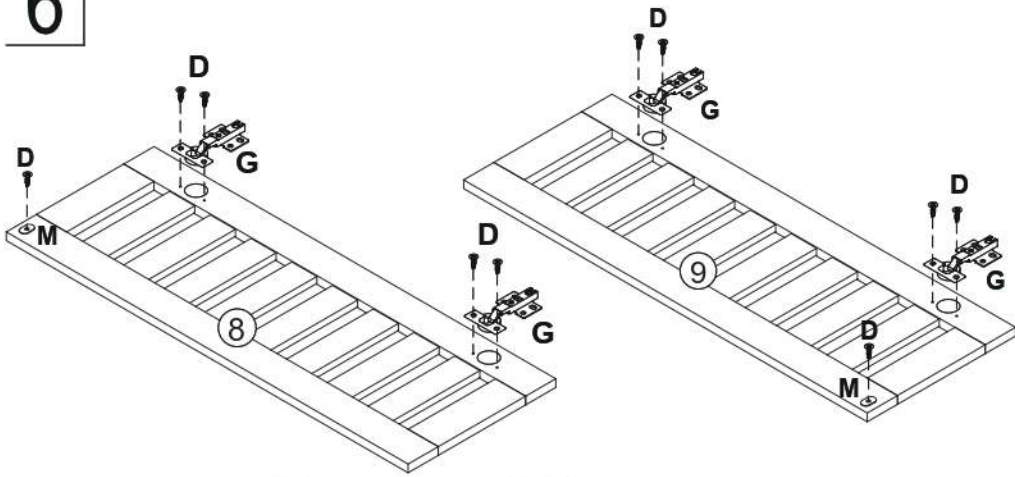

D	x 10	G	x 4	M	x 2
M3.5x12mm					

8

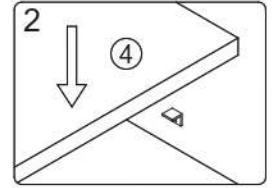
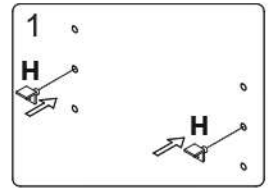
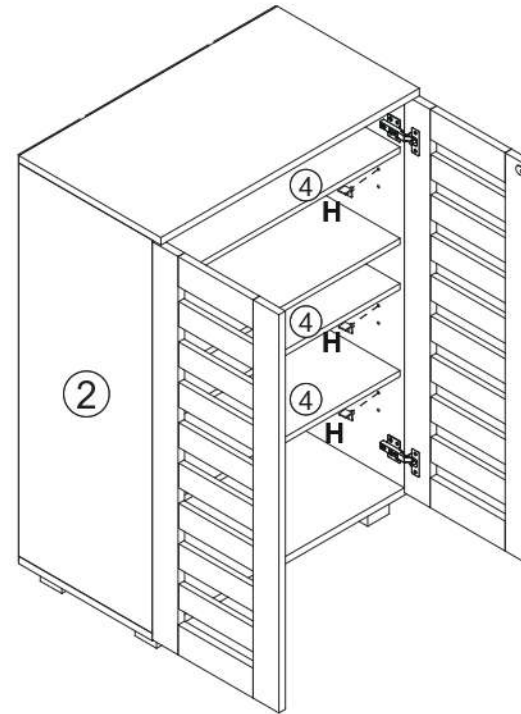

H	x 12

7

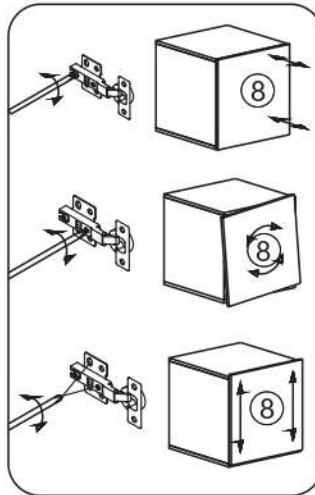
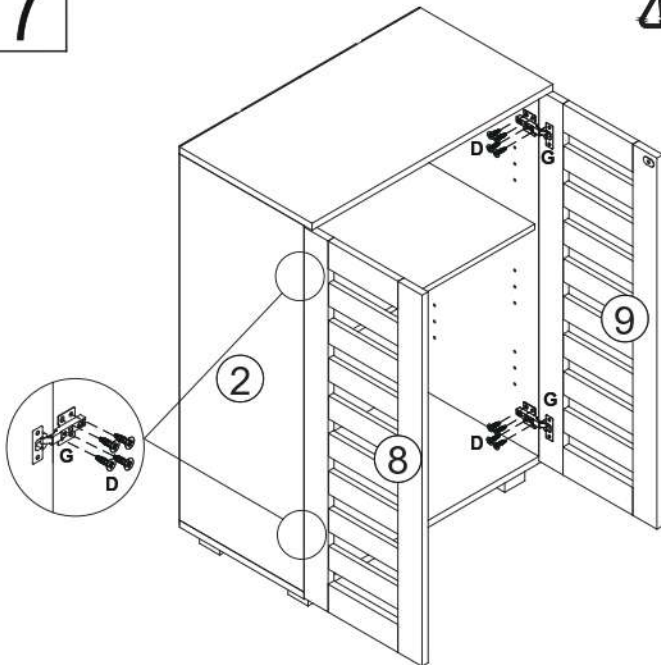

D	x 16
M3.5x12mm	

9

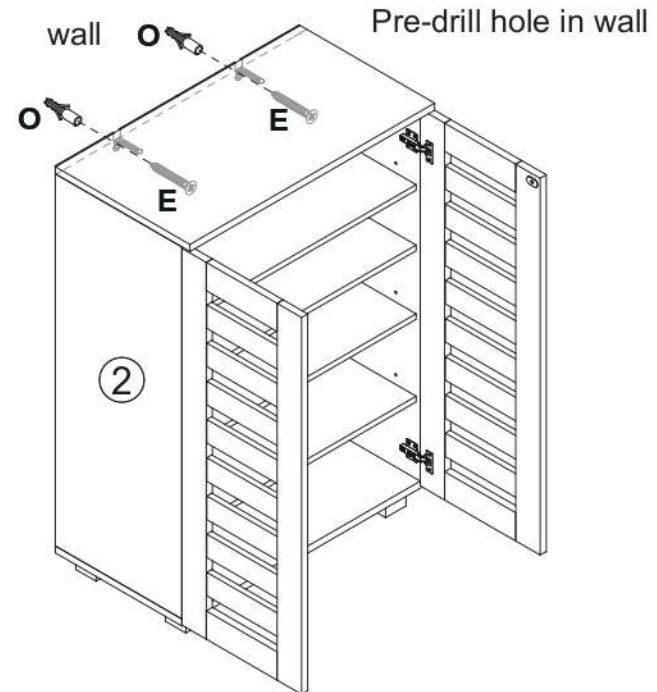

E	x 2	O	x 2
M4x40mm			

SHOE STORAGE CABINET

MODEL:SS-AND-D2-WH/WD/BK

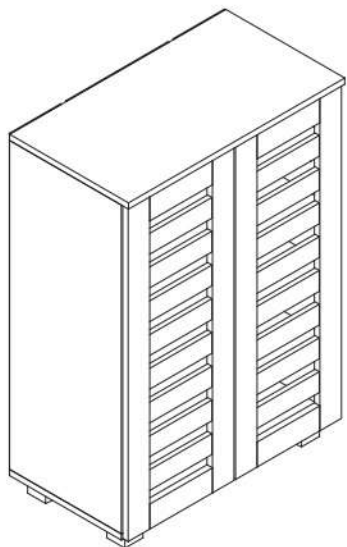















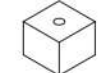

ASSEMBLY INSTRUCTIONS

Please read instructions carefully before assembly.



Two persons and tools required for assembly.

HARDWARE

A	4PCS	B	4PCS	C	12PCS	D	26PCS	E	10PCS	F	4PCS
											
7x35mm		15x10mm		Ø6x30mm		M3.5x12mm		M4x40mm			
G	4PCS	H	12PCS	I	4PCS	J	4PCS	K	1PC	L	2PCS
											
						M4x25mm				M3x14mm	
M	2PCS	N	24PCS	O	2PCS	P	2PCS	Q	2PCS		
											
						M4x12mm					

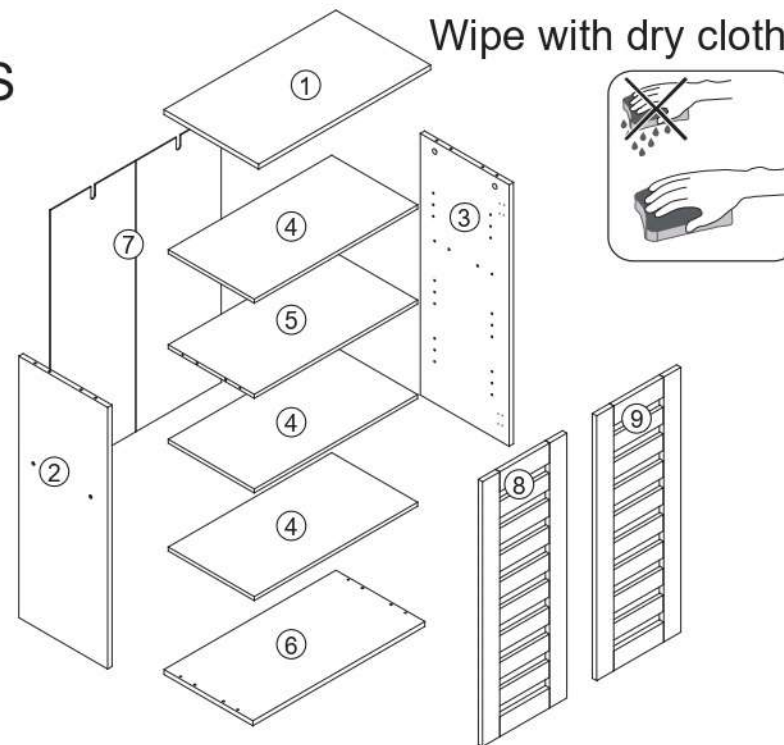

PARTS

Wipe with dry cloths

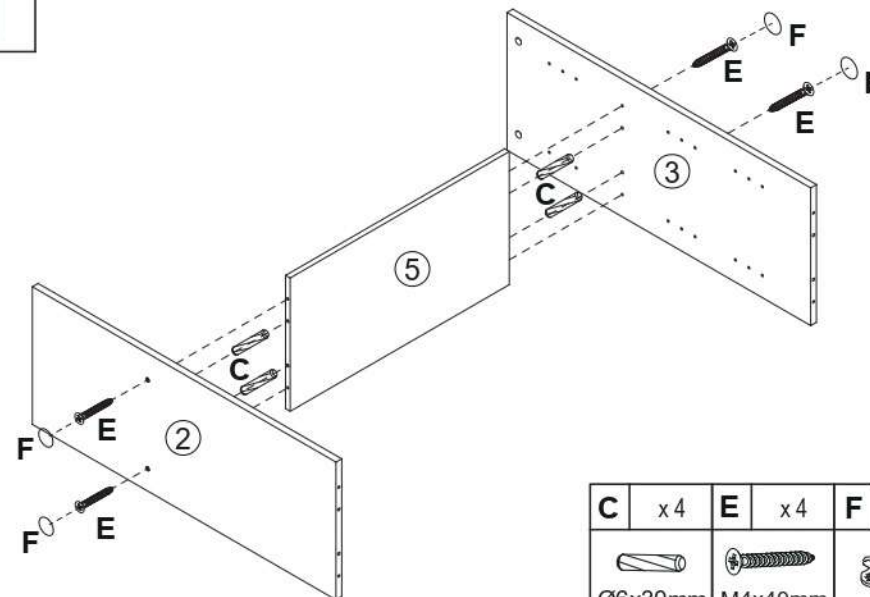

1



C	x4	E	x4	F	x4
					
Ø6x30mm		M4x40mm			