

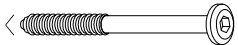

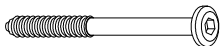



A		M6*100	8
B		M6*70	14
C			22
D		Φ8*30	24
E		Φ6*70	16
F		Φ6*100	2
G		4*30	28
H		4 mm	1

# STEP:1

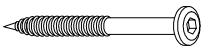
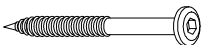

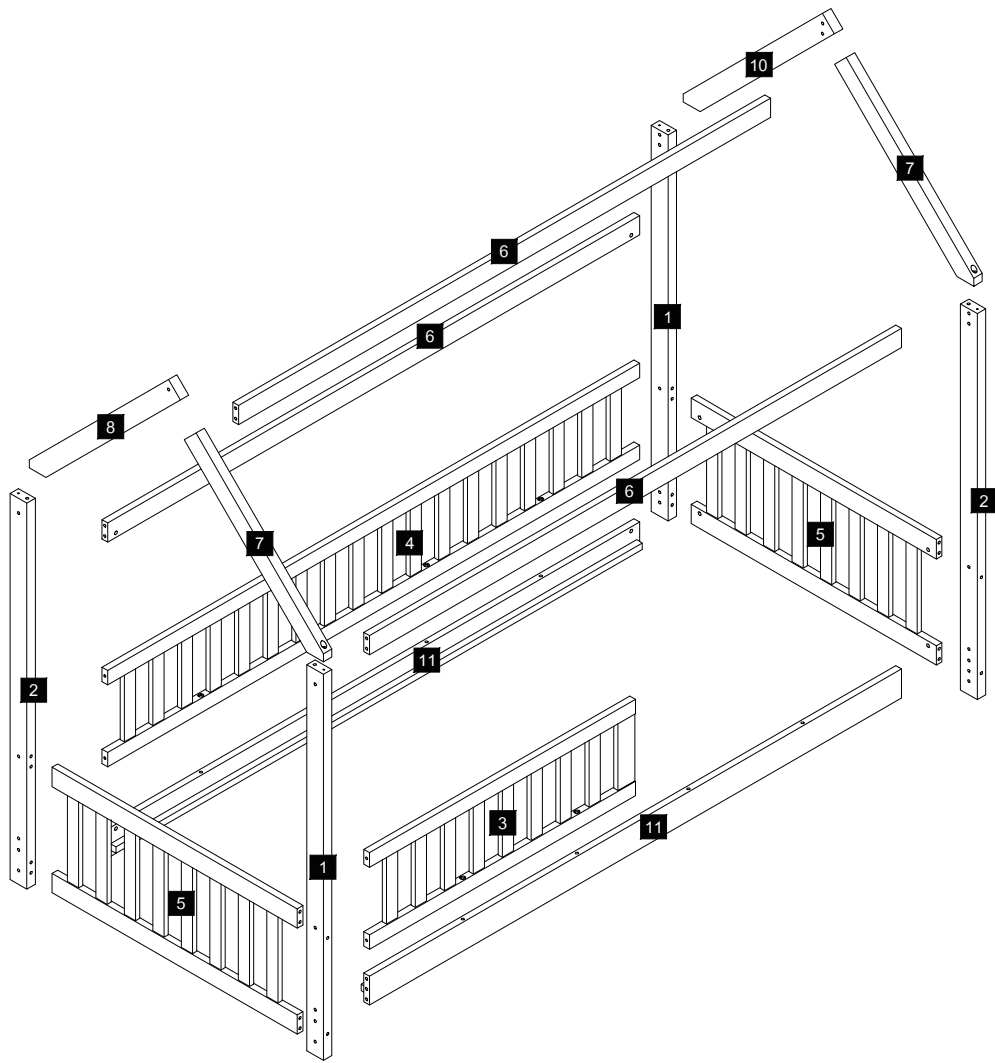
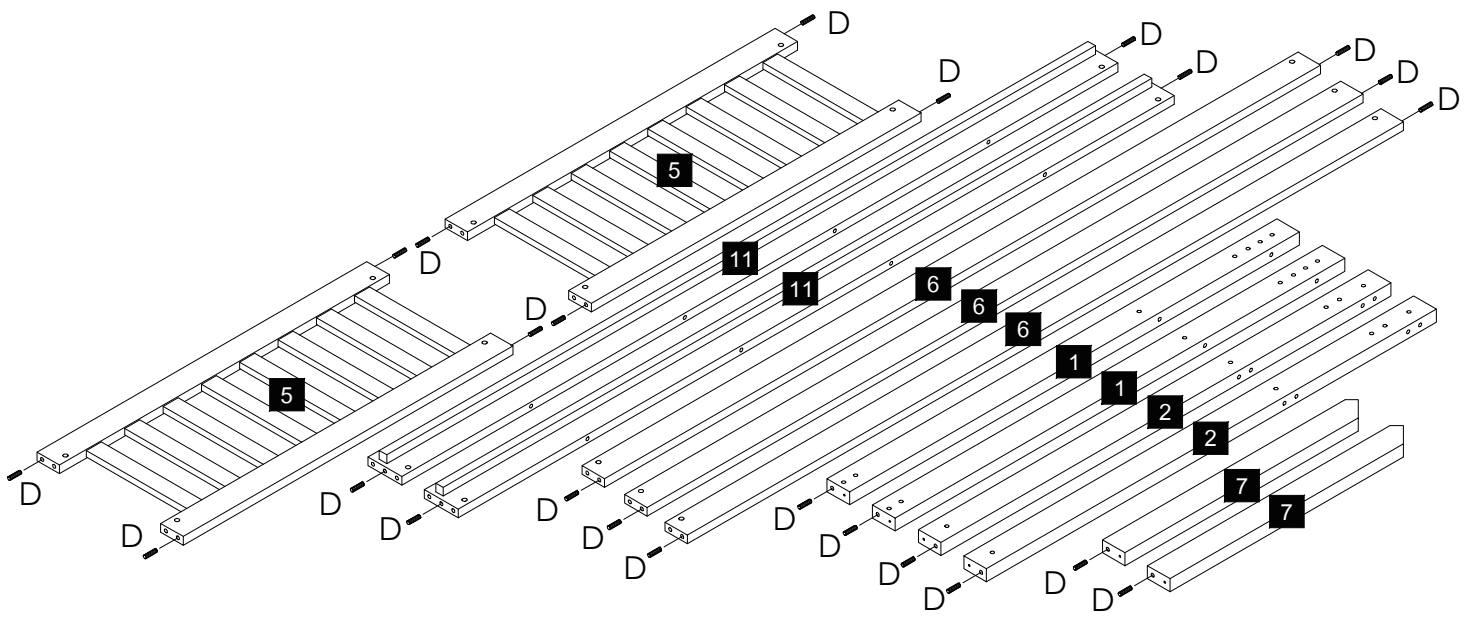

# STEP:2



D		Φ8*30	24
---	---	-------	----

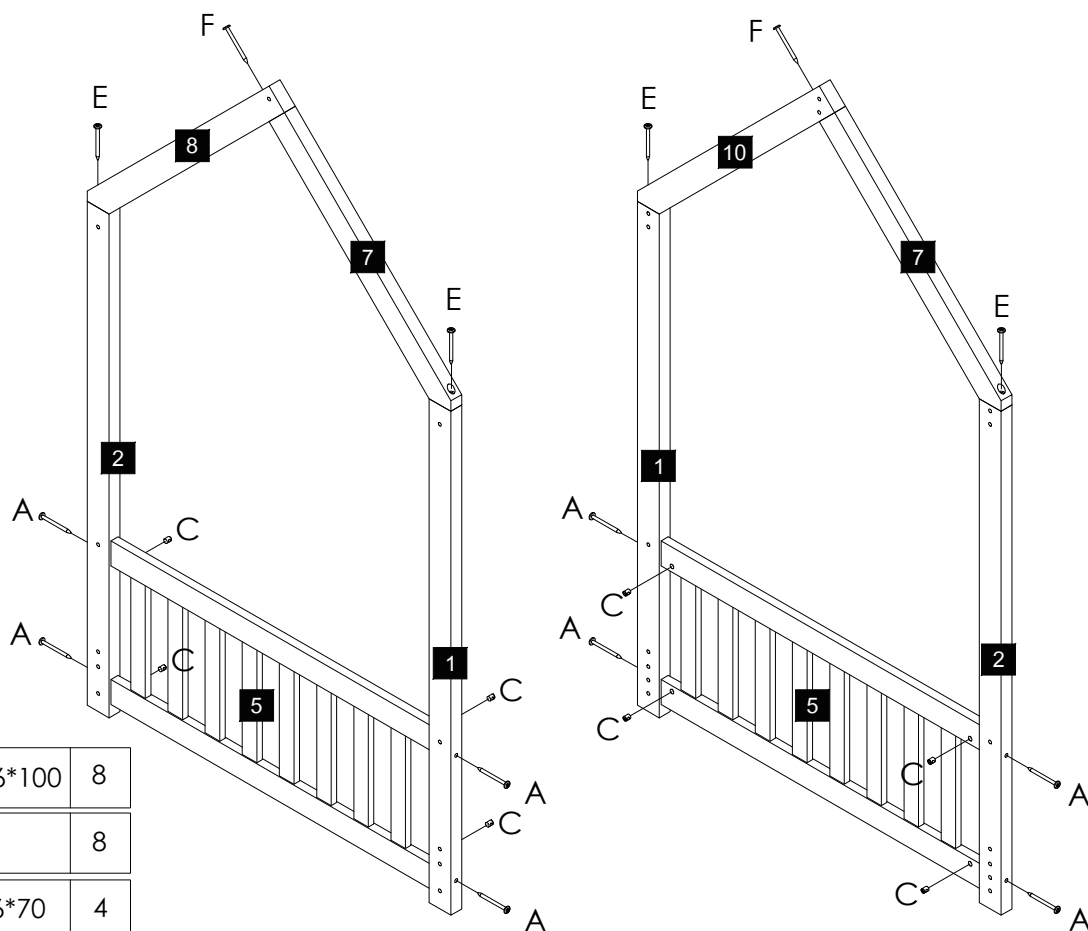

# STEP:3

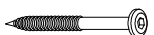
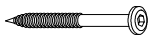

A		M6*100	8
C			8
E		Φ6*70	4
F		Φ6*100	2

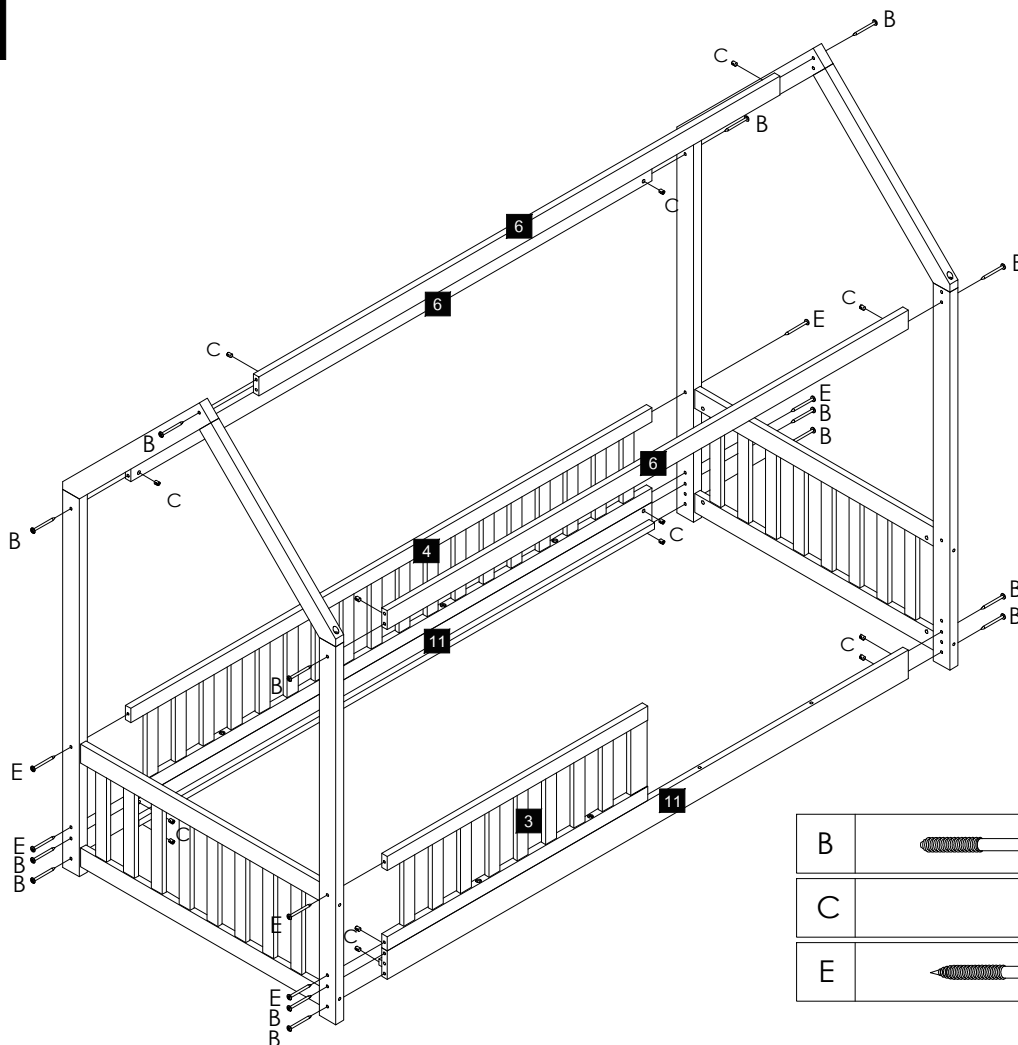
# STEP:4

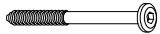

B		M6*70	14
C			14
E		Φ6*70	6

STEP:5

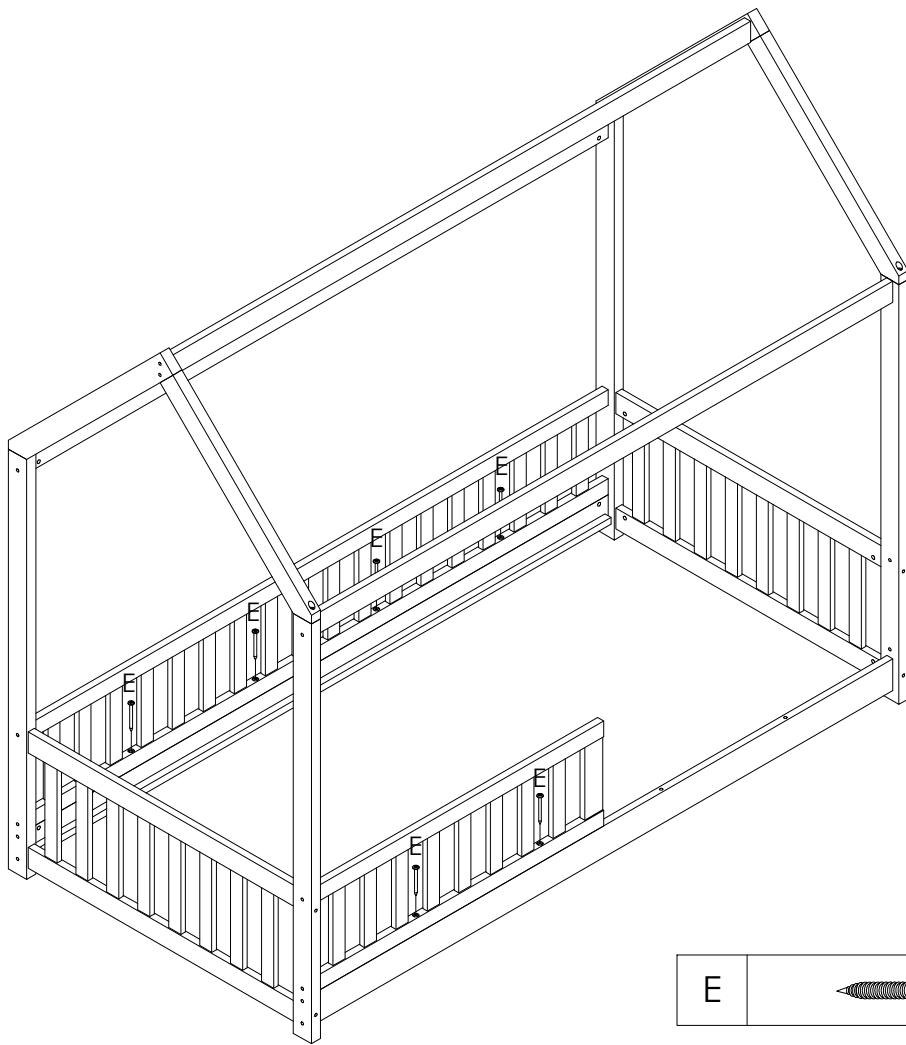

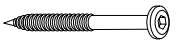
E		Φ6*70	6
---	---	-------	---

STEP:6

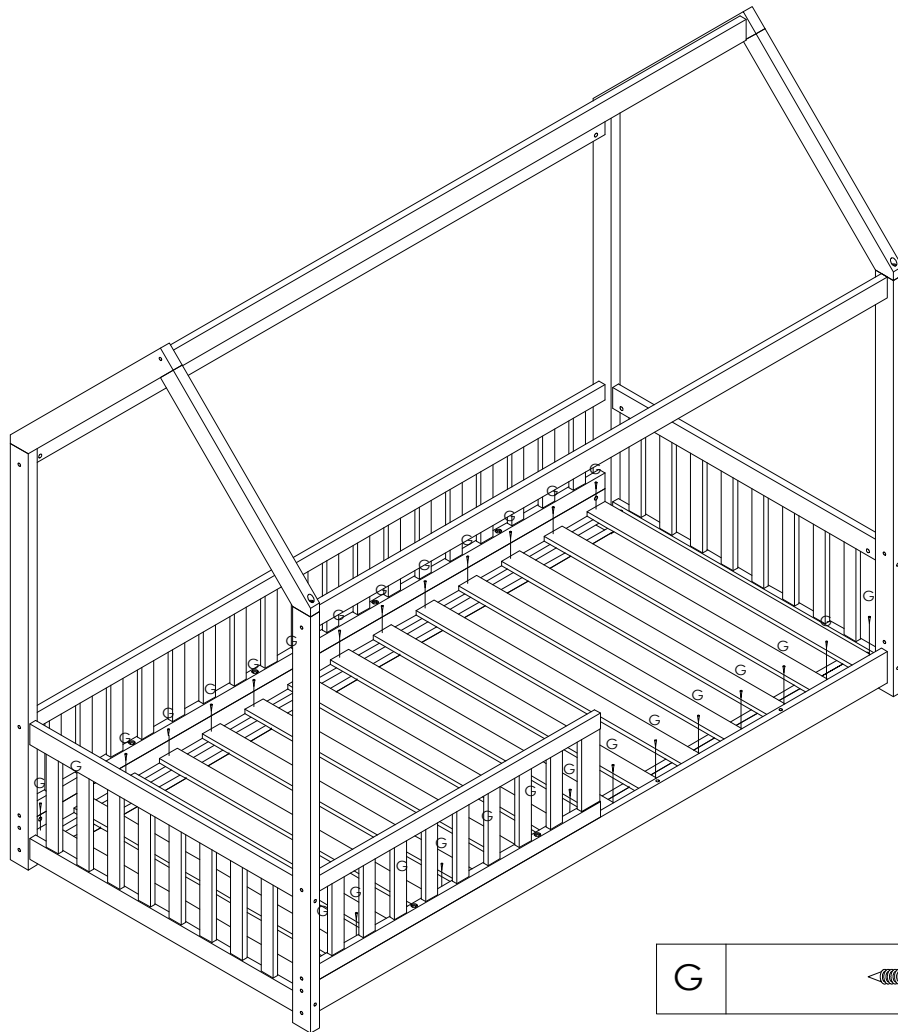

G		4*30	28
---	---	------	----