

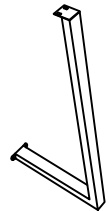

A		2PCS
B		1PCS
C		1PCS
D	 M6×15	12PCS
E		12PCS
F		1PCS

### Step 1

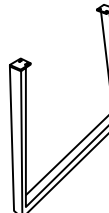
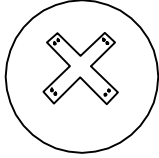
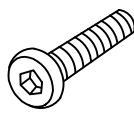

### Step 2

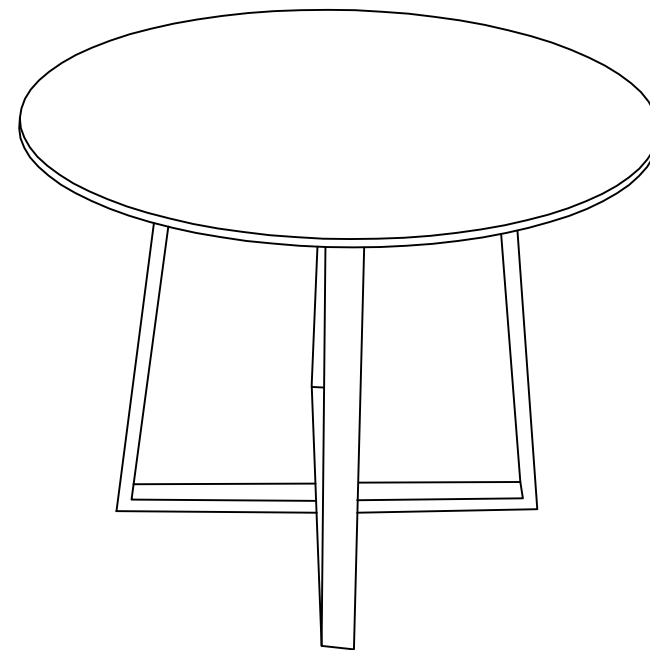
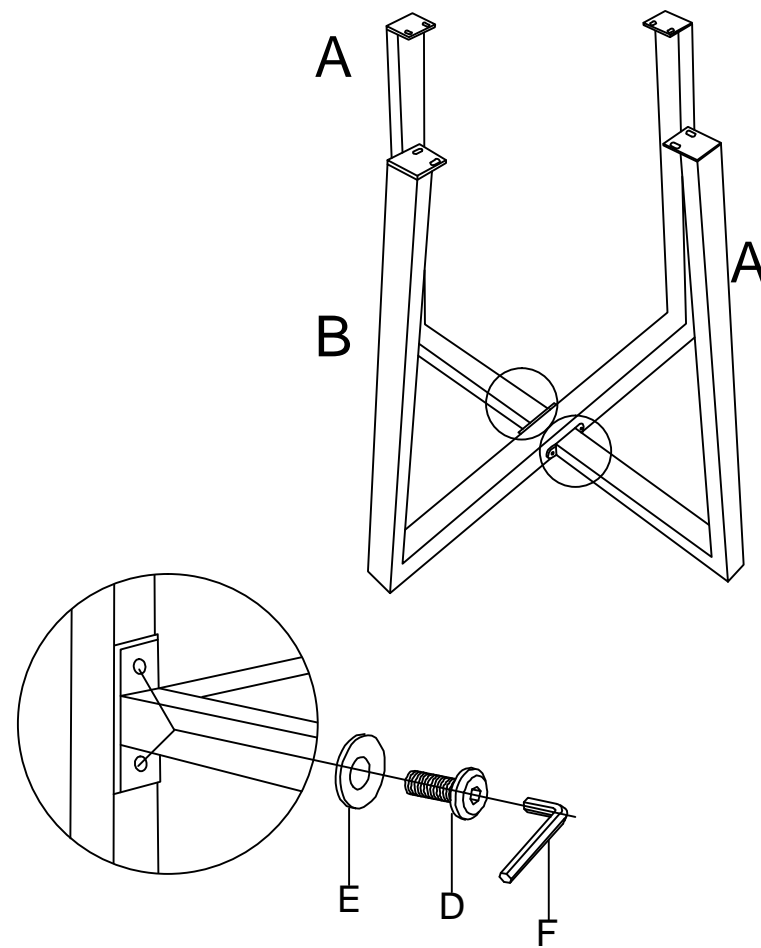