

Foldlux Ottoman Folding Bed

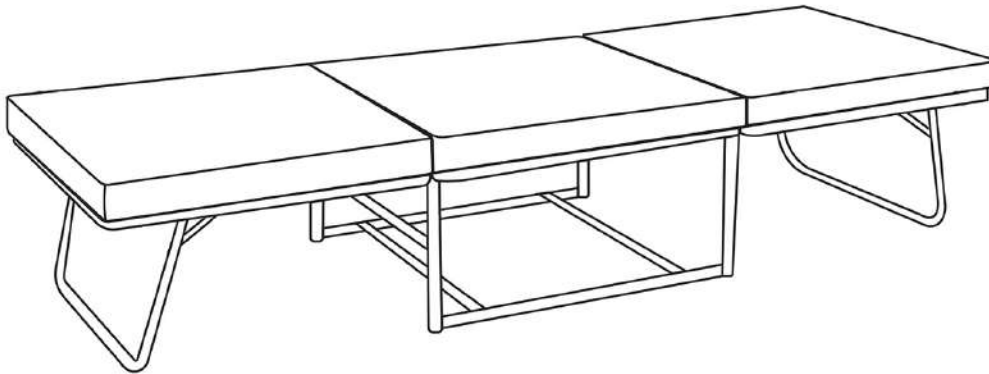

Thank you for choosing our product

- Please read this user manual carefully before using the product.
- Please keep this manual for future reference.
- Please follow the steps in this user manual.
- The foam mattresses are brand new and need to be “broken in”. (i.e. they will soften in time)

Included in Box

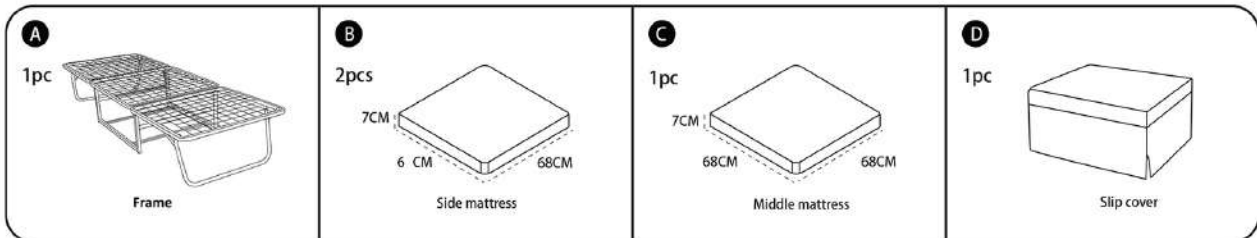

Secure mattresses to frames.

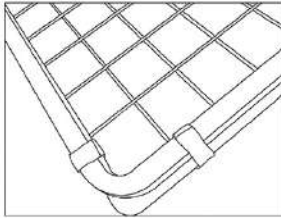

Put on/remove cover.

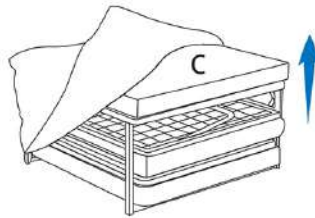

Lock/Unlock legs.

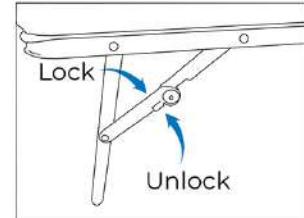

Open into bed position as follows:

Step 1. Open Part C.

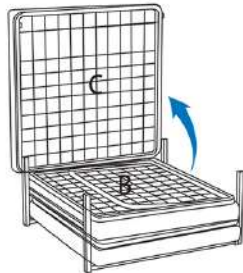

Step 2. Open Top Part B.

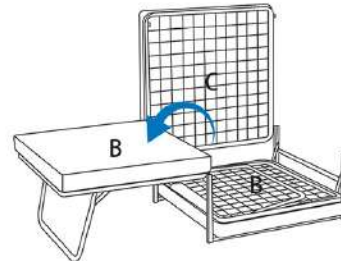

Step 3. Pivot Part C forward slightly to lift bottom Part B into position.

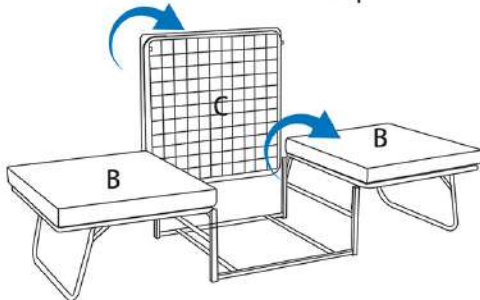

Step 4. Close Part C and ensure leg locks are fully activated.

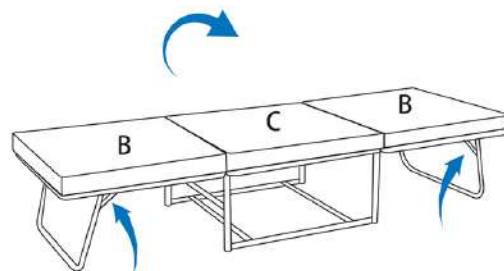

Attention

1. Iron the ottoman cover from the inside only, never iron the outside of the PU leather cover. Iron on a low temperature setting only.
2. Always keep babies and toddlers away from folding beds for their own safety.
3. Please keep away from fire and heat sources.
4. For your own safety, the bed must not be altered or modified.
5. Please only allow one person to sleep on the bed at a time.
6. For your own safety, no jumping on the product.
7. Please ensure the mattress covers are secured to the base using the velcro straps.