

# ASSEMBLY INSTRUCTION

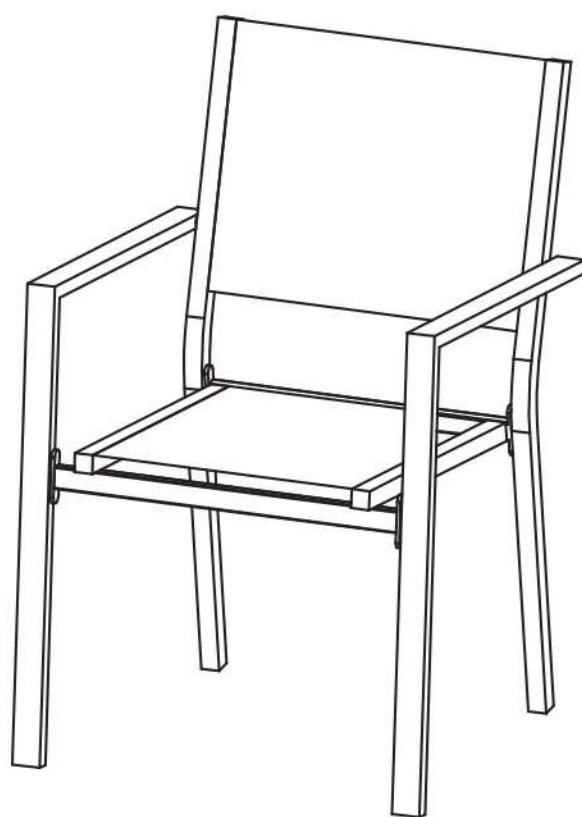

## OTF-551A



2 PERS.



30 MIN

## Important Tips and Maintenance



1. Keep children and animals away from working area as smaller parts may cause choking if swallowed



2. Never place liquids or anything damp upon furniture as it will mark. Ensure a coaster or running is beneath.



3. Never use ammonia based cleaning products as it will damage the finish.

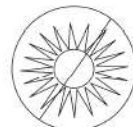

4. To avoid fading, keep furniture out of direct sunlight.



5. Use a soft or damp cloth (dry cloth) when wiping or cleaning surface.



6. Two person are required



7. Lay a soft mat down to protect the furniture pieces before and during assembly.

Assembling flat pack furniture could be slightly stressful. We recommend treating yourself to a cup of tea and taking a short rest after a few steps have been completed. Few tips to the assembling:

\*Get ready

Space / Protect / Light / Safety

\*Pre-battle prep

It is not tackling Mt Everest or running an ultra marathon but needs a certain amount of calm.

\*Sort it out

Divide up the pieces of furniture before you start into relevant piles. Sorting and counting the screws.

\*Read up

The instructions are just pictures with arrows and numbers, but familiarising yourself with the flow of the work stops you from making mistakes.











\*On your marks

Remember, slow and steady wins the race

Feel free to contact your seller with any questions or comments



DO NOT USE any type of power tool when assembling the furniture.  
It is easy to insert screws too far and cause damage.

<p>A</p>  <p>4pcs</p>	<p>B</p>  <p>4pcs</p>	<p>C</p>  <p>4pcs</p>	<p>D</p>  <p>4pcs</p>	<p>E</p>  <p>M6*18 32pcs</p>
<p>F</p>  <p>M8*40 8pcs</p>	<p>G</p>  <p>M6 32pcs</p>	<p>H</p>  <p>M8 8pcs</p>	<p>I</p>  <p>40pcs</p>	<p>J</p>  <p>1pc</p>

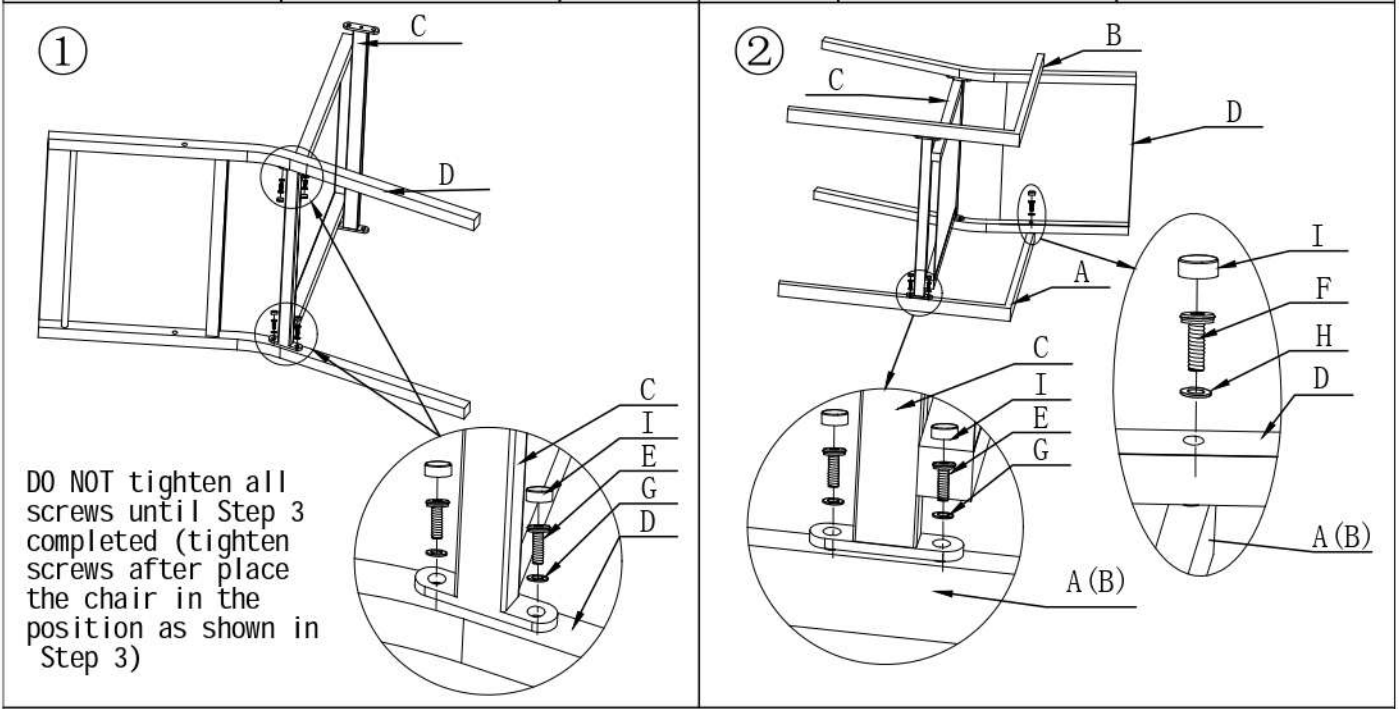

**Great Job, You're done!**

Don't forget to share how it looks in  
your space and tag us on Instagram.