

TIPS

- 1 Please review all parts and hardware before disposing of any packaging.
- 2 Check to be sure that all parts and hardware are complete before you start assembly.
- 3 Before beginning assembly, separate each type of screw.
- 4 **Using a screw that is too long will cause damage.**
- 5 Carefully study the screw diagrams below.
- 6 You may receive extra hardware with your unit.
- 7 Place all parts on a clean and smooth surface to avoid the parts from being scratched.
- 8 Keep the product away from heat and humidity.
- 9 Light blue stains and natural wood knots on the product are not considered defects.
- 10 Before start assembly, please categorize the hardware.

Required :
5 minutes

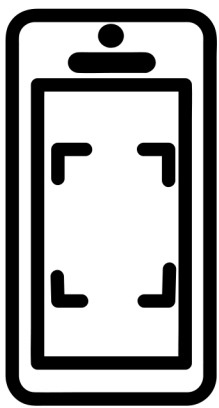
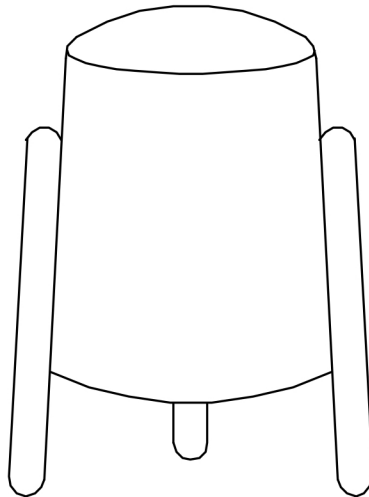

SCAN ME



For Step-By Step Real
Photo Assembly Instructions.

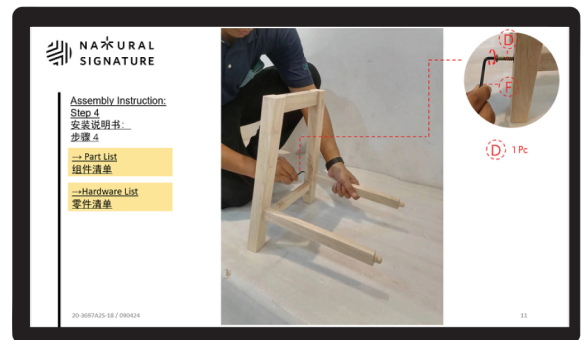

PART LIST

A Seat Cushion
1Pc



B Stool Leg
3Pcs

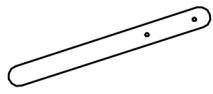

HARDWARE LIST *Before start assembly, please categorize the hardware.

a JCBB Screw M8 x 40mm
6Pcs



b Spring Washer 5/16"
6Pcs



c Flat Washer 5/16"
6Pcs



d Allen Key M5
1Pc



ASSEMBLY INSTRUCTIONS

1 STEP 1

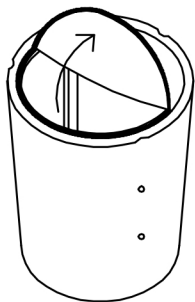

*Open the black cloth

2 STEP 2

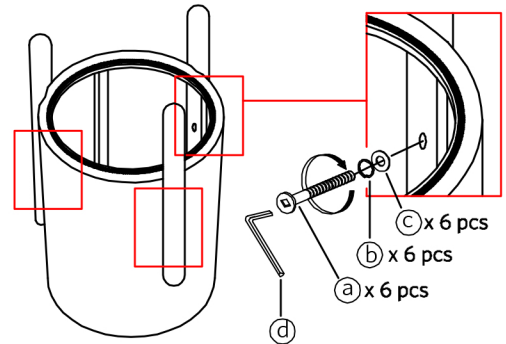

3 STEP 3

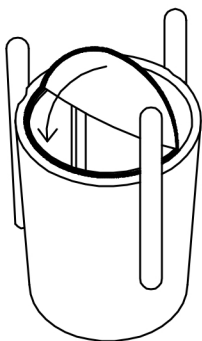

*Tape the black cloth to velcro

4 STEP 4

