

Assembly Instruction

Accent chair

IHD-AC05

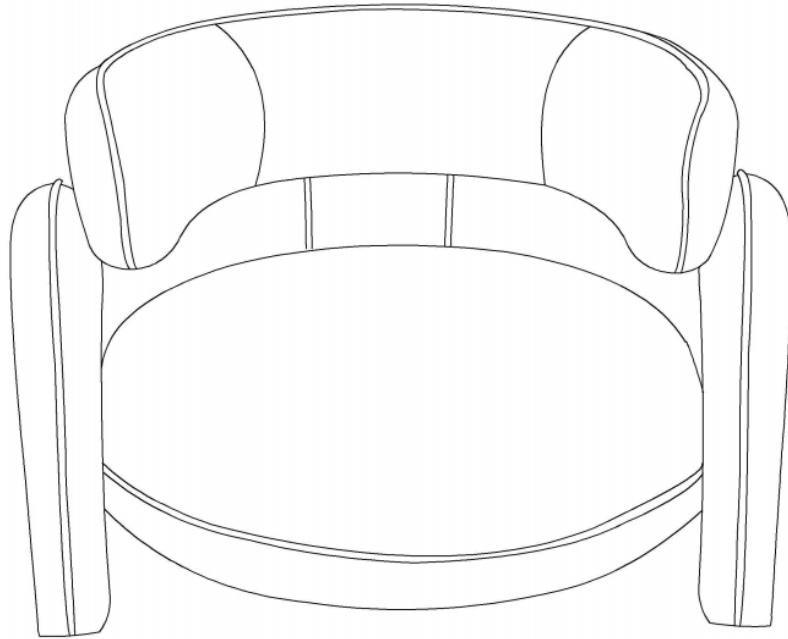

Customer Service Before Return:

If part is missing or damaged, or you need help with assembly, please do not hesitate to contact us.

SELLER CONTACT INFORMATION:

contacts@ihomdec.com

Component list

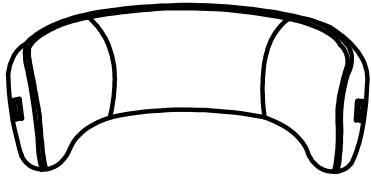
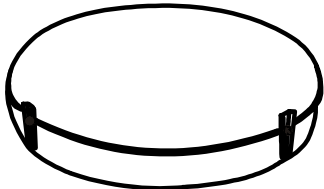
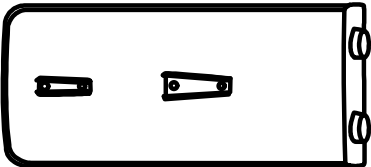
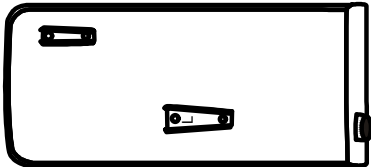
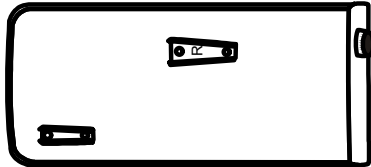
LABEL		DESCRIPTION	QTY
A		Back	1
B		Seat	1
C		Middle leg	1
D		Left armrest	1
E		Right armrest	1

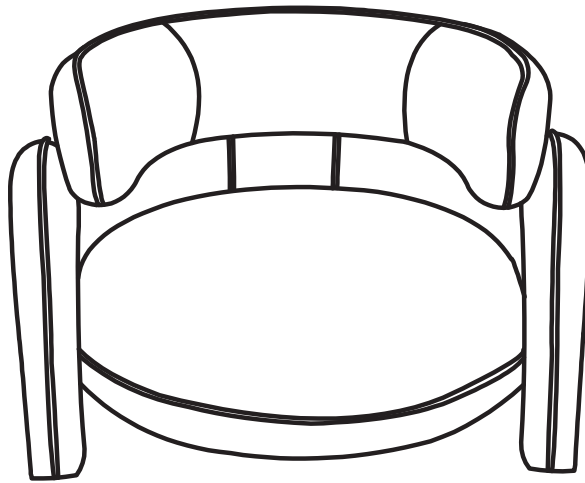

SAFETY NOTICE:
THIS CHAIR IS DESIGNED FOR SITTING ON THE REAR PART ONLY.
DO NOT STAND ON THE SEAT AS THERE IS A RISK OF TIPPING FORWARD.

Step 1: Put the part(D)with sticker L into part (B)-the side with sticker L

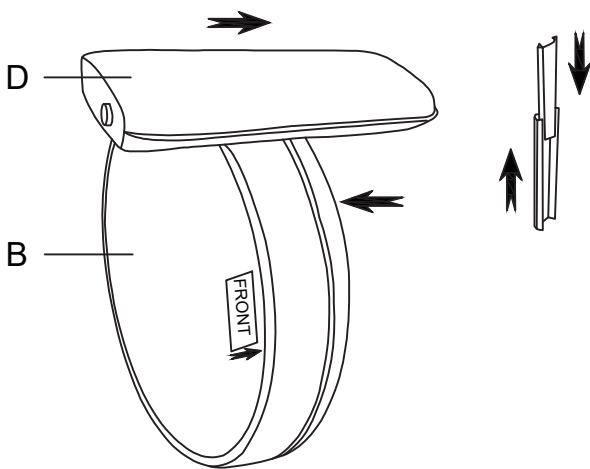

Step 2: Put the part(E)with sticker R into part (B)-the side with sticker R

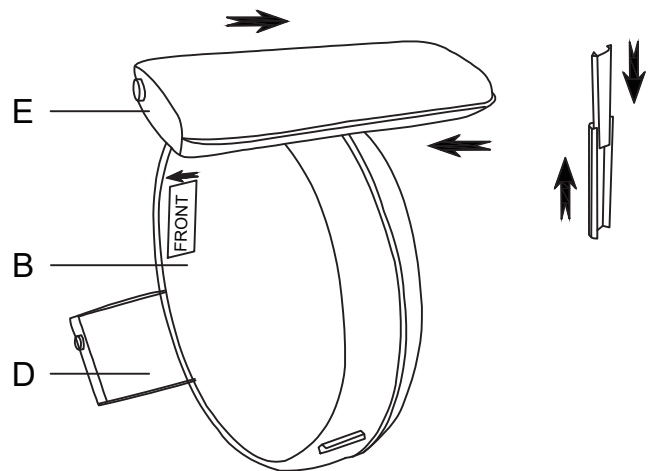

Step 3: Put the part(C) into back of part (B)
as below direction

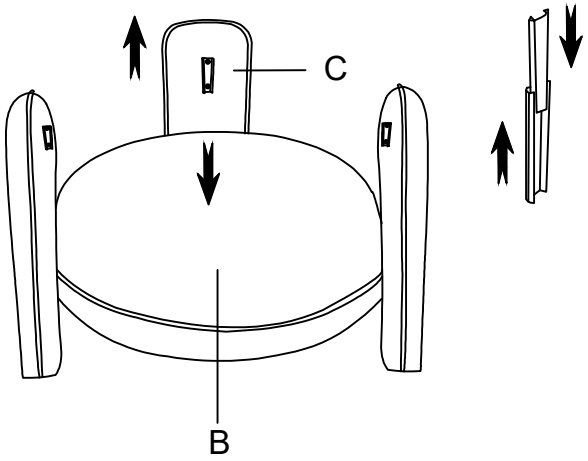

Step 4: Put middle area of the part(A) into part (C),
NOT too tight, 50% is OK

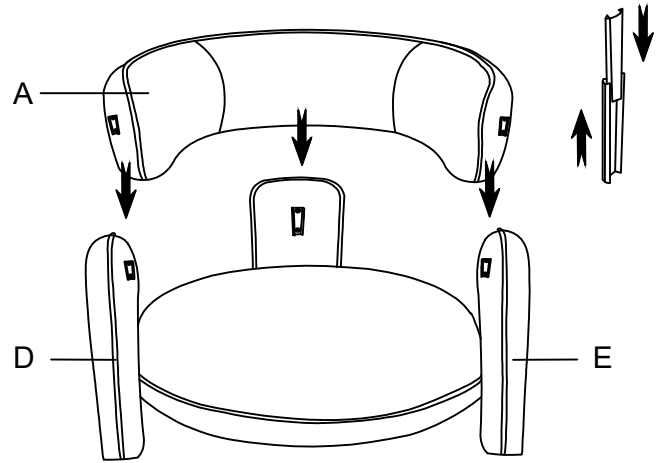

Step 5: Then put two sides of the part(A) into part
(D)&(E) meanwhile, **NOT** too tight, 50% is OK

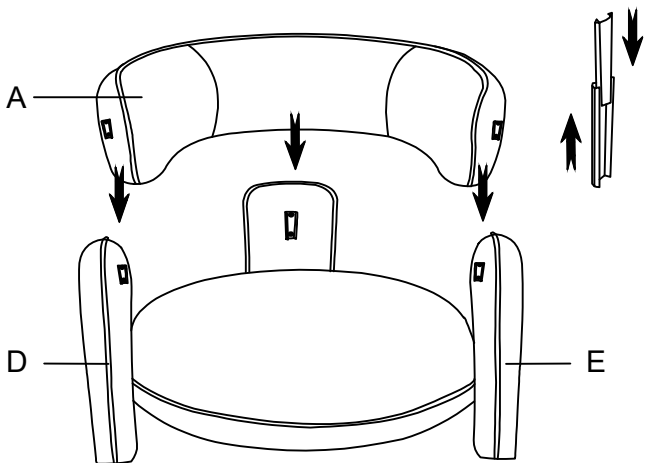

Step 6: Push the parts (A) & (B) as below direction,
tighten into 100%

