

Assembly Instruction

Accent Chair

SKU: IHD-JKAC22

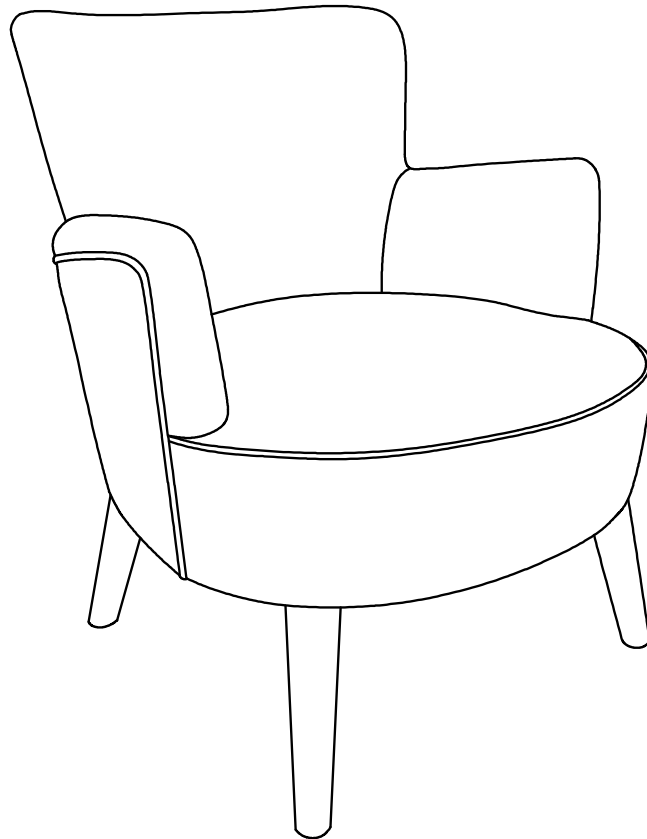

Customer Service Before Return:

If part is missing or damaged, or you need help with assembly, please do not hesitate to contact us.

SELLER CONTACT INFORMATION:





contacts@ihomdec.com

Before Assembly

IMPORTANT NOTE:

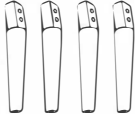
- Make sure all parts and hardware are included and free of obvious Defect before disposing of any packaging
- Place all wooden parts on a clean and smooth surface such as a rug or carpet to avoid the parts from being scratched.
- DO NOT tighten all screws and bolts until completely assembled.
- Assembly will require two people.

PART LIST

A	B	C	D	E	F	
		 M8x60MM			 M8	
1PC	4PC	8PC	8PC	8PC	1PC	

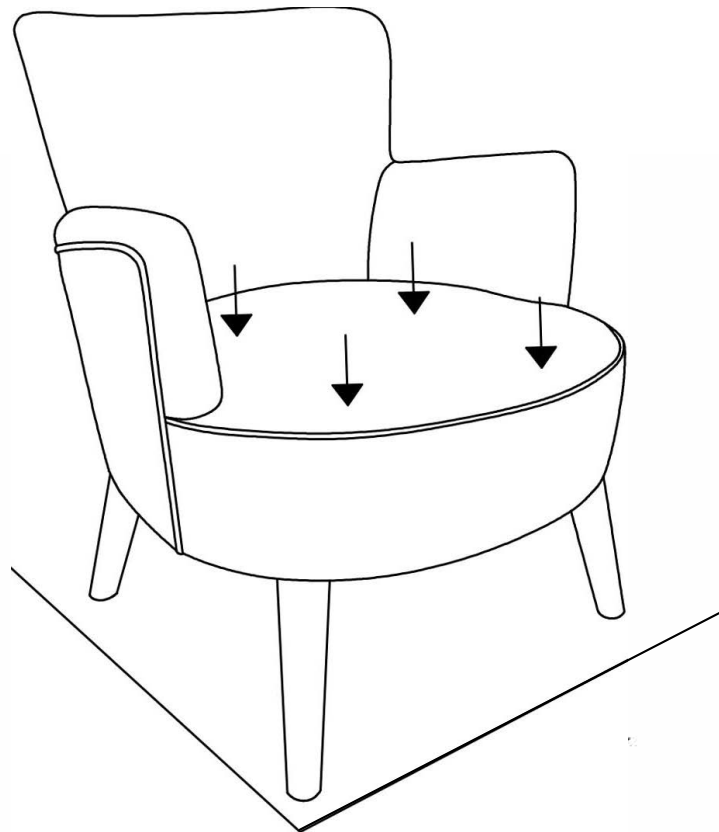

NOTED:

1. Do not fully tighten all bolts until all parts are in place. Failure to follow these instructions may cause the bolt to misalign during assembly.
2. To prevent injury and property damaged from unexpected tipping of furniture, we highly recommend installation of the anti-tip kit included with this product.

Assembly Instruction

Step 1

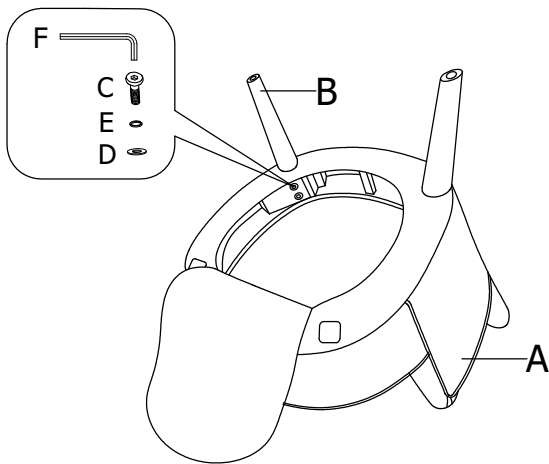
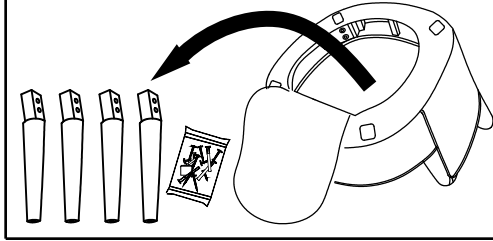

Step 2

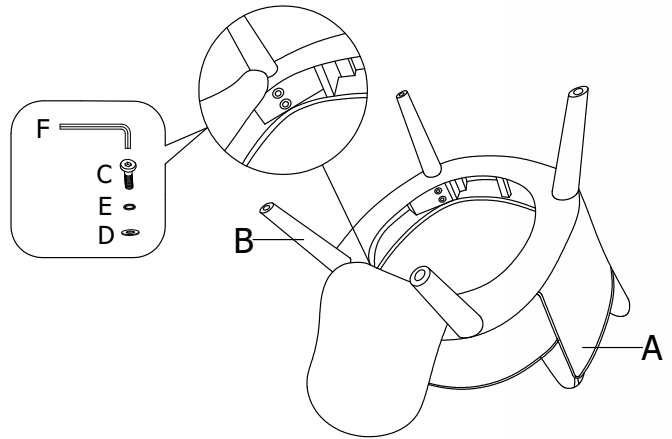

Step 3

