

Assembly Instruction  
Accent chair  
IHD-TB03

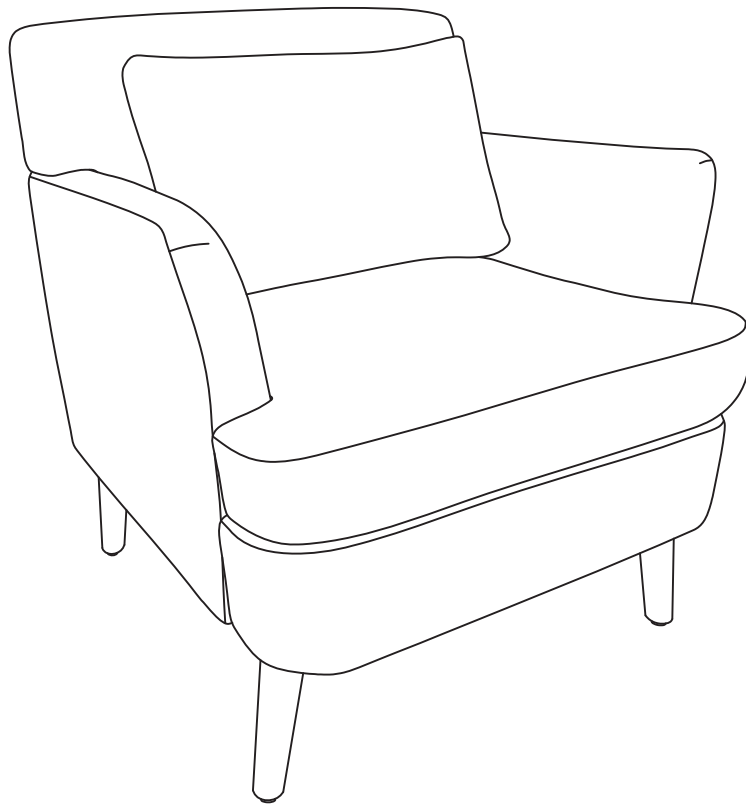





**Customer Service Before Return:**

If part is missing or damaged, or you need help with assembly, please do not hesitate to contact us.

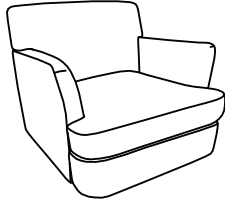
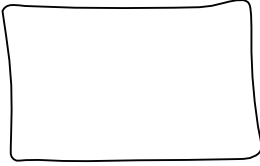
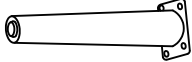
**SELLER CONTACT INFORMATION:**

[contacts@ihomdec.com](mailto:contacts@ihomdec.com)

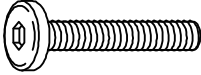
Component List			
LABEL		DESCRIPTION	QTY
A		Chair body	1
B		Cushion	1
C		Front leg	2
D		Rear leg	2

Component List			
LABEL		DESCRIPTION	QTY
H1		Screw M6x20mm	16
H2		Allen key	1

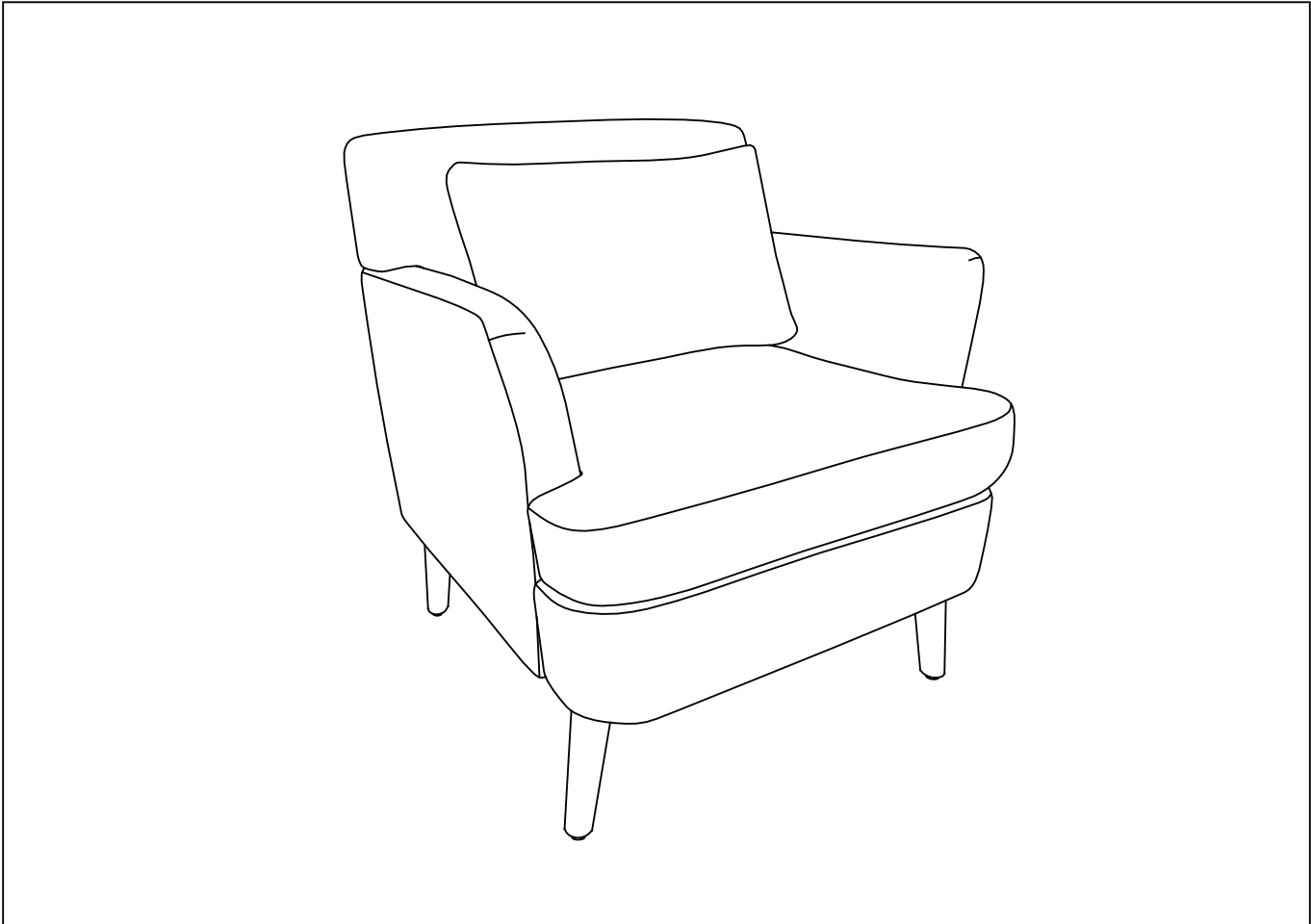

Step 1:

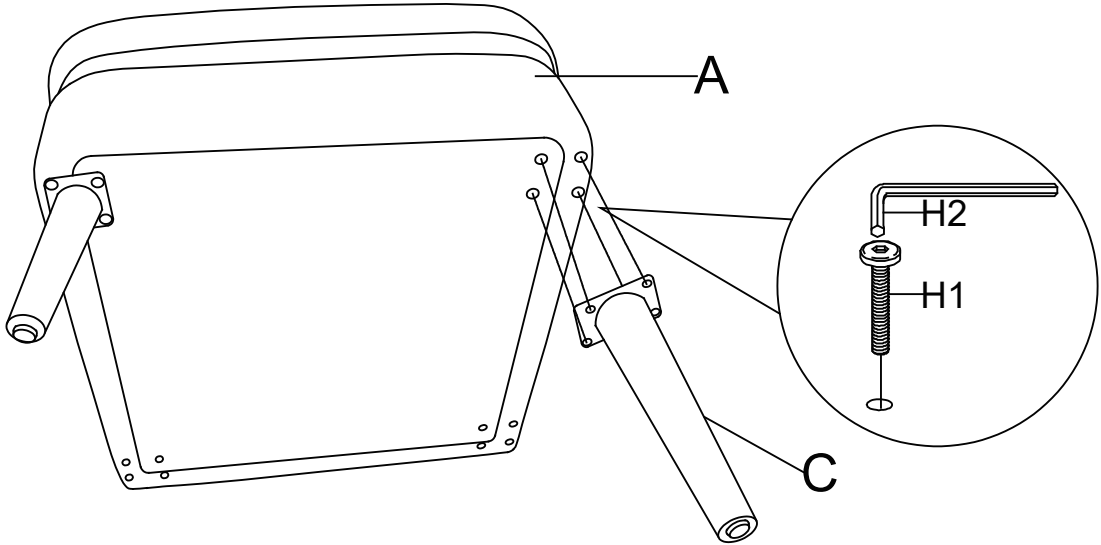

## Step 2:

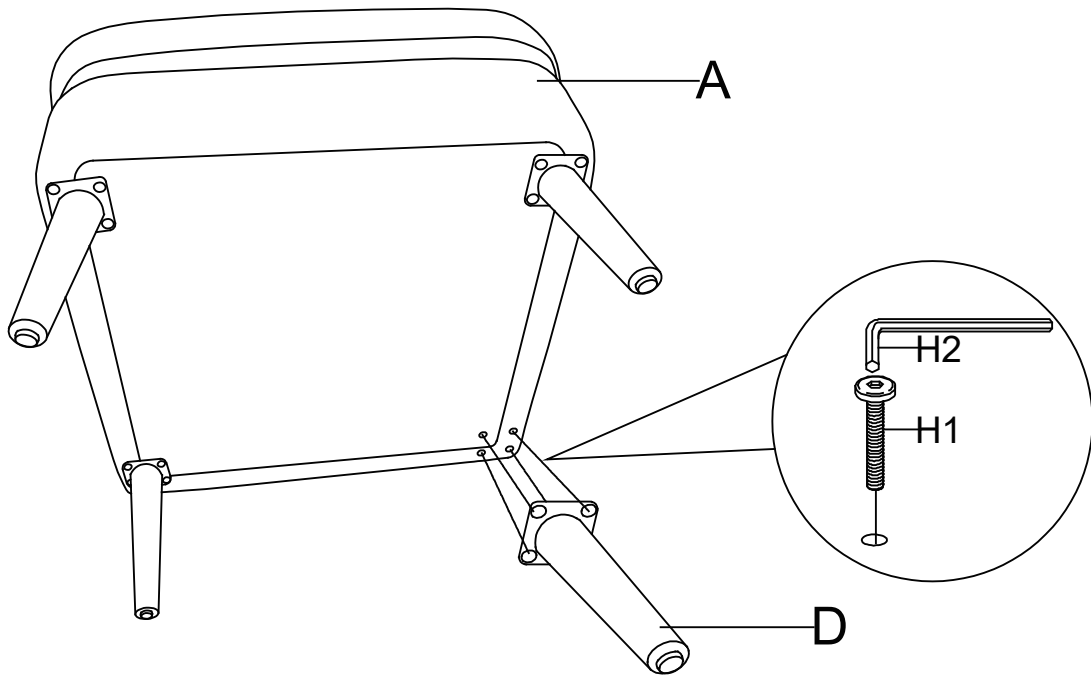

## Step 3:

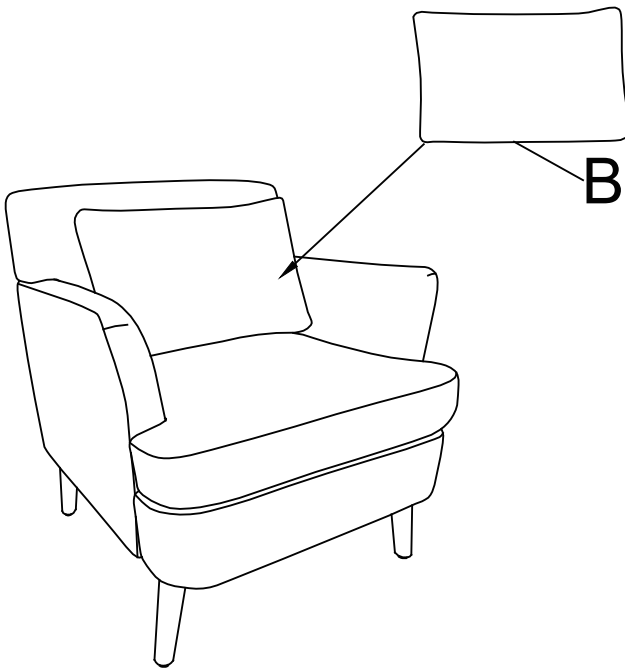

## Step 4:

