

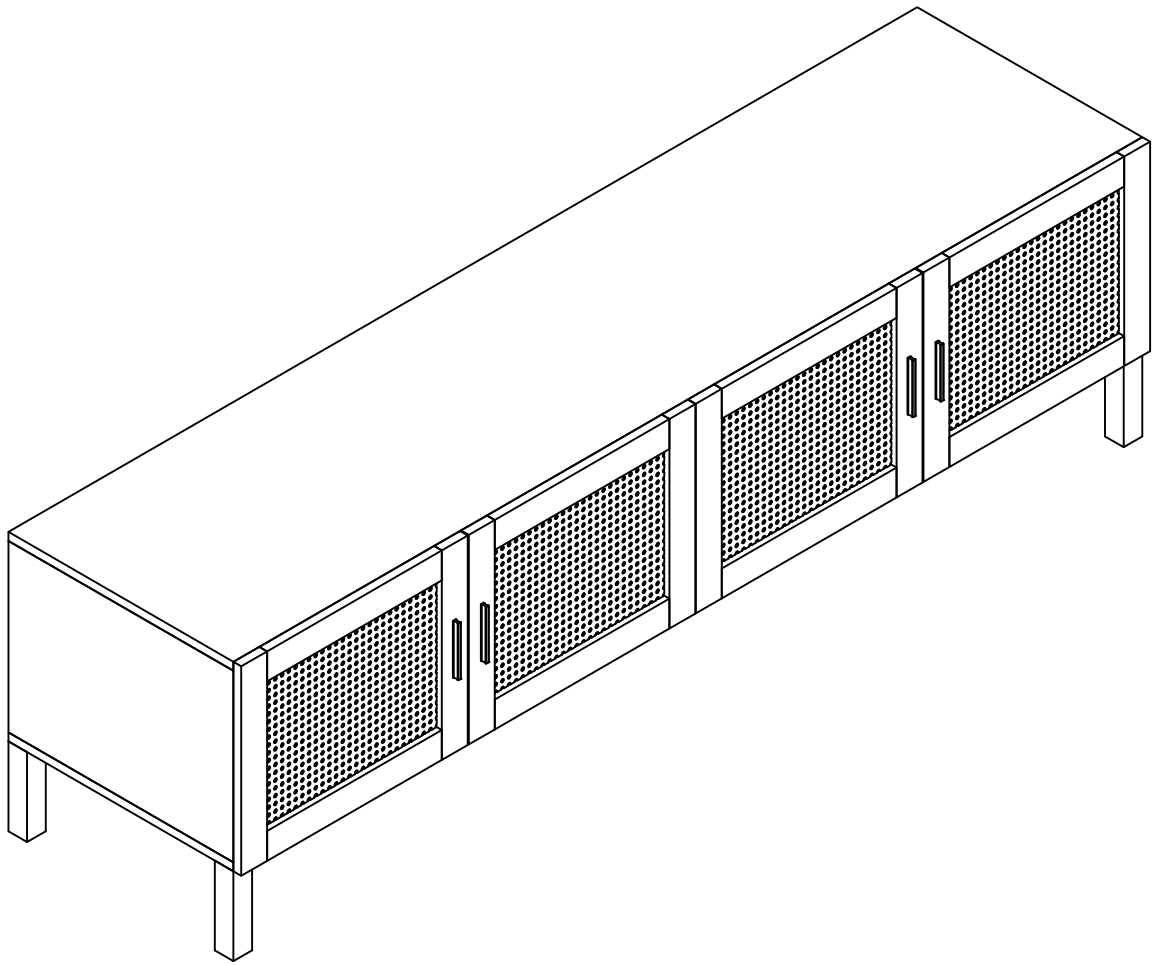

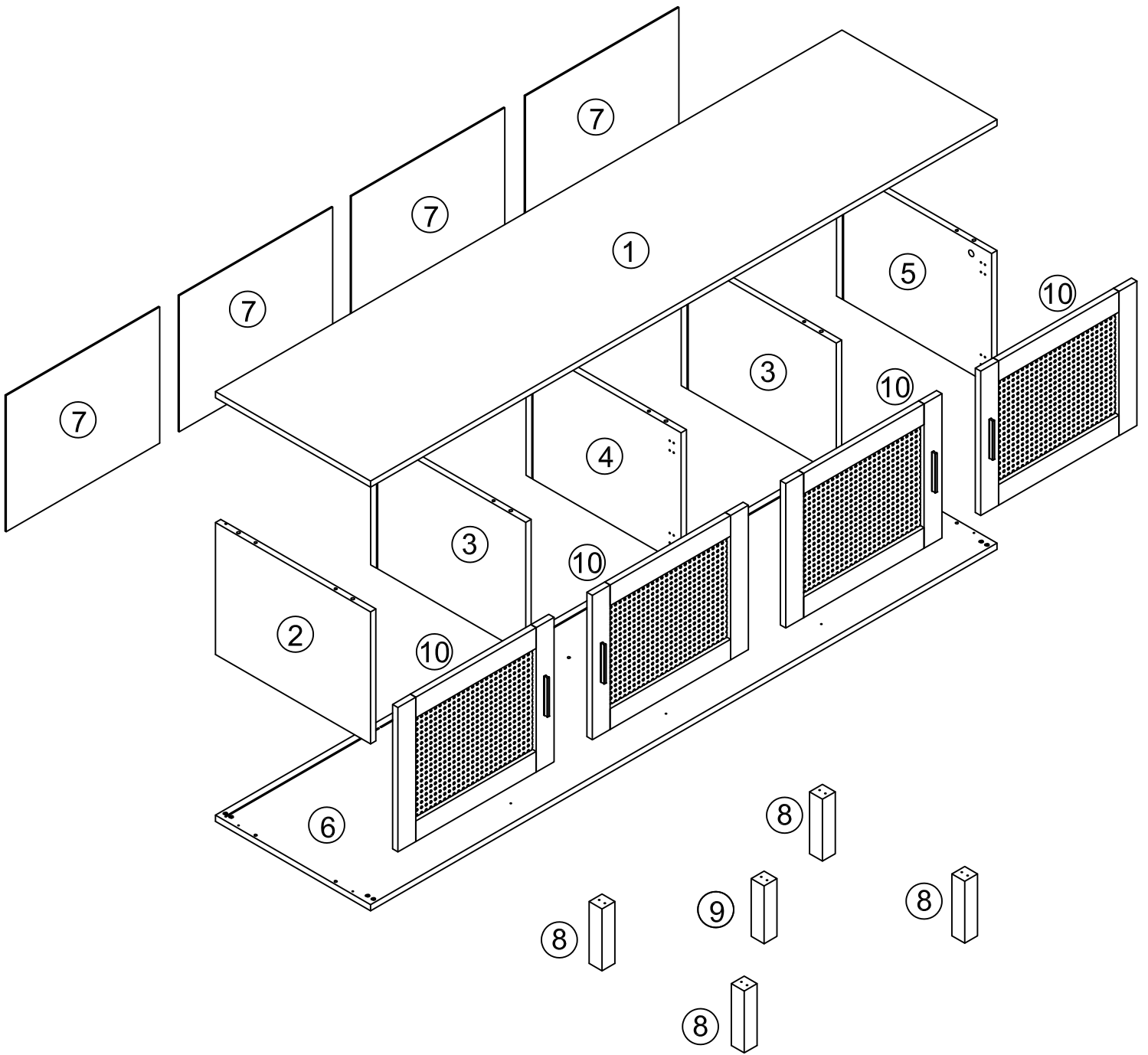







Item No. 10003622  
10003617



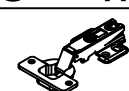
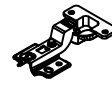

A x10	B x10	C x20	D x4	E x8	F x20	G x4
						
H x4	I x48	J x1	K x16	L x16		
						

# Step 1

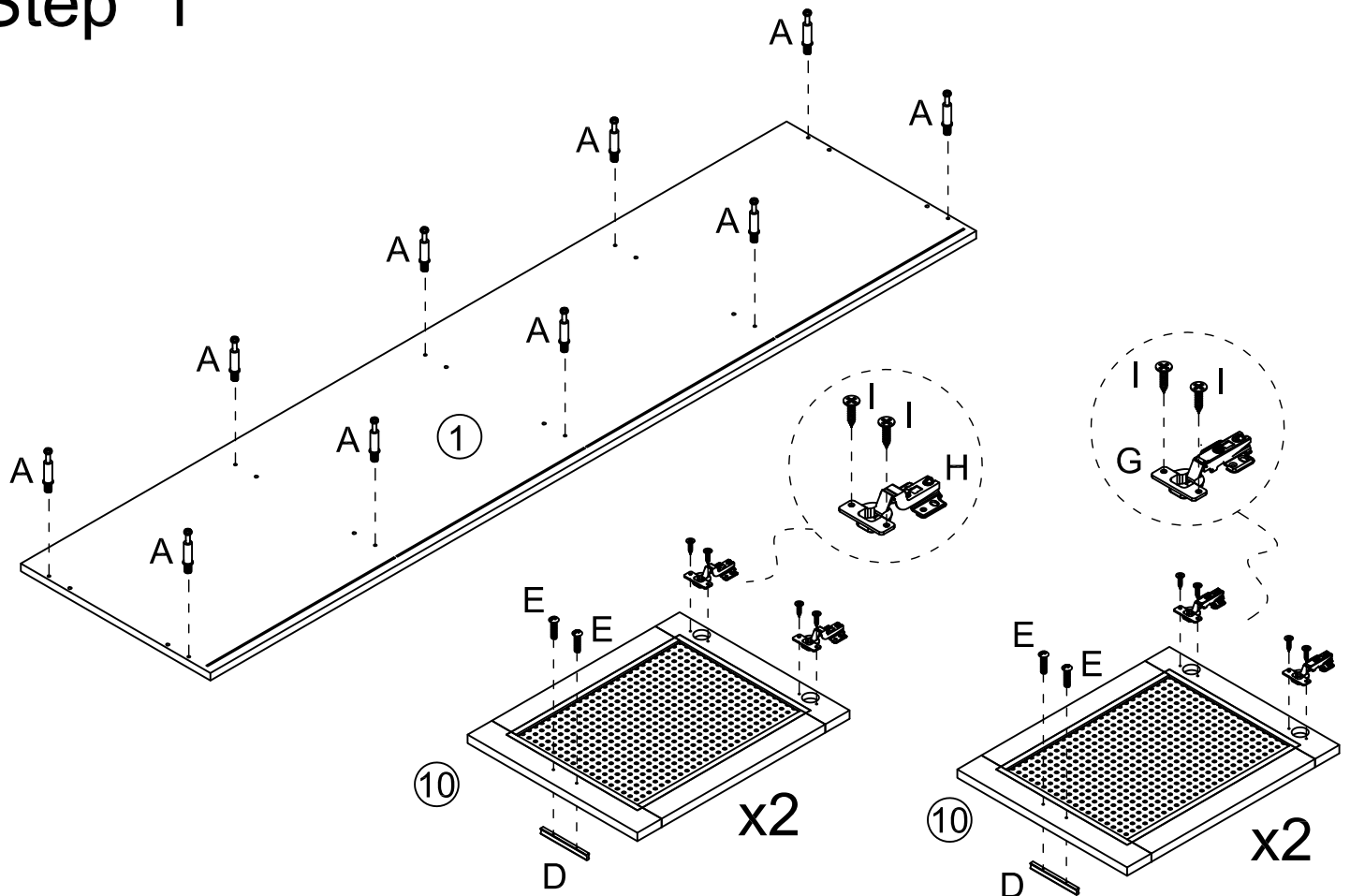

# Step 2

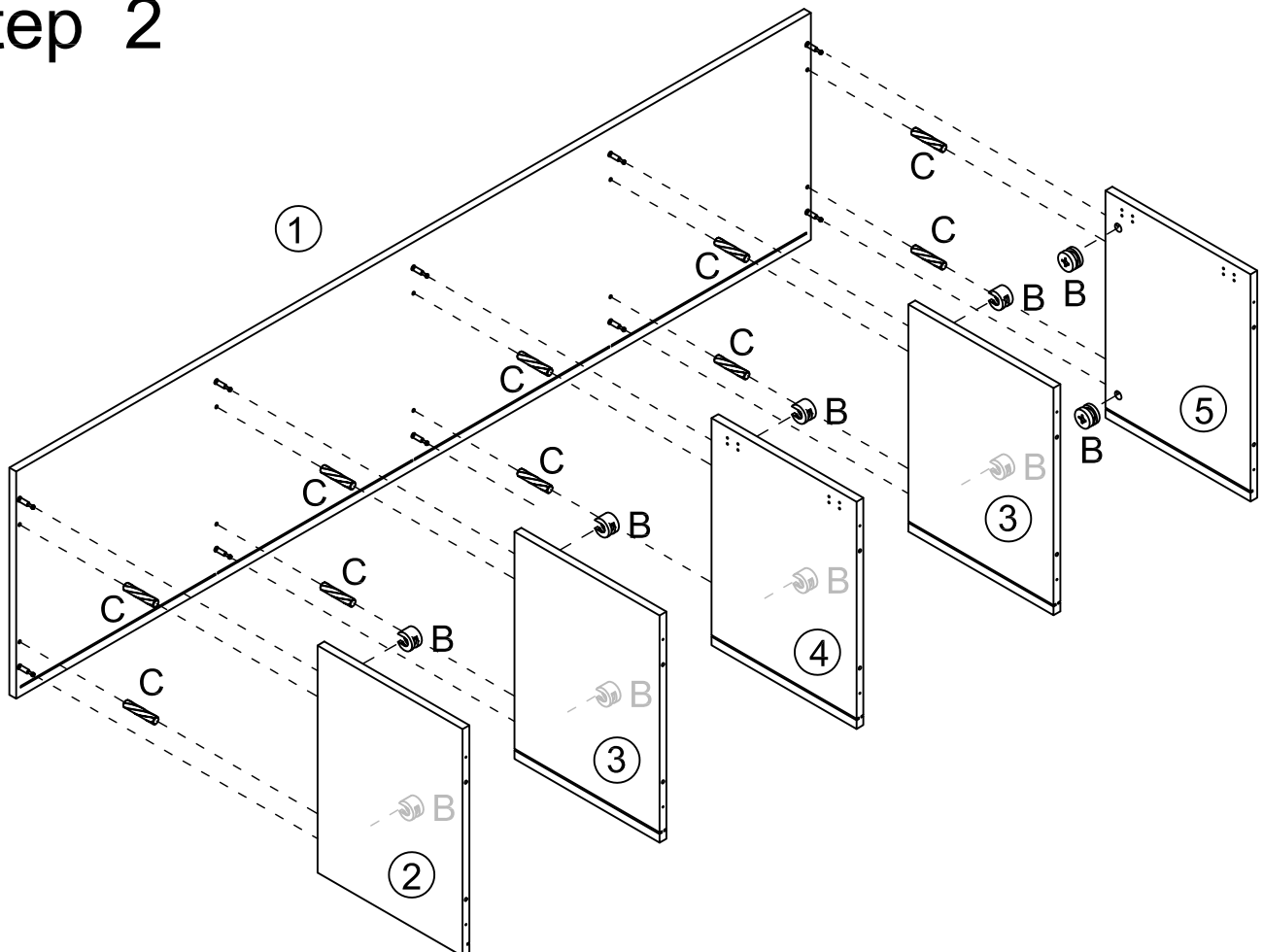

# Step 3

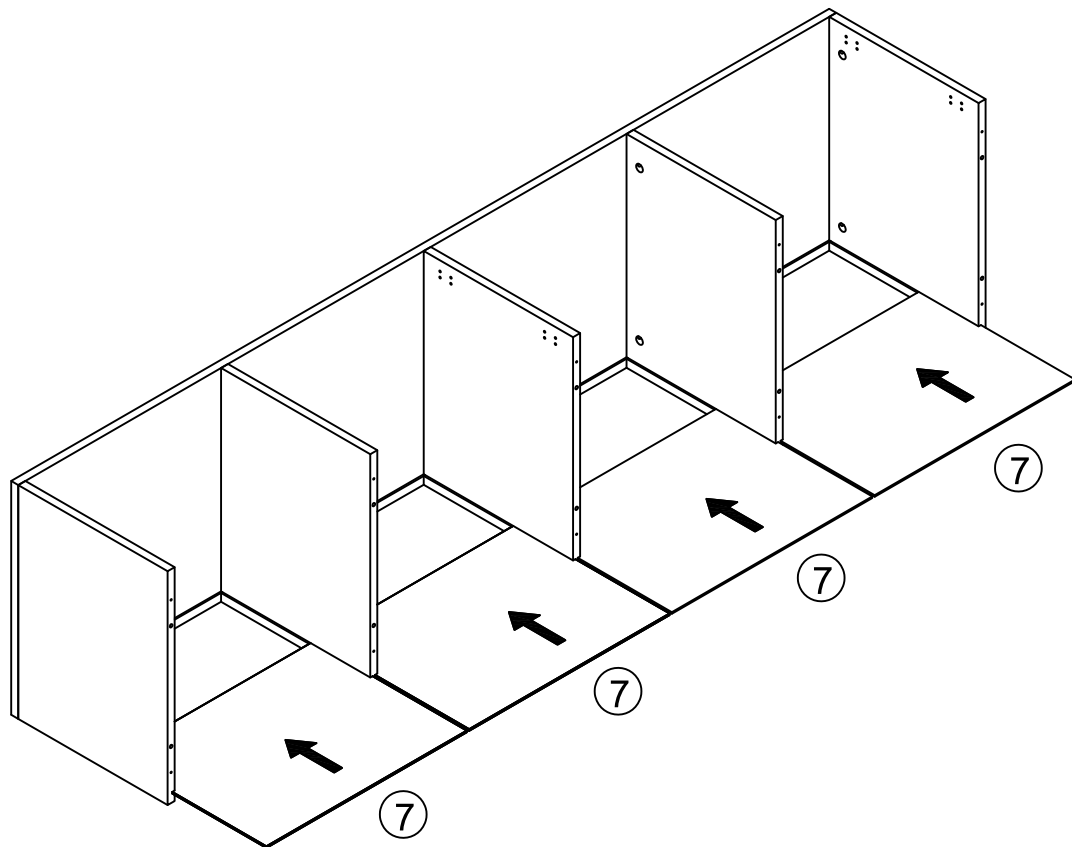

# Step 4

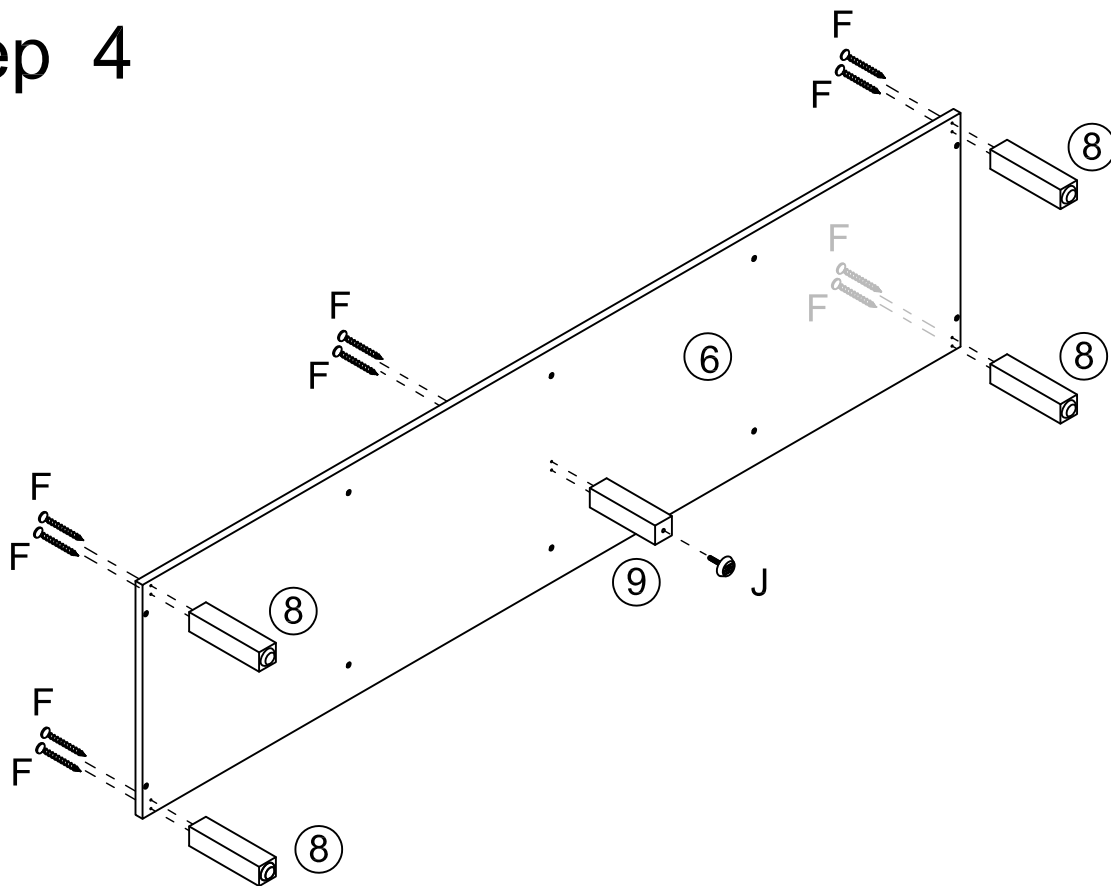

# Step 5

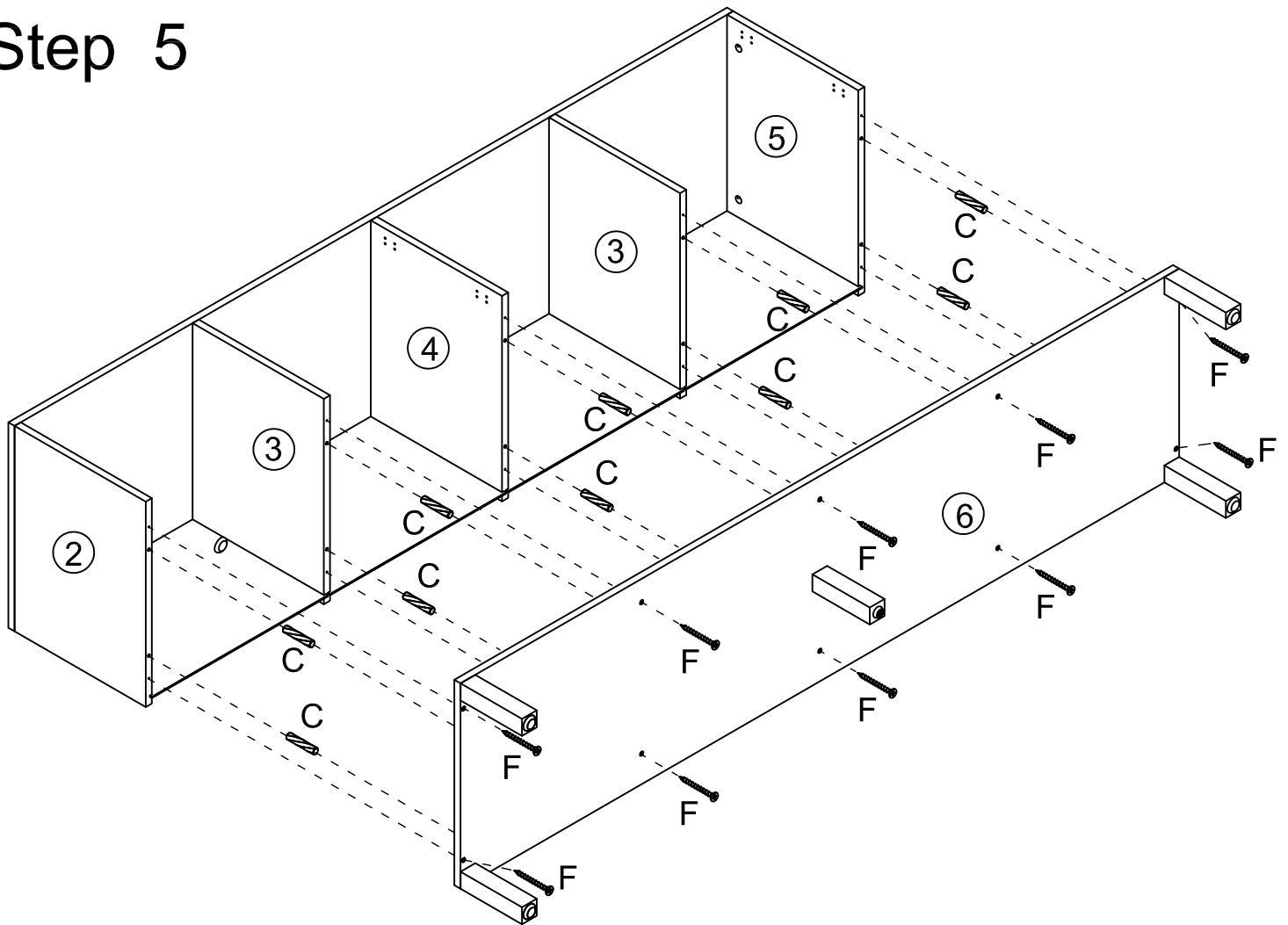

# Step 6

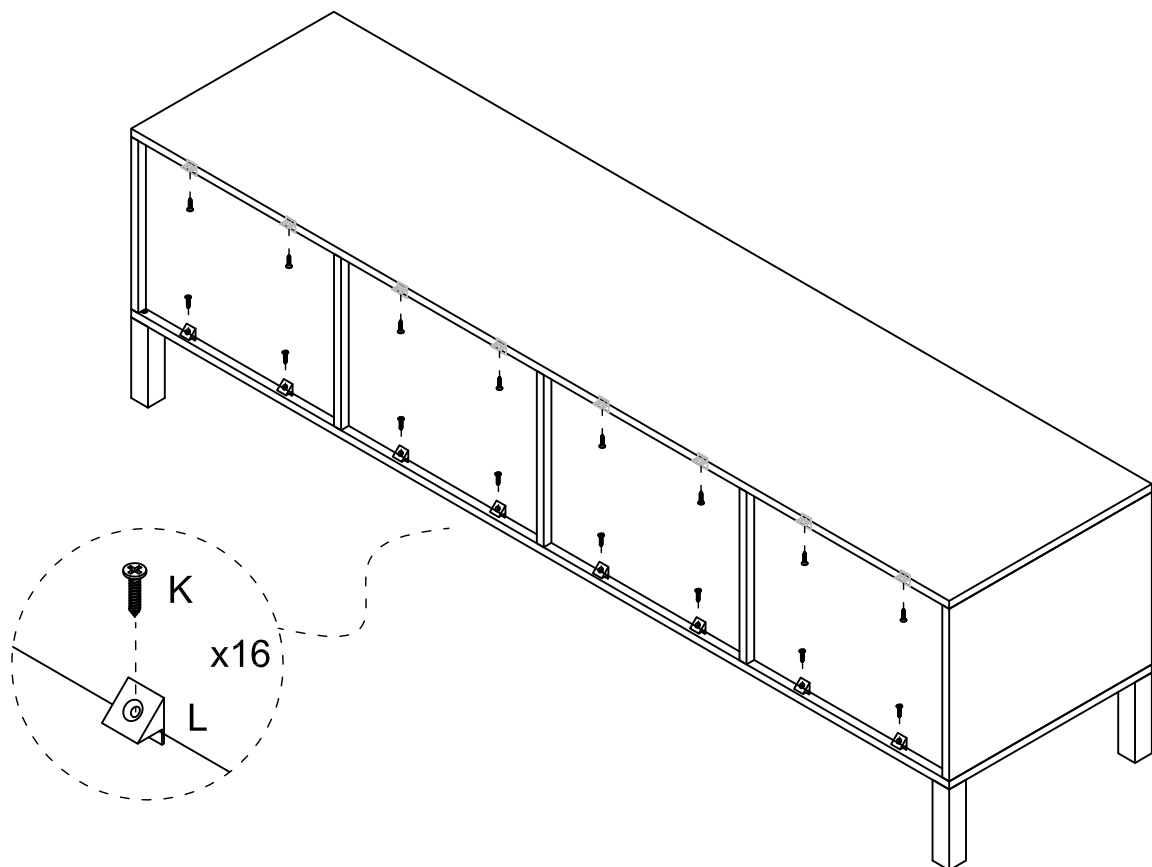

# Step 7

