













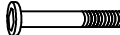

A		M8X20	X20
B		M8X40	X4
C		M8X50	X1
D		M6X25	X2
E		M6X35	X4

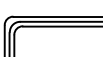

F		M6X50	X8
G		M6X50	X2
H		M8	X4
J		M6	X10
K			X15

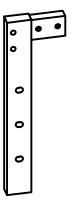
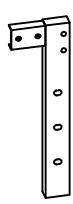
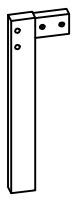
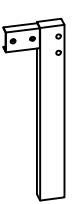
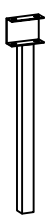
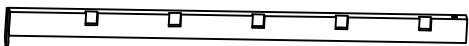
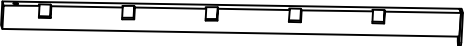

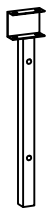
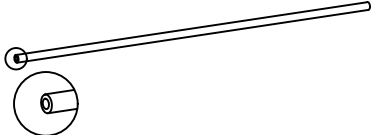
L			X20
M		#5	X2
N		#4	X2

1		X1	2		X1	3		X1	4		X1	5		X1
---	---	----	---	---	----	---	---	----	---	---	----	---	---	----

6		X2	7		X2
---	---	----	---	--	----

8		X2	9		X4	10		X20
---	---	----	---	--	----	----	---	-----

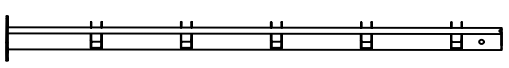
11		X2	12		X2
----	---	----	----	--	----

13		X2	14		X2
----	---	----	----	--	----

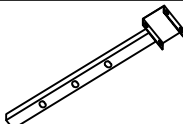
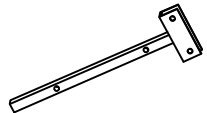
15		X1	16		X1
----	---	----	----	---	----

1

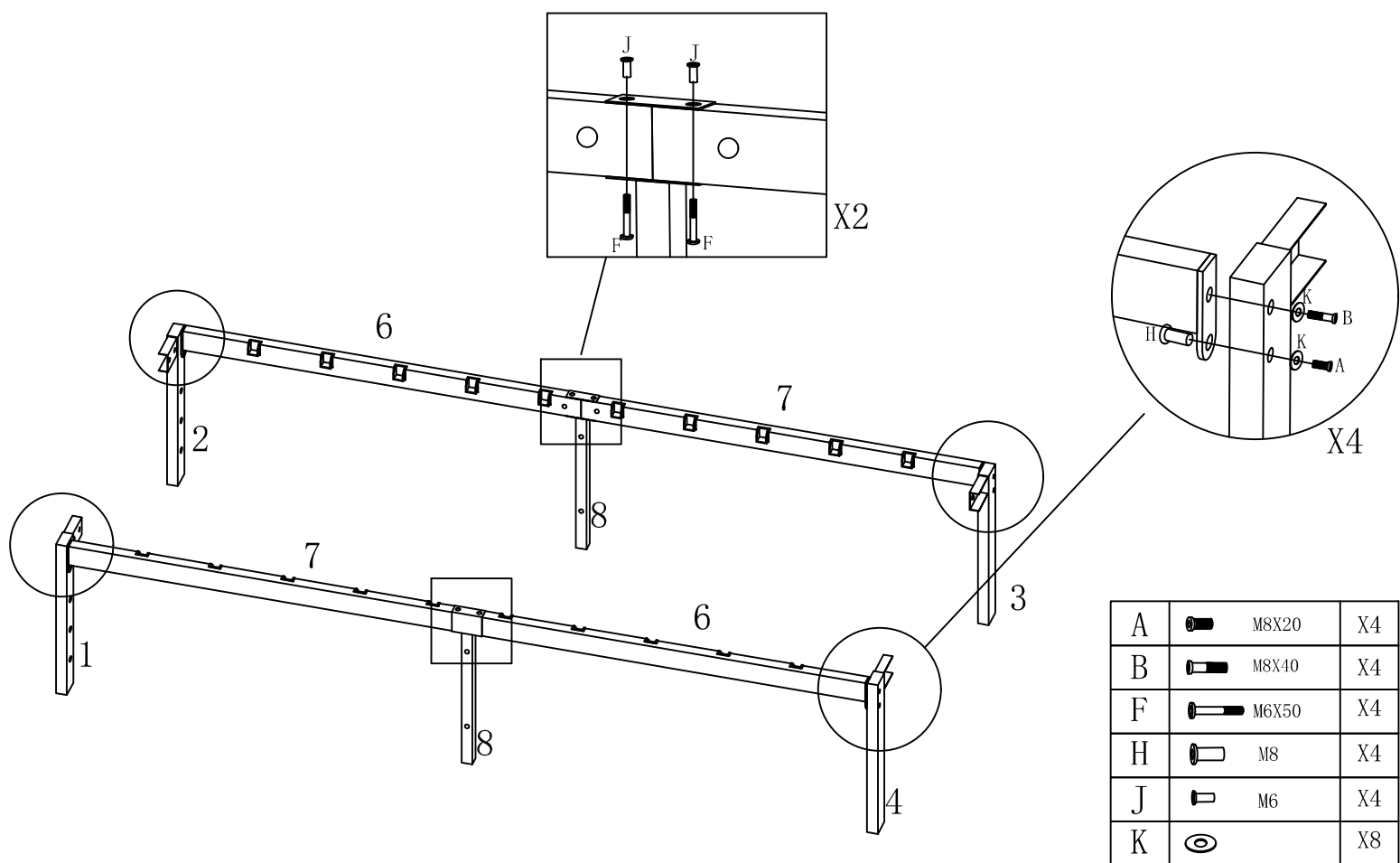

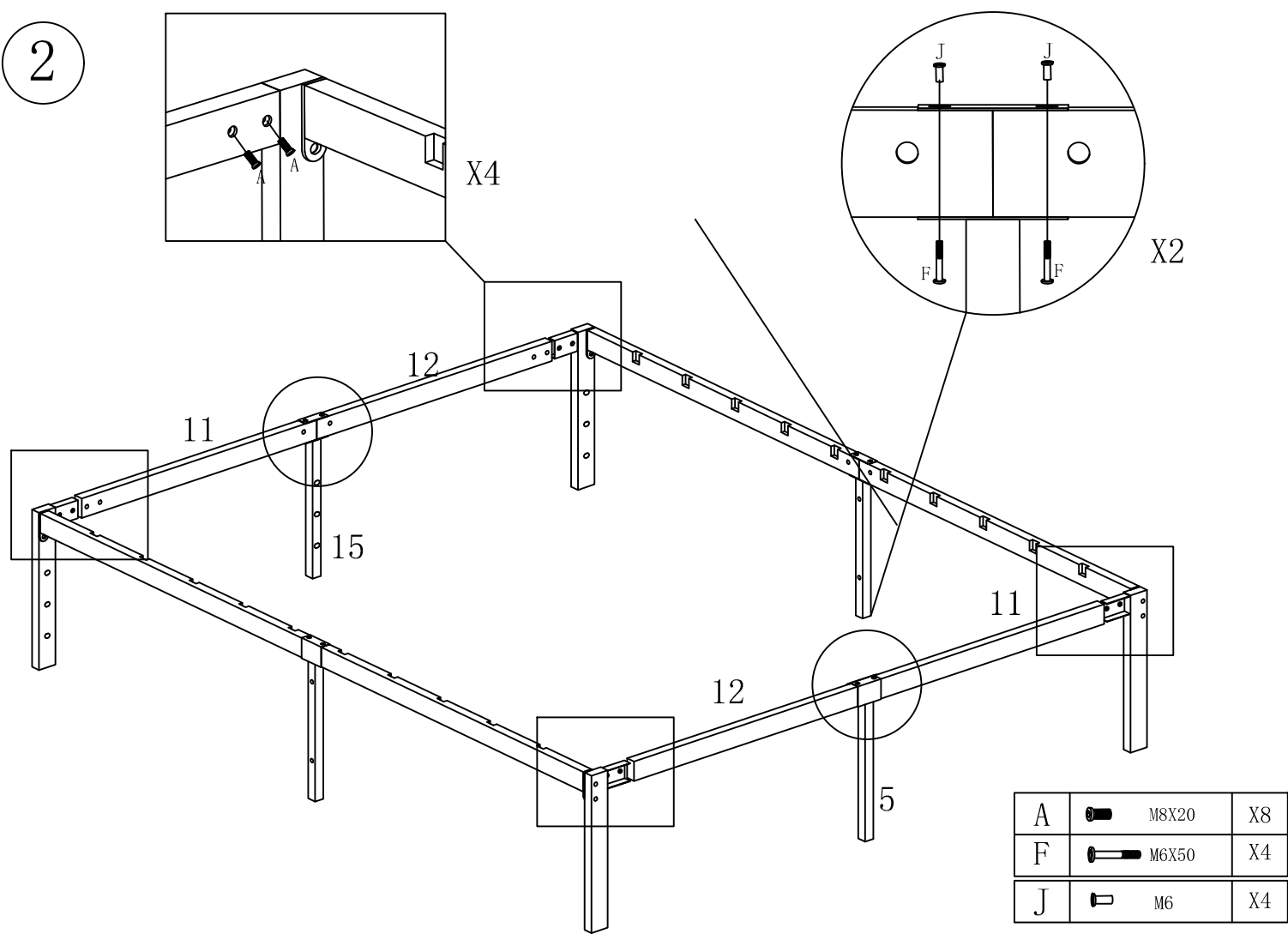

2



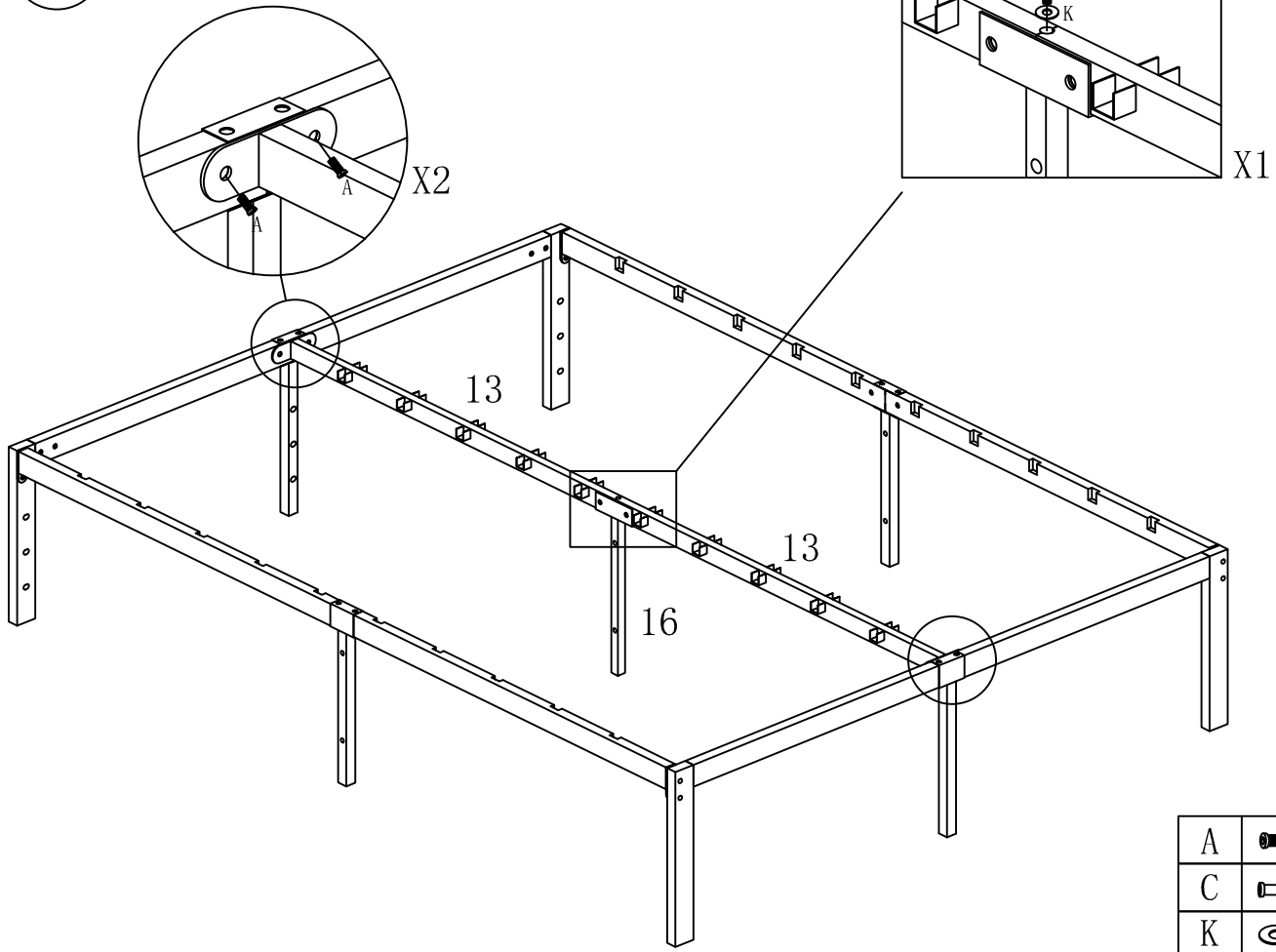



3

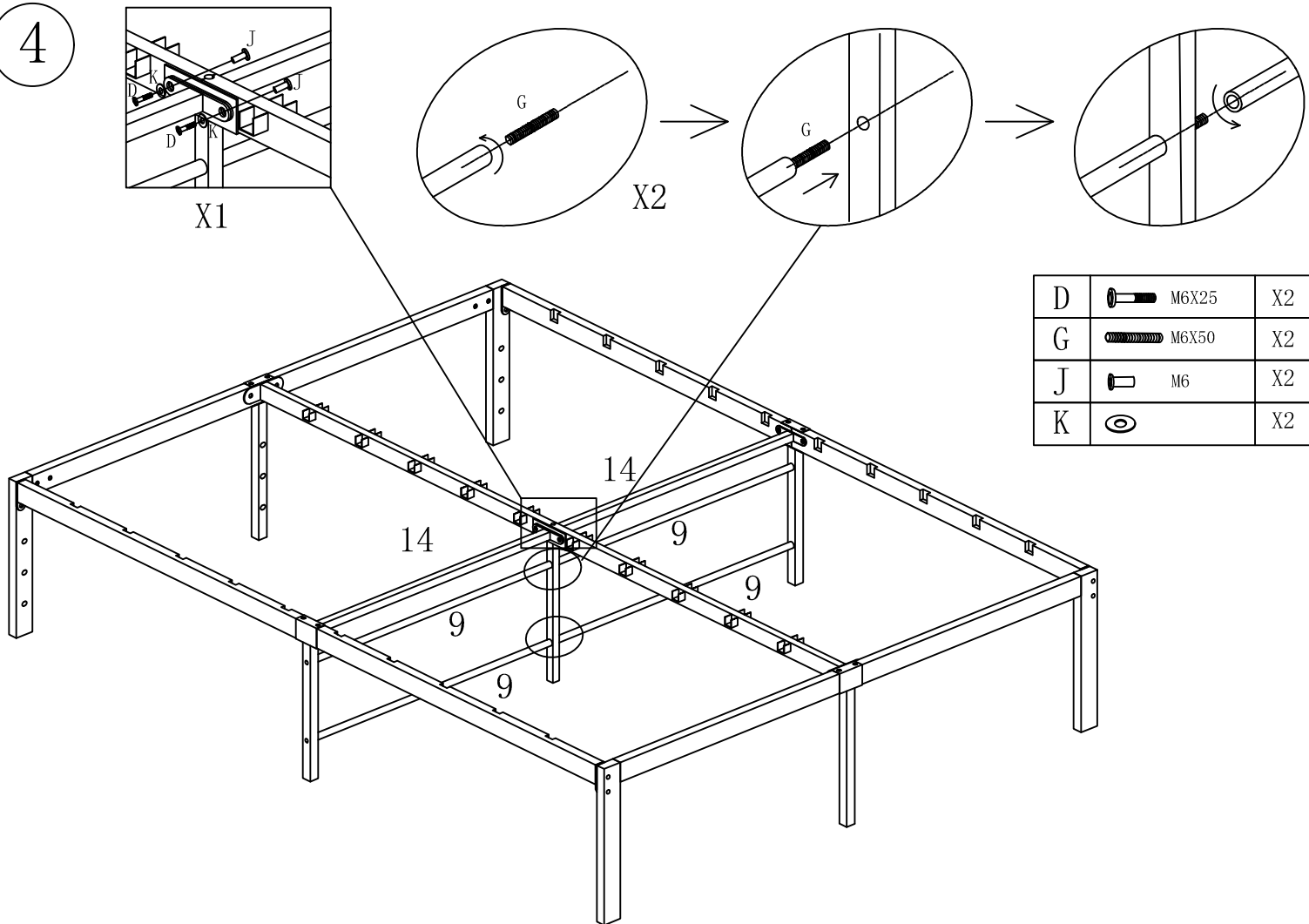

A		M8X20	X4
C		M8X50	X1
K			X1

4



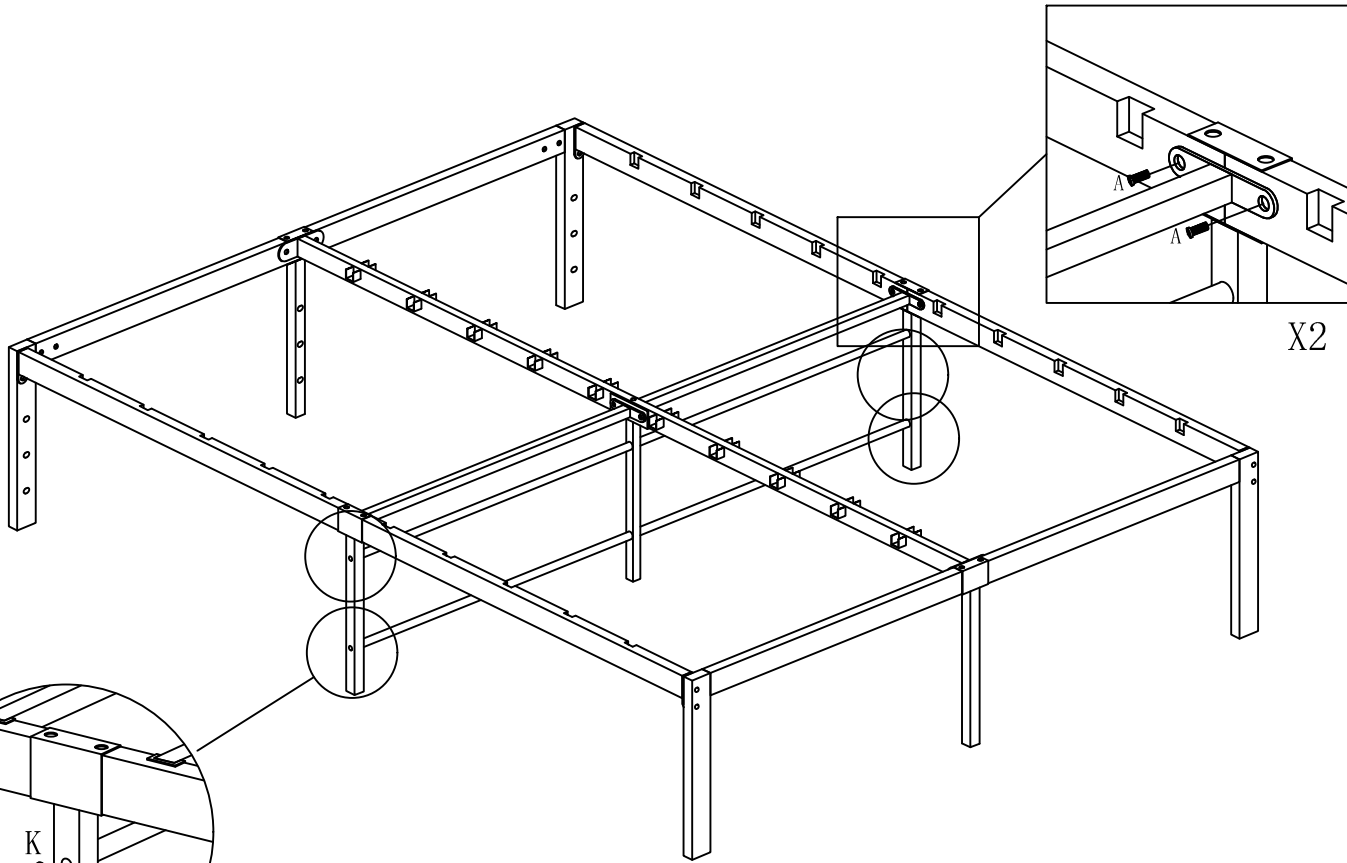

D		M6X25	X2
G		M6X50	X2
J		M6	X2
K			X2

5



X2

X4

A		M8X20	X4
E		M6X35	X4
K			X4

6

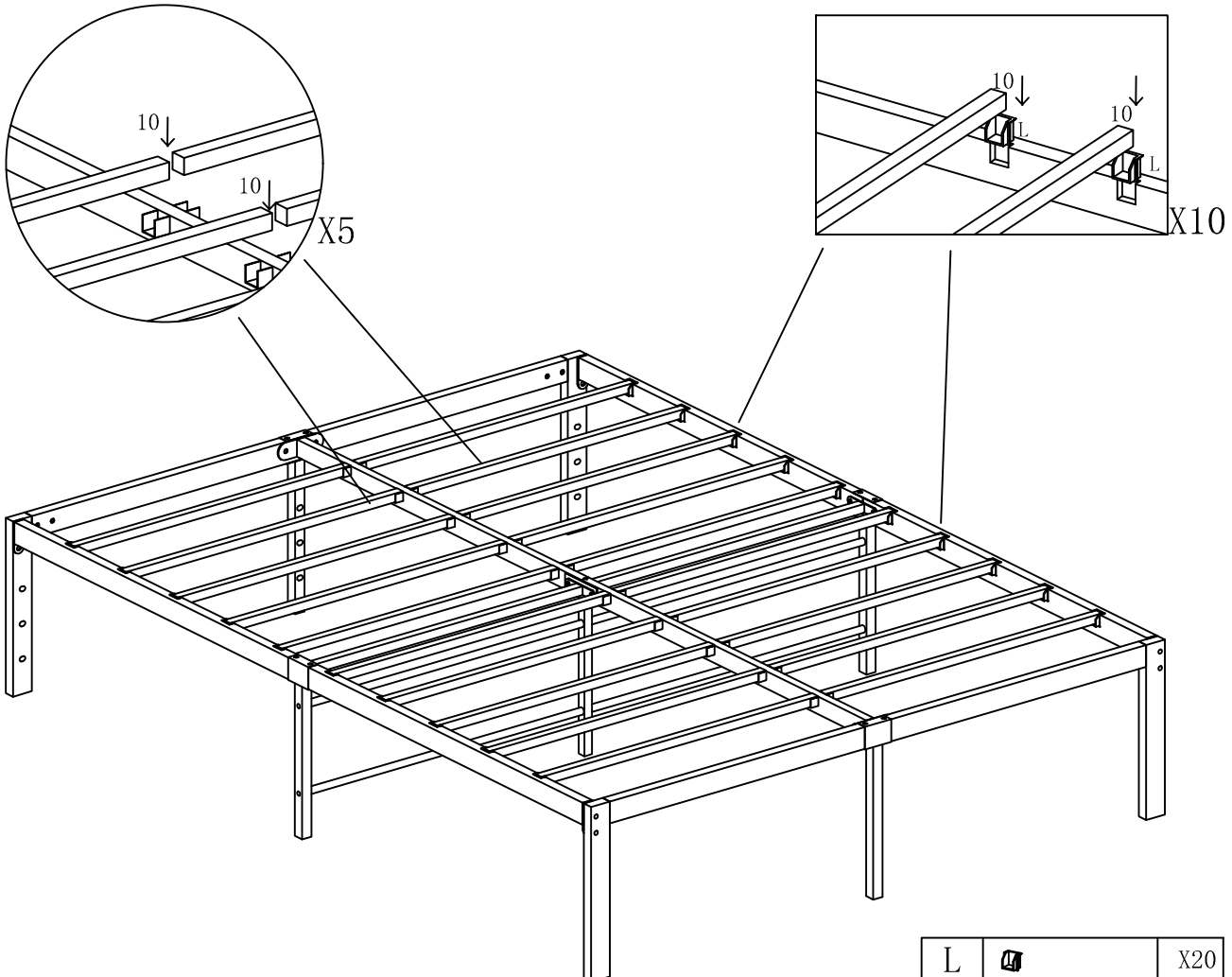

X5

X10

L			X20
---	---	--	-----