

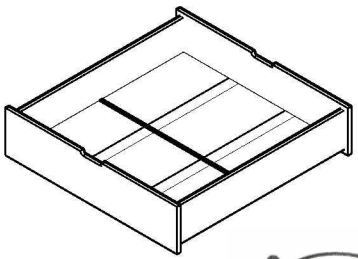

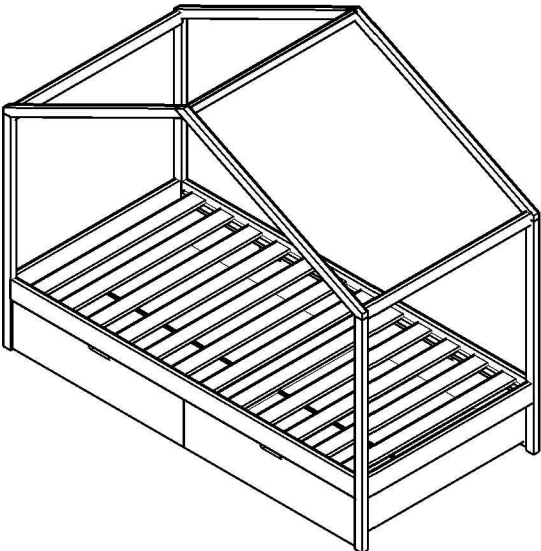



QUALIFIED CERTIFICATE  
 MODEL: BF1039 BED  
 CHECKER: 02

BF1039 DRAWER

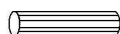
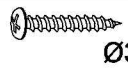

The screw will be loose in the use of the product, and the hardware screw should be re tightened every 15 days .

HARDWARE

B		16+1	P		08
C	 Ø8*30mm	24+2	O	 Ø3*15mm	16+2
I	 M6*40mm	16+1	X		02
F	 4*120mm	01			

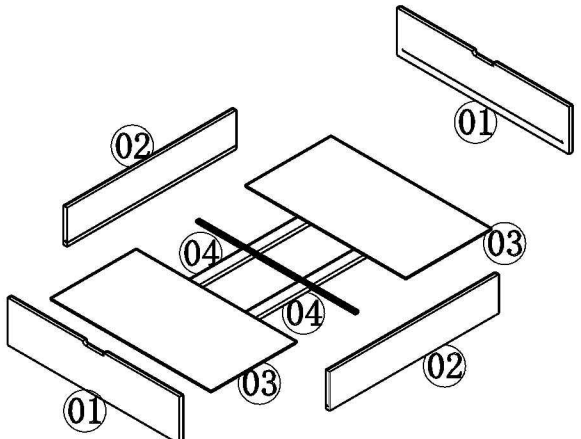

01

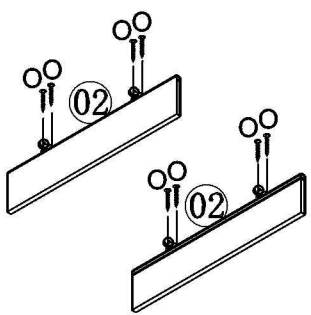

X2



x2

P		08
O	 Ø3*15mm	16

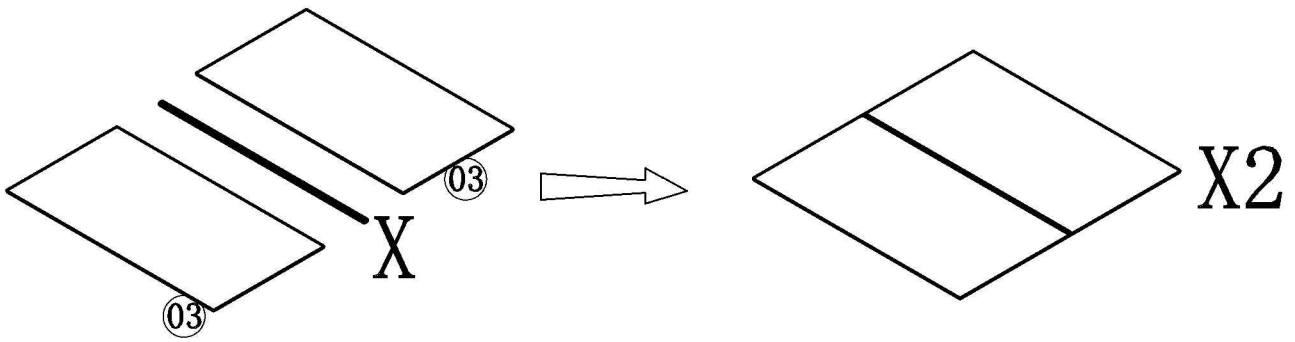

02

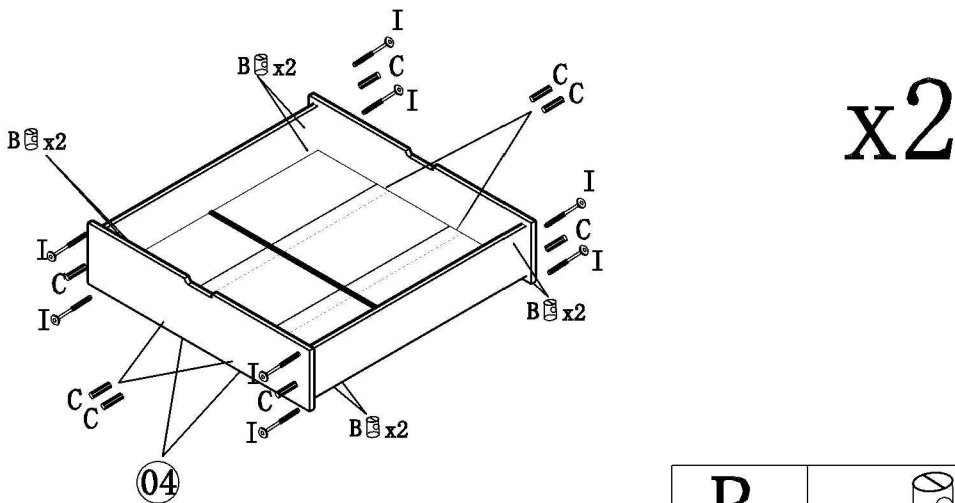

X		02
---	---	----

03



B		16
I	 15mm      M6*40mm	16
C	 ∅ 8*30mm	24