

# ASSEMBLY INSTRUCTION

## MYA STONECAST RIBBED WALL LIGHT

TEMPLE &  
WEBSTER

1

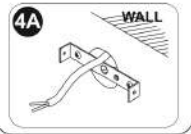
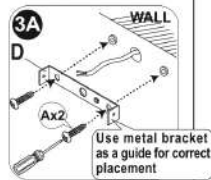
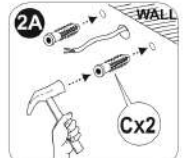
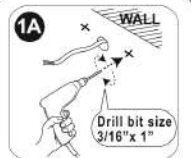

2 Remove the cap for assembly, then screw it back together

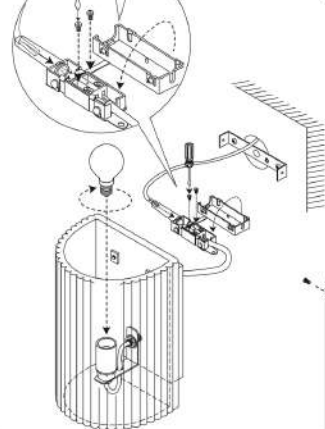

3

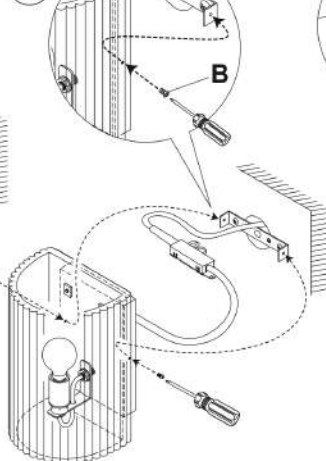

4

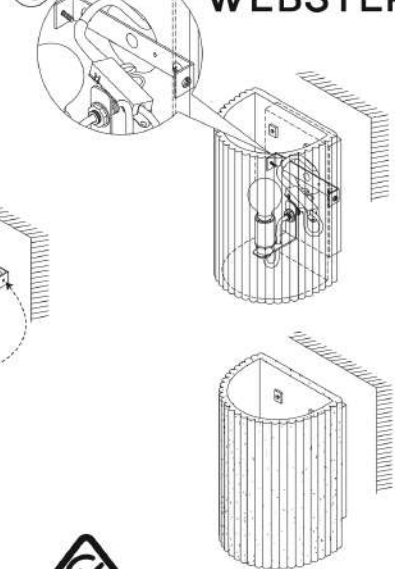

BULB NOT INCLUDED



1. Drill bit size 3/16"x1".
2. Remove the cap for assembly, then screw it back together.
3. Push the bottom to adjust the cable wire.
4. Use metal bracket as a guide for correct placement.

5. Safety:

- Check that all parts and components are in good condition, never install a product that appears to be damaged. It is strongly recommended that you use a professional trades person to install this product.
- Ensure that all electrical fittings and cables are not live during installation. Check for electrical cables or hazards before drilling in to ceiling surface. Do not install this product if any cables become damaged.
- Always choose screws and fittings that are especially suited to the wall type.



ITEM No.: PYMSCRWL  
SIZE: 16 X 14.8 X 23.5 CM H.

- ☐ MAX. 60W E27
- ☐ MAX. 11W E27

PS-F17K-TEMPLE & WEBSTER