

QNMKDCNT

Read first, enjoy forever

Assembly tips

- Assemble your product on a level surface and lay something soft underneath to protect potential floor damage.
- Don't over tighten screws. During assembly we recommend tightening to approximately 70% tightness. Only tighten hardware 100% when fully assembled.
- Keep children away from assembly area as bags and small parts can pose a choking hazard.
- Make sure you have enough space to layout parts before starting. We recommend assembling your item in its final location.
- Do not stand on or put weight on the parts as it may warp or damage product.
- We do not recommend the use of drills or power tools (unless specified) as it may damage the product or hardware. Use hand held screwdrivers only.
- It is best that two people assemble the product as some products may be too heavy for one person. Check this booklet for guidance.

Safety, care and maintenance

- To reduce the risk of injury, always secure storage furniture to walls and/or floors by using tip -over restraints.
- Never let children climb or hang on drawers, doors or shelves.
- To protect your product and your home, we recommend using coasters, placemats, rugs and other protective items.
- Screws may loosen over time. We recommend setting a reminder to tighten up every six months.
- Remove any liquid spills immediately using a clean cloth with mild detergent. Do not use bleach or abrasive cleaners. Always test any cleaning agent in an inconspicuous spot first to know if it is suitable.

Recycling

We hope that you love your product forever, but we know situations change. In the event that you wish to dispose of your product please consider some creative ways to give it a new home:

- If it's still in great shape, sell it on your favourite online marketplace!
- Give it a second life by affording it a fresh coat of paint.
- If you must dispose of it, why not donate it to your local charity or shelter for someone else to enjoy.

Please dispose of this product and packaging responsibly and recycle where possible. Scan the QR code to read more about Temple and Webster's commitment to a more sustainable future.





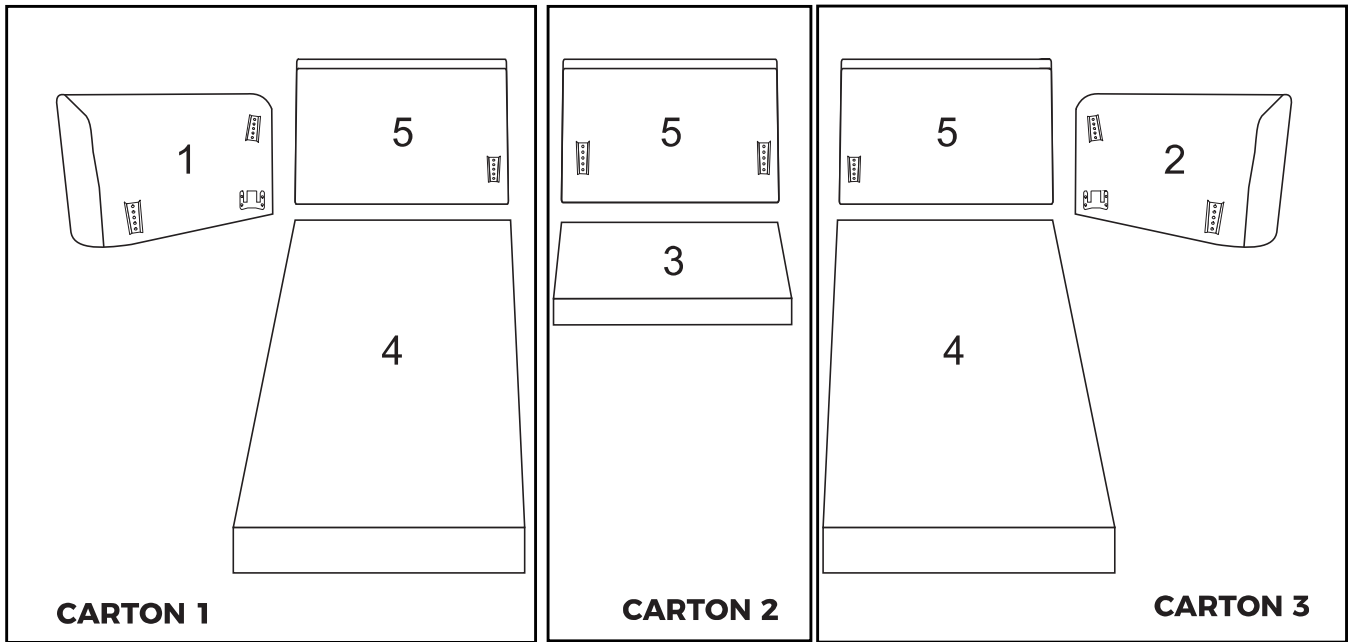

Parts list

NUMBER OF PEOPLE REQUIRED FOR ASSEMBLY:

2

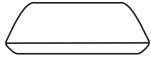
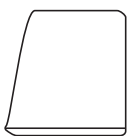

<p>A</p>  <p>14 PCS</p>	<p>B</p>  <p>14 PCS</p>	<p>C</p>  <p>9 PC</p>	<p>D</p>  <p>3 PCS</p>	<p>E</p>  <p>1 PC</p>	<p>F</p>  <p>2 PCS</p>
--	--	--	---	--	---

1.

- 1.Screw 4 pieces of Legs (A) to the bottom of the Sofa Seat (3) clockwise as shown by hand.
- 2.Glue the 4 pieces of Leg Pad (B) to the 4 pieces of Legs (A) as shown.

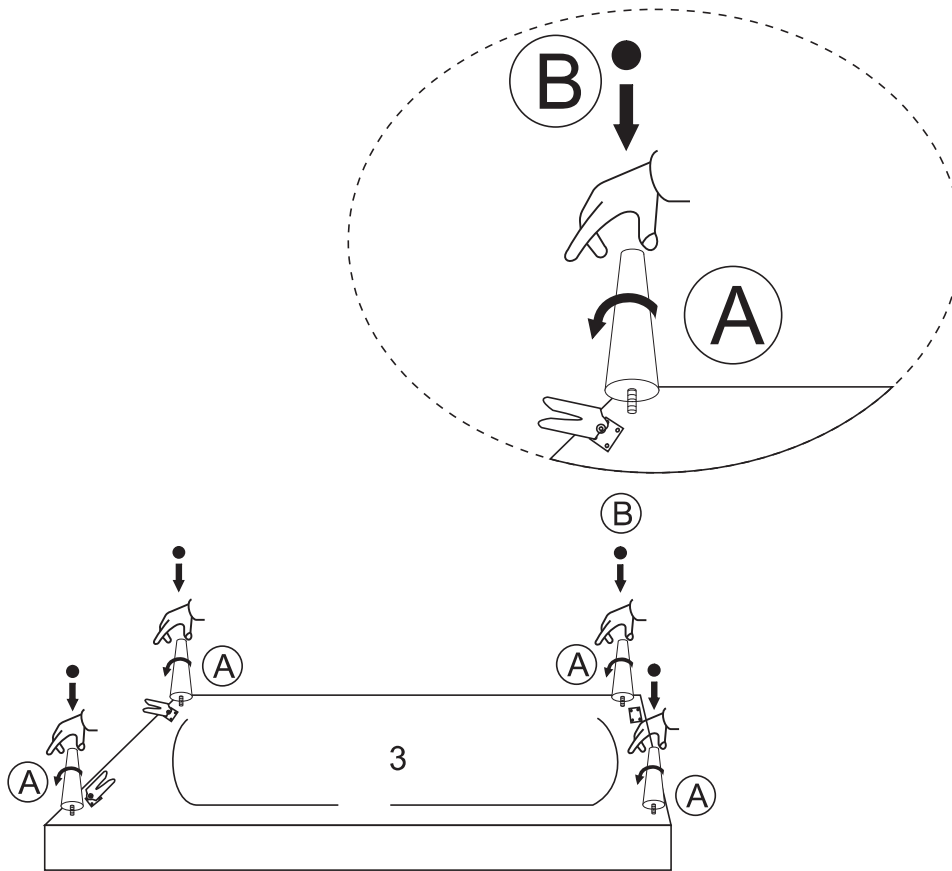

You will need:



4 PCS

LEG M8X 120MM



4 PCS

LEG PAD 3MM

2.

1. Insert Sofa Back (5) to Sofa Seat (3) by using the pre-installed Clips on Sofa Back (5) to lock each other as shown.
Note that both sides of the Sofa Back should be inserted at the same time.

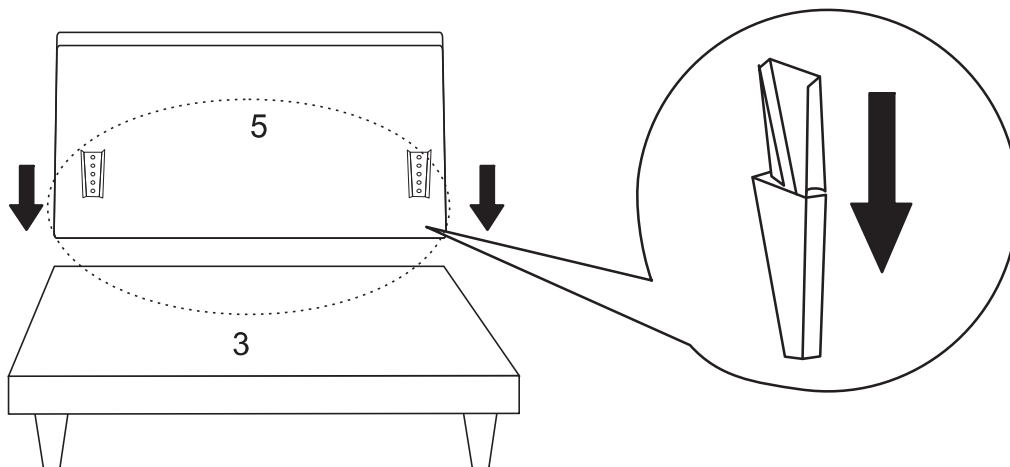

3.

1. Tear off the Velcro protective strip of cover and put on the cloth cover
2. Straighten out the cloth cover.

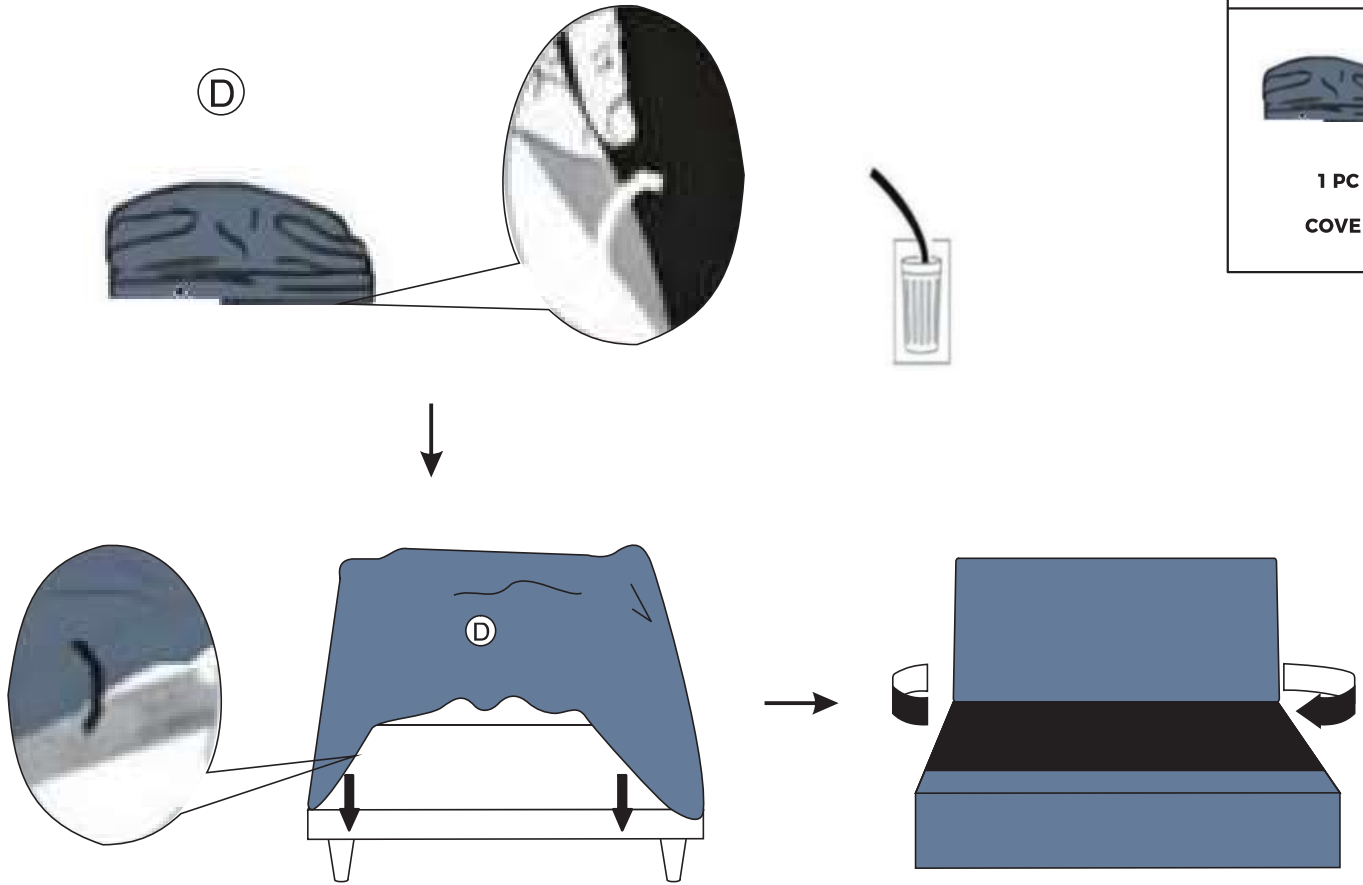

You will need:



**1 PC
COVER**

4.

1. Screw 6 pieces of Legs (A) to the bottom of the 2 pieces of Sofa Seat (3) clockwise as shown by hand.
2. Glue the 6 pieces of Leg Pad (B) to the 6 pieces of Legs (A) as shown.

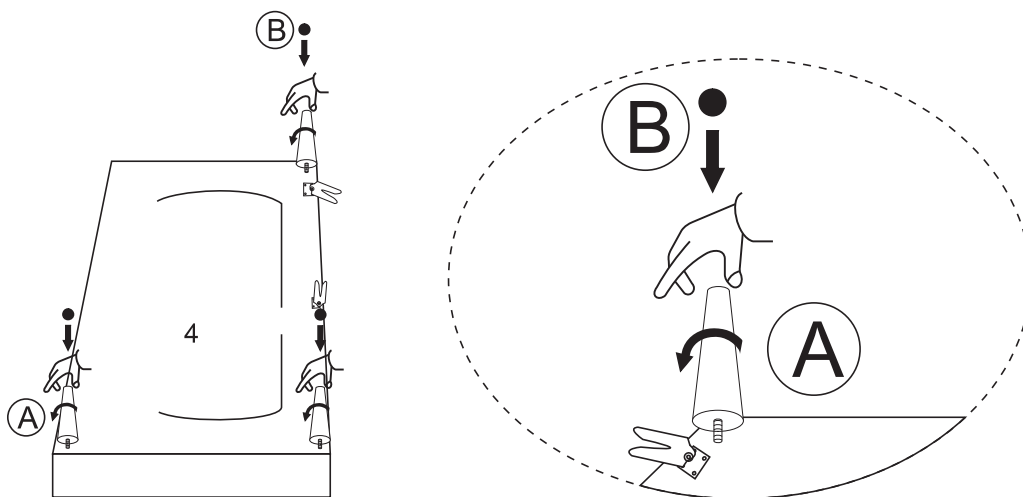

You will need:



**6 PCS
LEG M8X 120MM**



**6 PCS
LEG PAD 3MM**

**TEMPLE &
WEBSTER**

Damaged or missing parts? Or just need help?
Contact us on service@templeandwebster.com.au

5.

- 1.Screw 4 pieces of Legs (A) to the bottom of the Left Arm (1) and Right Arm (2) clockwise as shown by hand.
- 2.The armrests are installed on one side and then on the other.
- 3.Glue the 4 pieces of Leg Pad (B) to the 4 pieces of Legs (A) as shown.

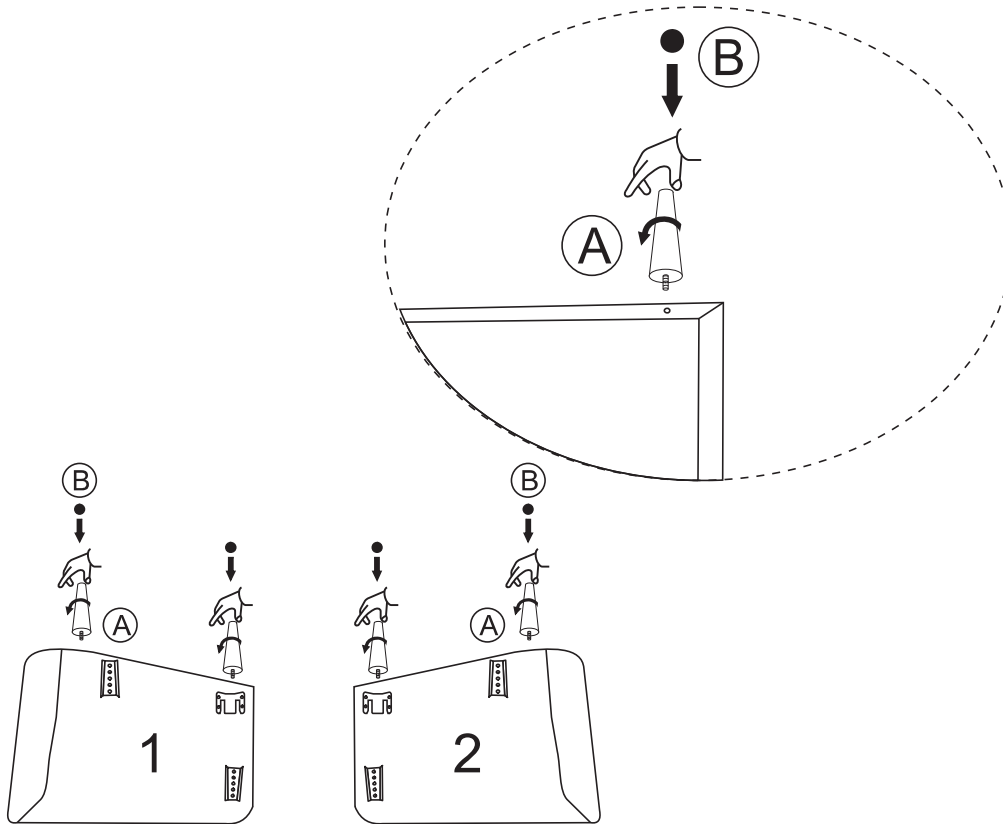

You will need:



4 PCS

LEG M8X 120MM



4 PCS

LEG PAD 3MM

6.

- 1.Insert Left Arm (1) to Sofa Seat (4) by using the pre-installed Clips to lock each other as shown.
 - 2.Insert Right Arm (2) to Sofa Seat (4) by using the pre-installed Clips lock each other as shown.
- Note that the arm should be tilted as shown in the picture and then interlocked.

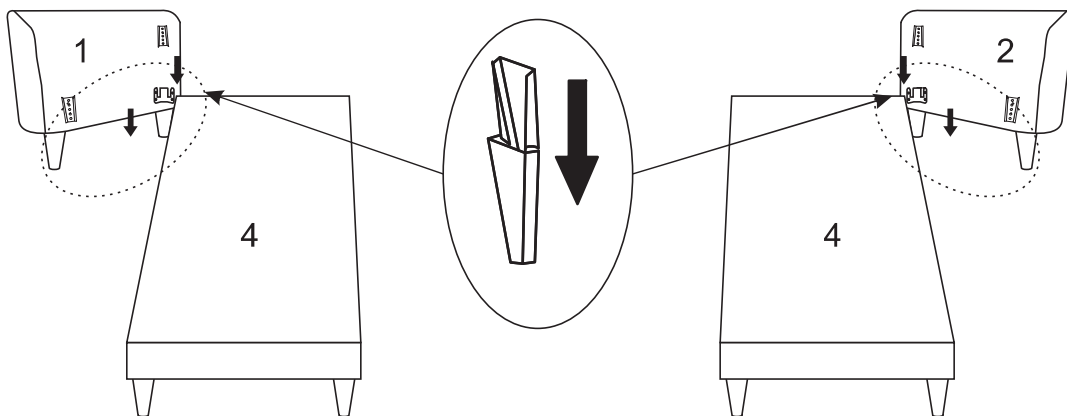

7.

1. Insert Sofa Back (5) to Sofa Seat (4) by using the pre-installed Clips on Sofa Back (5) to lock each other as shown.

Note that both sides of the Sofa Back should be inserted at the same time.

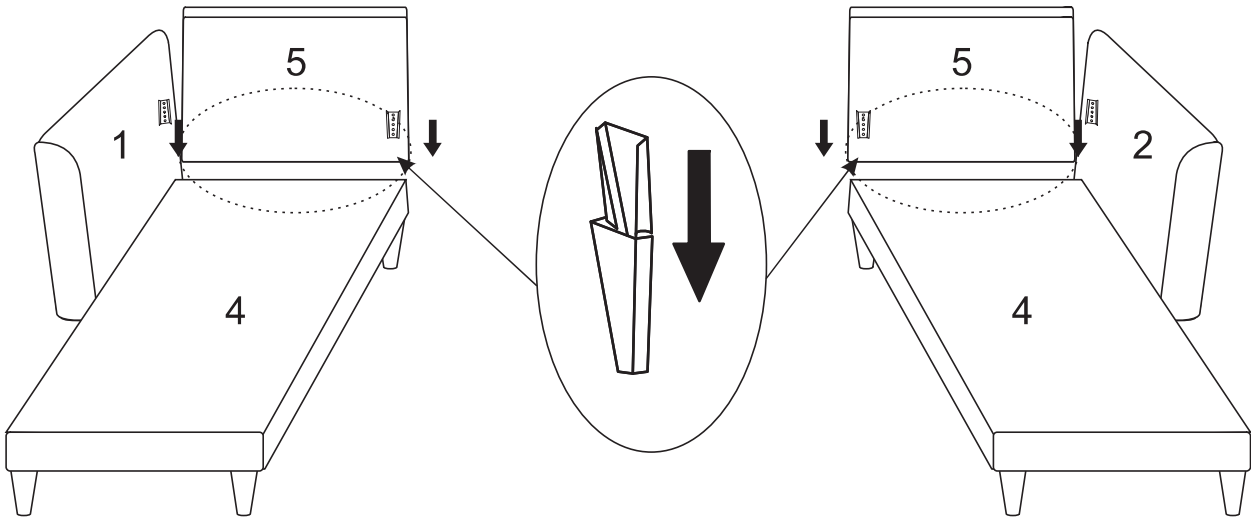

8.

1. Tear off the Velcro protective strip of cover and put on the cloth cover.
2. Straighten out the cloth cover.

You will need:



**1 PC
COVER**

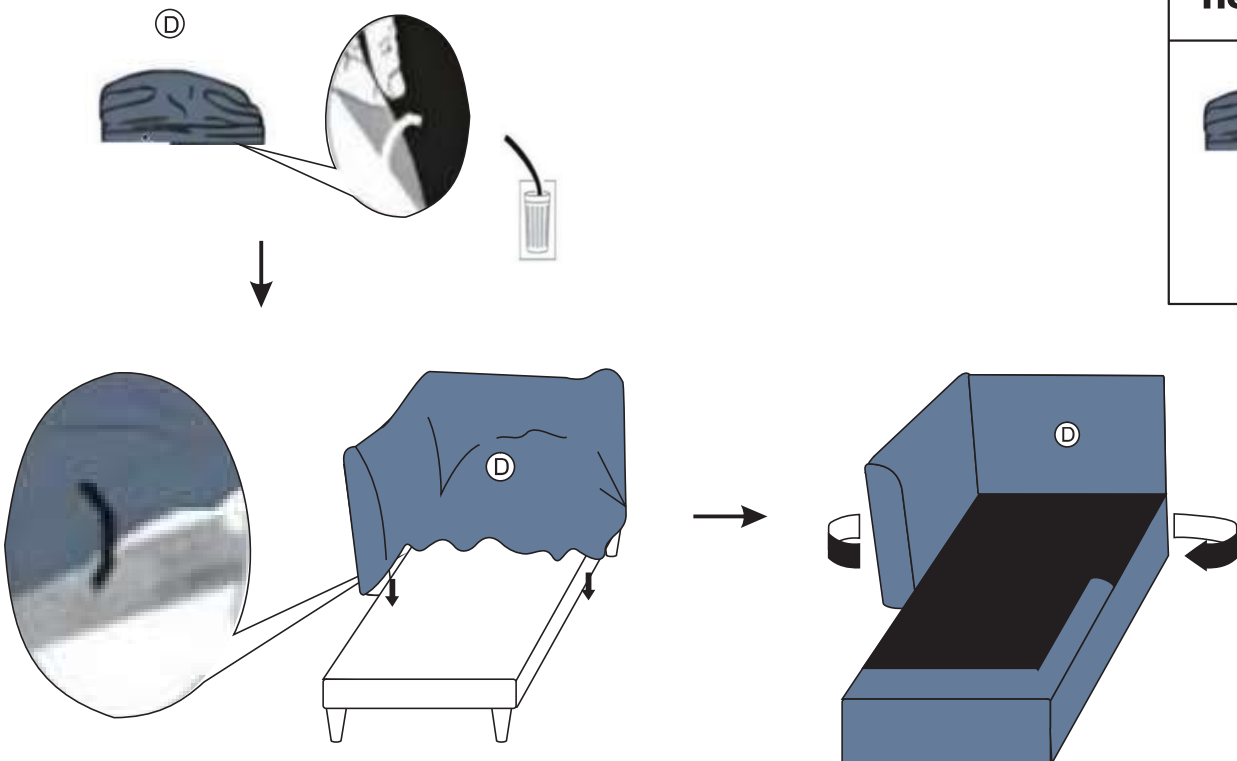

9.

1. Attach 2 pieces of Sofa Seat (4) and Sofa Seat (3) interlocked.

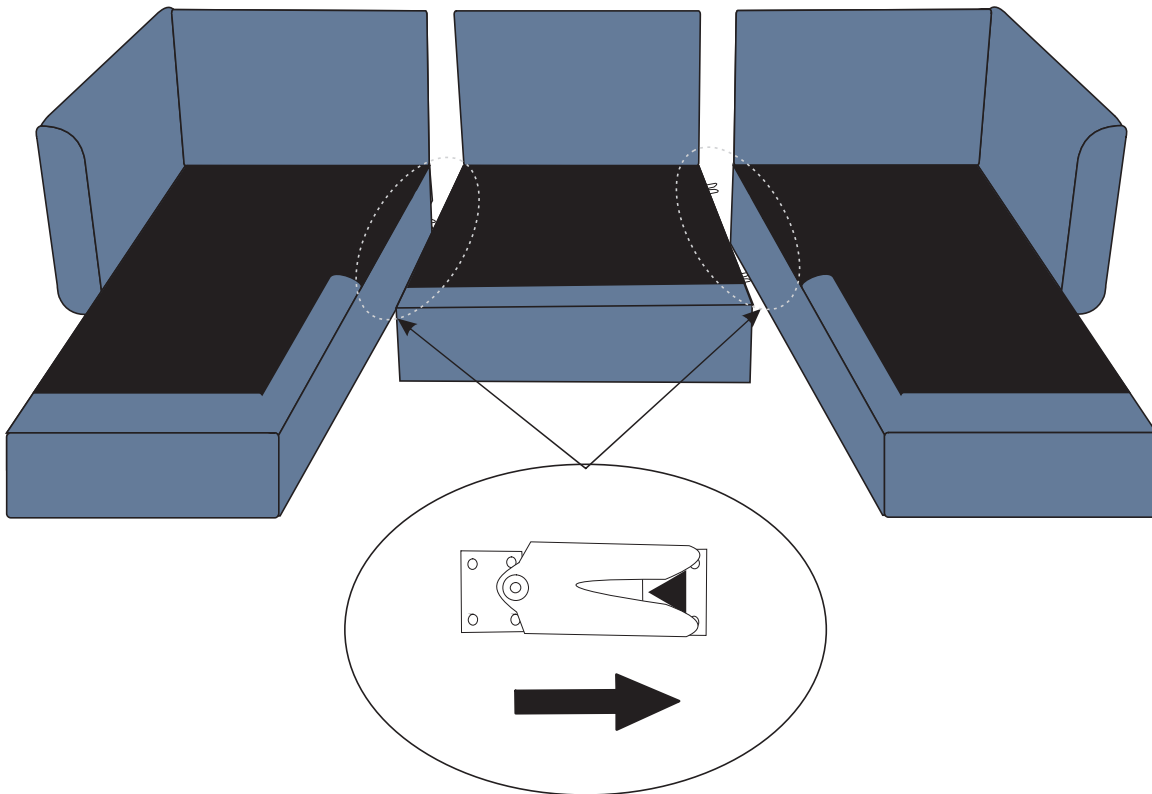

10.

1. Carefully put 2 pieces of Seat Cushion (F) and Seat Cushion (E) to the assembled 2 pieces of Sofa Seat (4) and Sofa Seat (3) as shown.

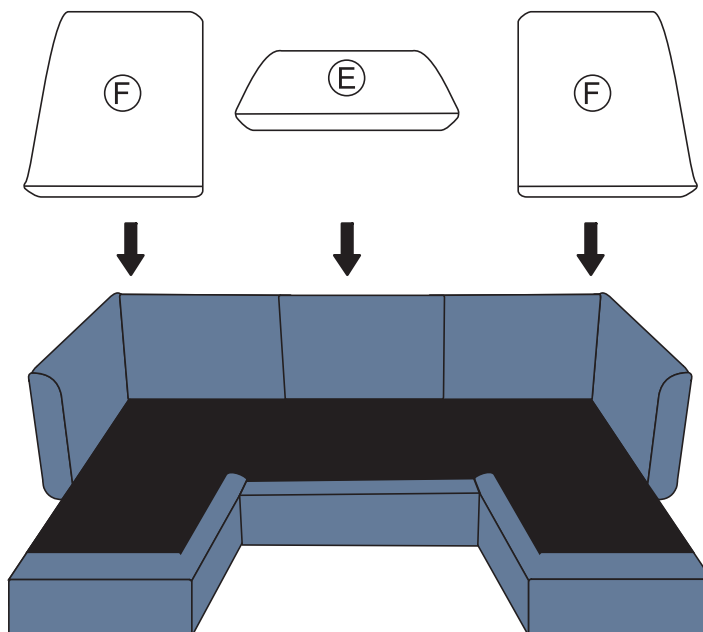

You will need:

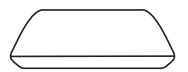

1 PC

Seat Cushion

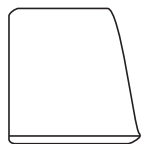

2 PCS

Seat Cushion

11.

1. Carefully put 9 pieces of Back Cushion (C) to the assembled Sofa (5) as shown.

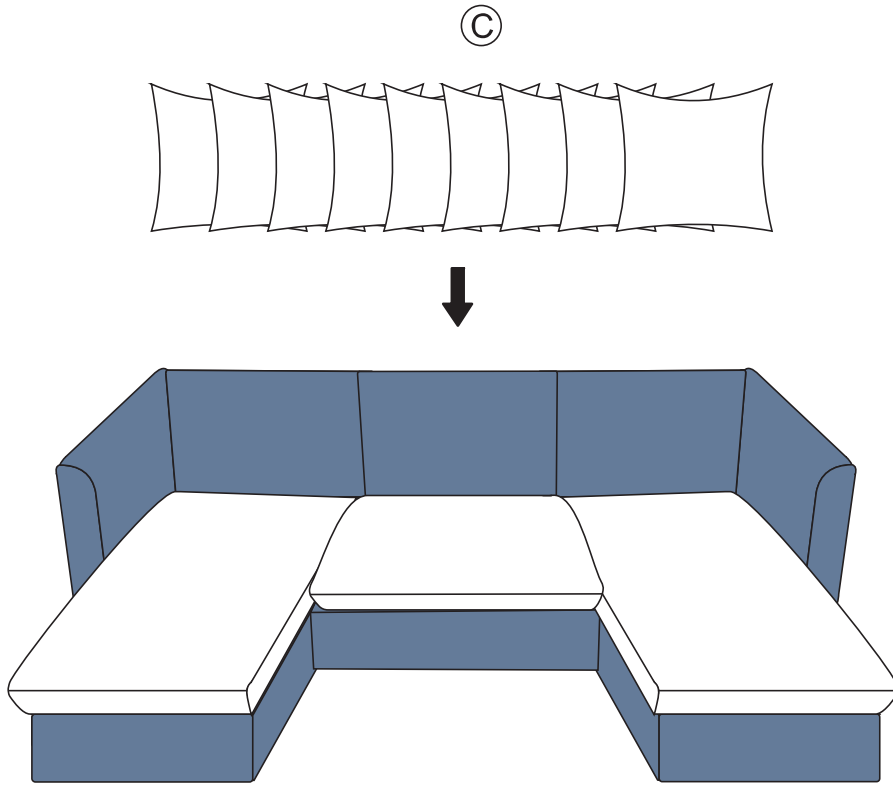

You will need:

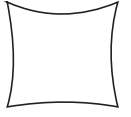

9 PCS

Back Cushion