

Assembly Instruction
5-Tier Corner Bookcase
IHD-BS12-FB

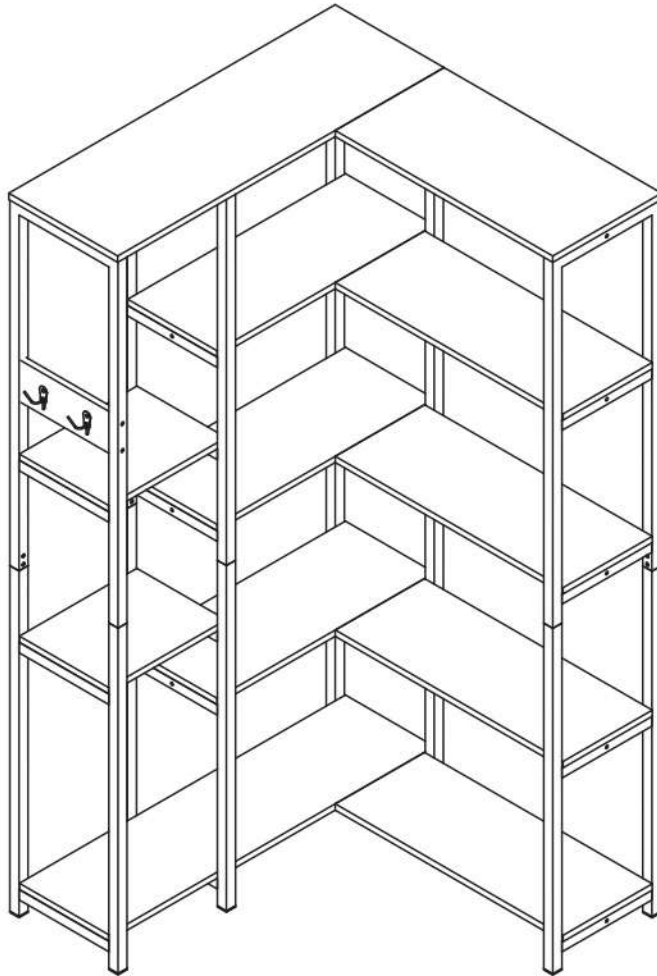





Before Assembly

IMPORTANT NOTE:

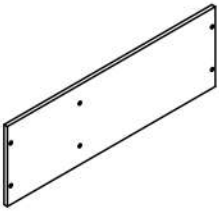
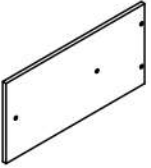

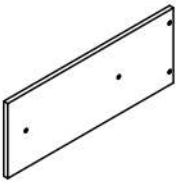
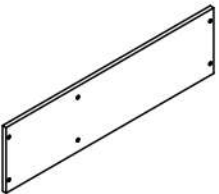
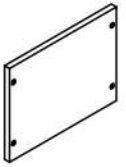

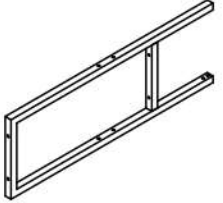
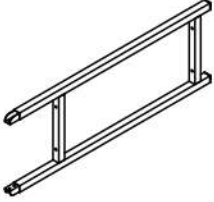
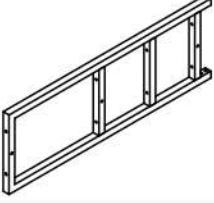
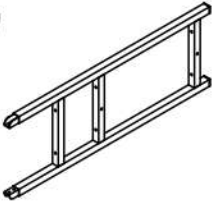
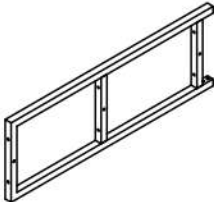
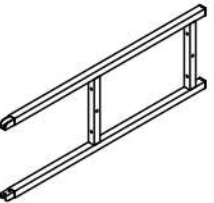
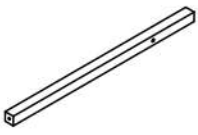
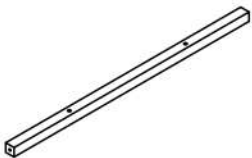



- Make sure all parts and hardware are included and free of obvious Defect before disposing of any packaging.
- Place all wooden parts on a clean and smooth surface such as a rug or carpet to avoid the parts from being scratched.
- DO NOT tighten all screws and bolts until completely assembled.
- Assembly will require two people.

PART LIST

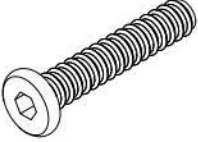
			
1 PC	1 PC	3 PCS	4 PCS
			
1 PC	2 PCS	1 PC	1 PC
			
1 PC	1 PC	1 PC	2 PCS
			
2 PCS	5 PCS	5 PCS	

Before Assembly

HARDWARE LIST

A  M6x10mm	B  M6x35mm	C  M6x45mm	D  M7x50mm
16 PCS	52 PCS	20 PCS	4 PCS
E  M3.5x12mm	F  2 PCS	H  1 PC	
4 PCS	2 PCS	1 PC	
I  M4x35mm			
2 PCS			

Before Assembly

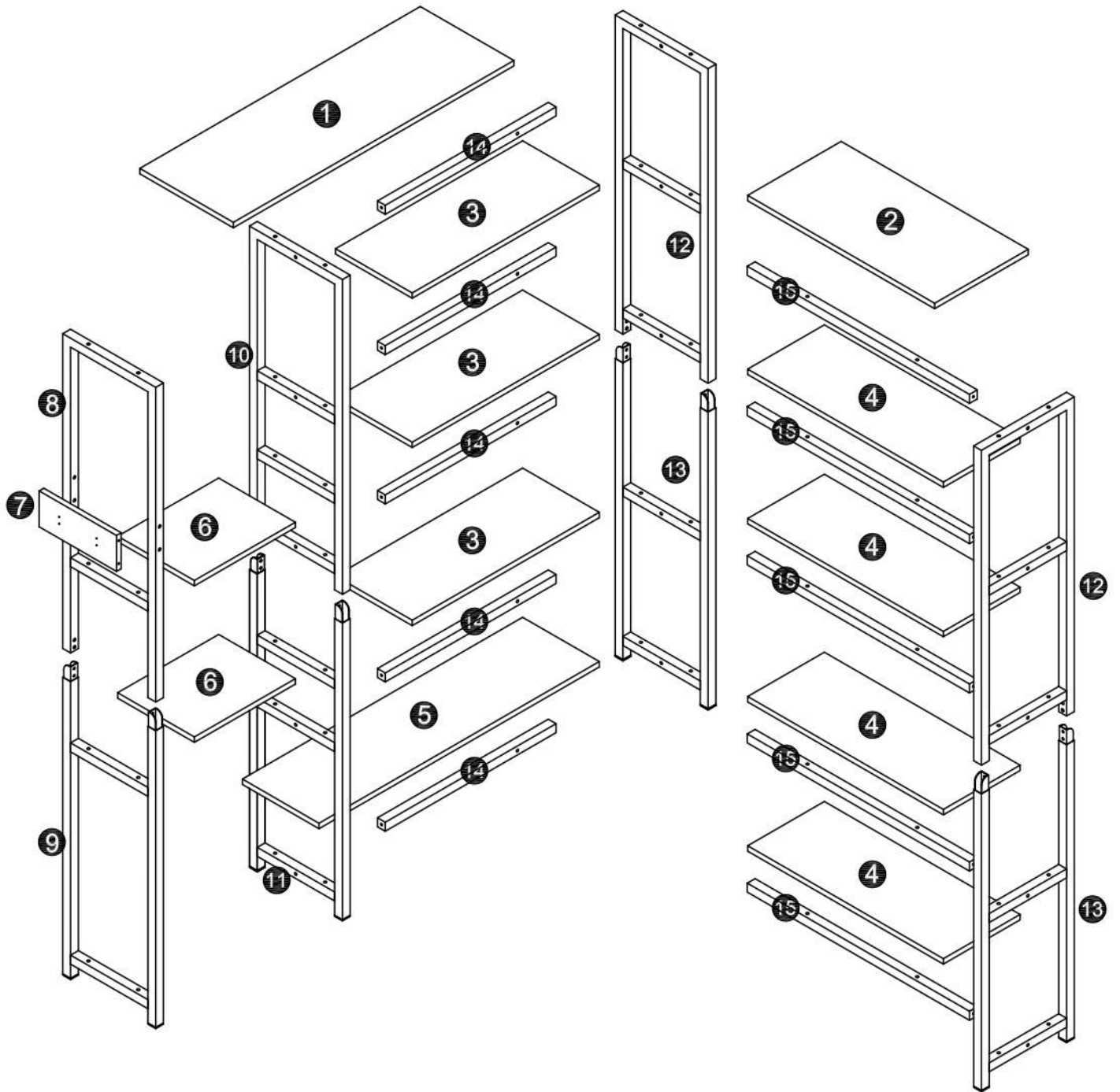

NOTED:

Do not fully tighten all bolts until all parts are in place. Failure to follow these instructions may cause the bolt to misalign during assembly.

Step 1

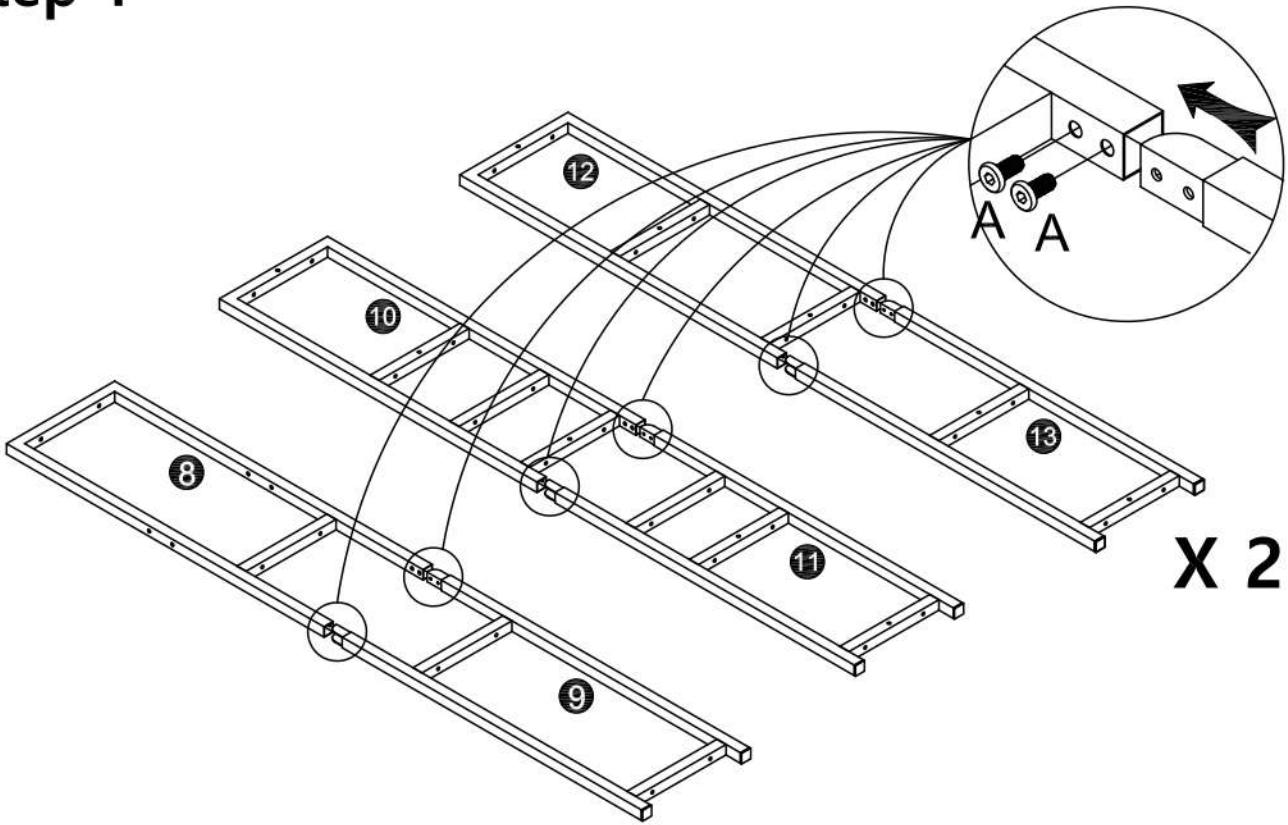

A x 16 PCS

Step 2

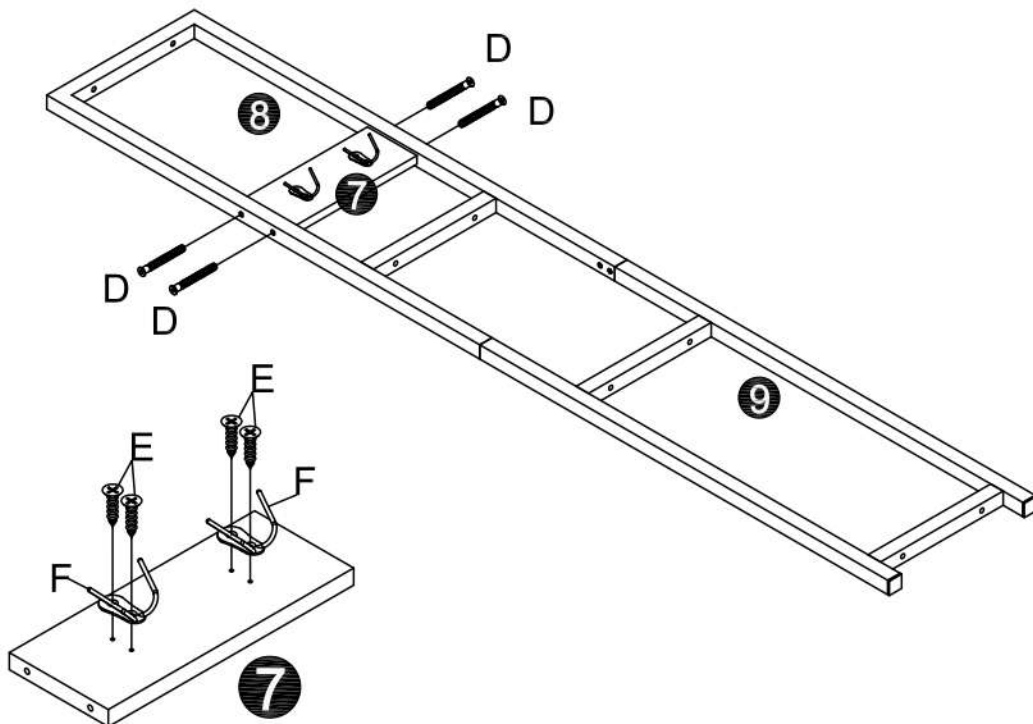

D x 4 PCS

E x 4 PCS

F x 2 PCS

NOTED:

Do not fully tighten all bolts until all parts are in place. Failure to follow these instructions may cause the bolt to misalign during assembly.

Step 3

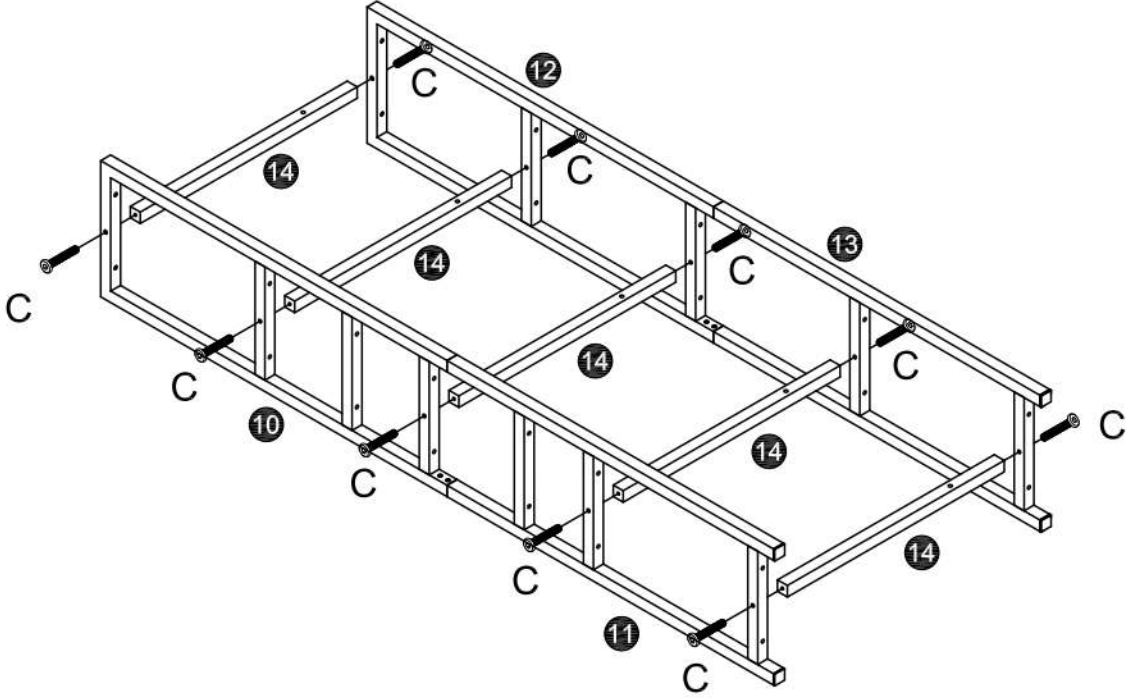

C x 10 PCS

Step 4

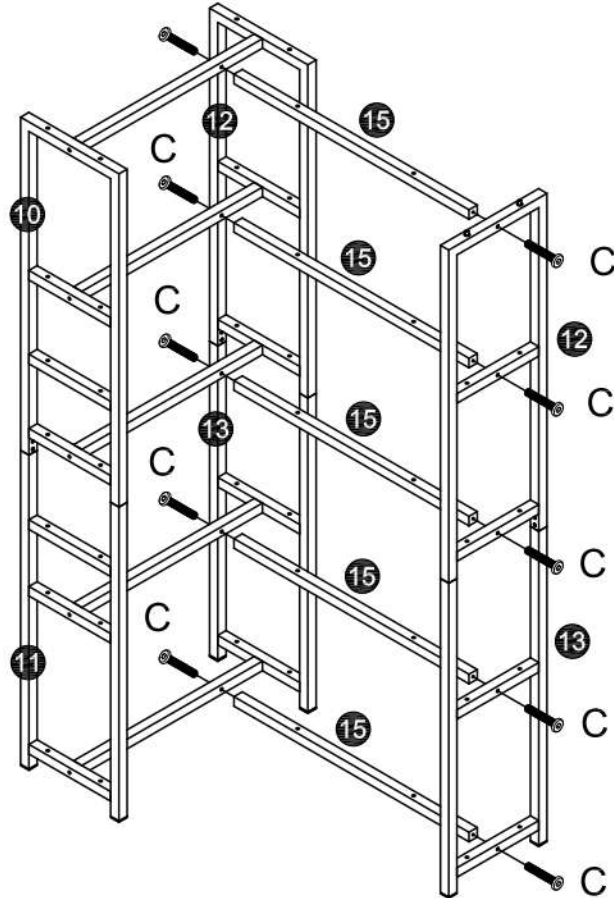

C x 10 PCS

NOTED:

Do not fully tighten all bolts until all parts are in place. Failure to follow these instructions may cause the bolt to misalign during assembly.

Step 5

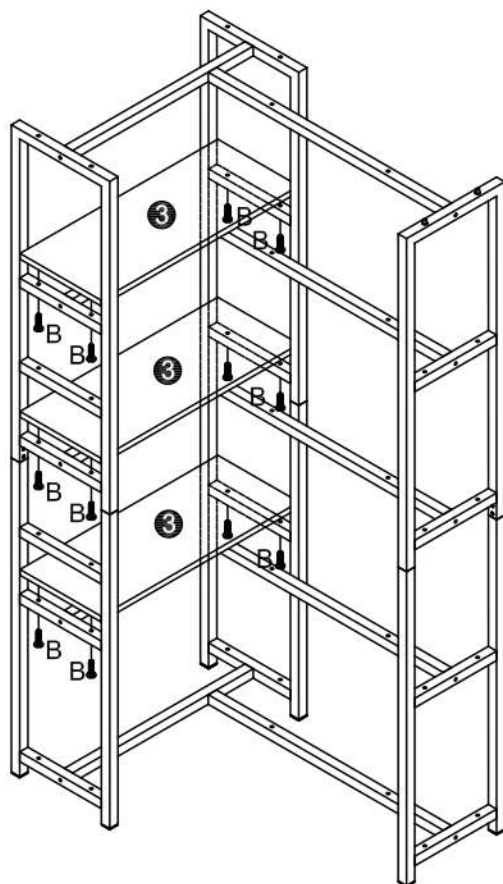

B x 12 PCS

Step 6

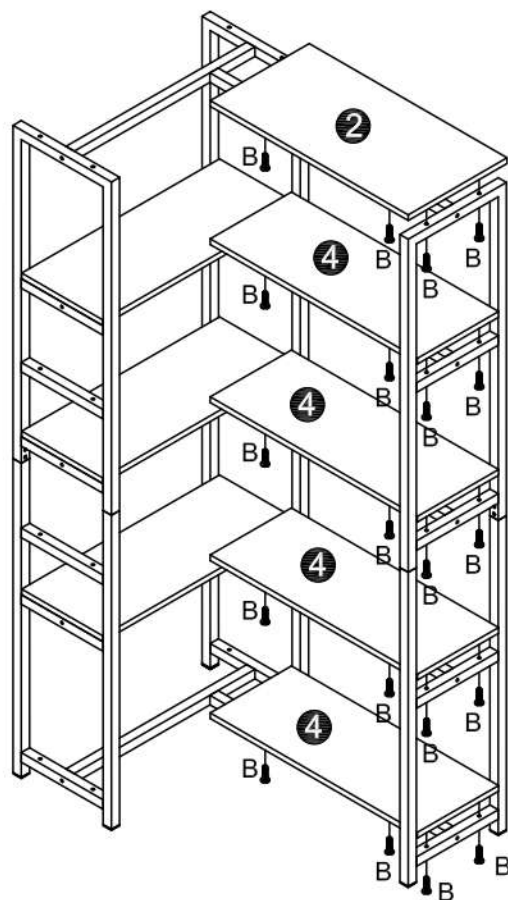

B x 20 PCS

NOTED:

Do not fully tighten all bolts until all parts are in place. Failure to follow these instructions may cause the bolt to misalign during assembly.

Step 7

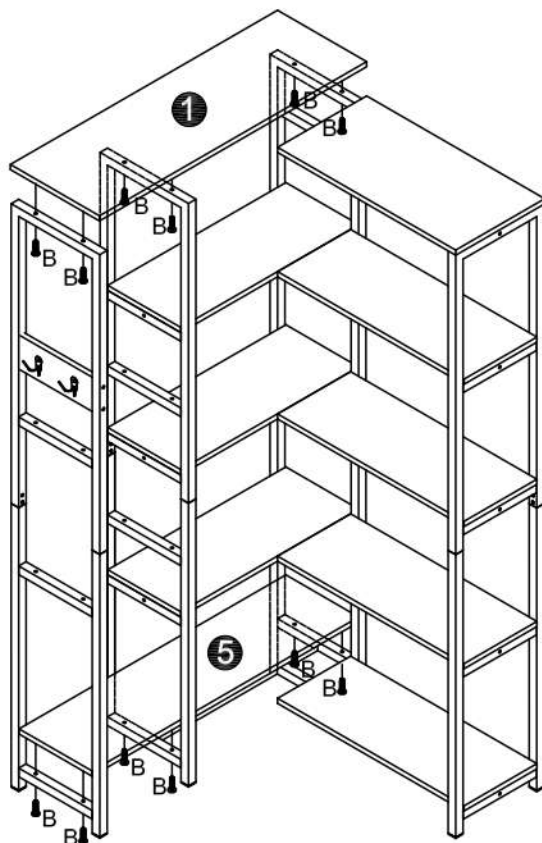

B x 12 PCS

Step 8

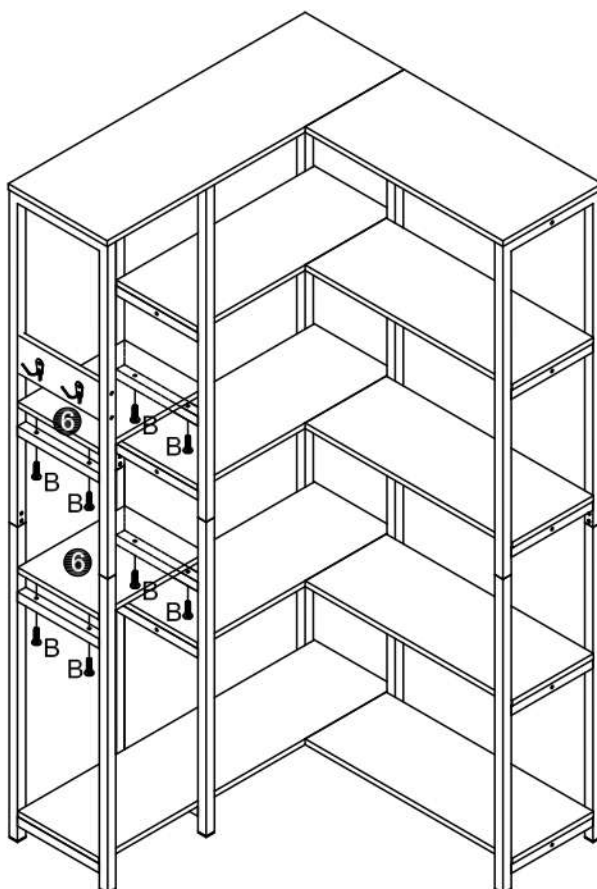

B x 8 PCS

NOTED:

Do not fully tighten all bolts until all parts are in place. Failure to follow these instructions may cause the bolt to misalign during assembly.

Step 9

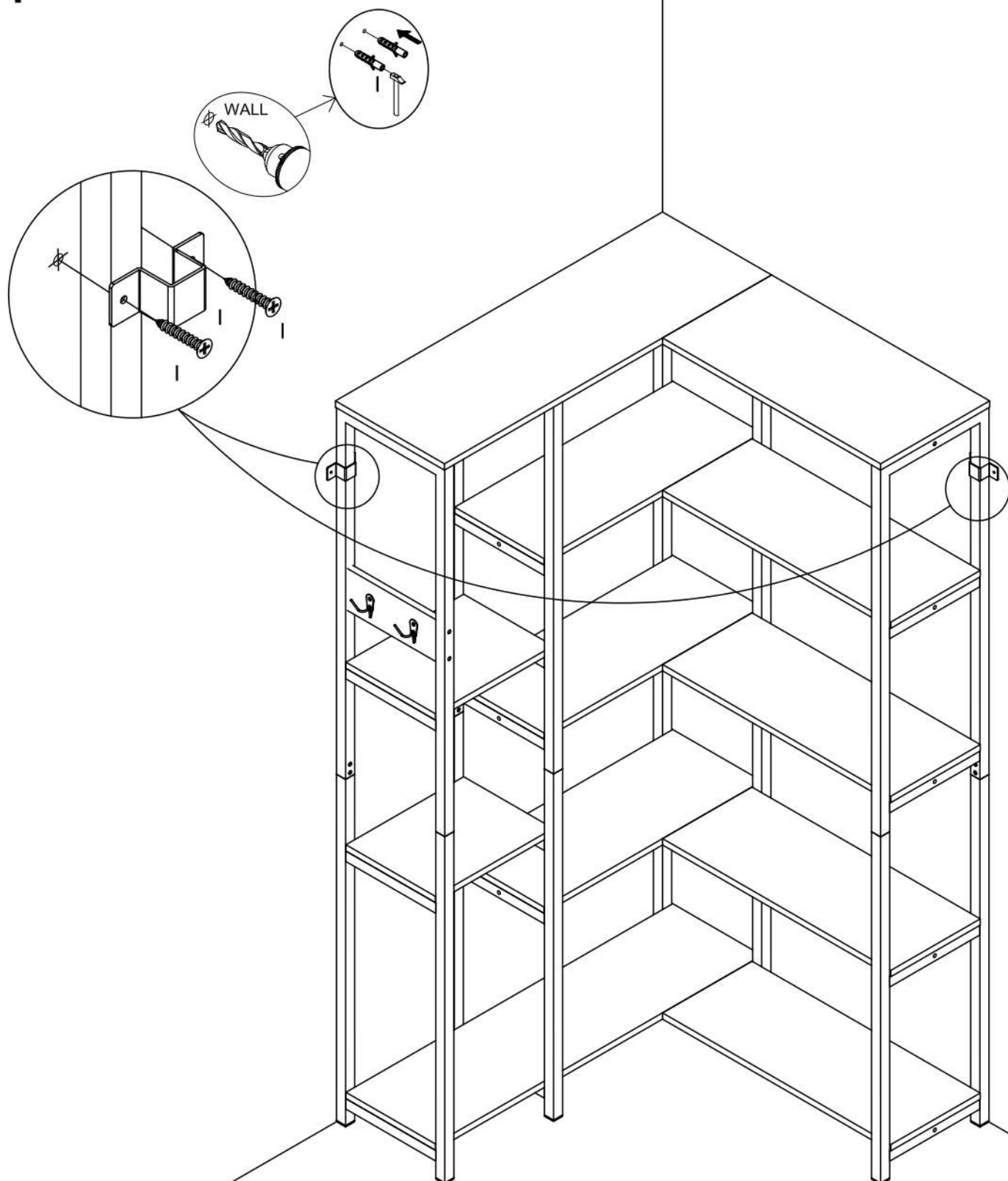

1 x 2 PCS