

## ASSEMBLY INSTRUCTIONS GLCBCN

Read these instructions and follow steps carefully to ensure you assemble the product correctly and avoid damages. Check that all parts and hardware have been provided before assembling the product. Place all contents on a clean, soft-flat surface to avoid scratching the product.

**CAUTION:**

Only tighten bolts to 80% at first. Once all parts have been assembled, fully tighten all hardware.

To prevent damage to threads, do not use a power tool and do not overtighten bolts.







Use two people to lift and turn the product when assembling.

Do not attempt with only one person and do not roll onto legs.

Keep all hardware and small parts away from children.

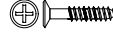

PART LIST		
ITEM	DESCRIPTION	QTY
A	LEG	1PC
B	BASE	1PC
C	FRAME LEG 1	1PC
D	FRAME LEG 2	1PC
E	BACK CUSHION 1	1PC
F	BACK CUSHION 2	1PC
G	BASE CUSHION	1PC

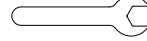
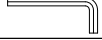
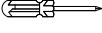
HARDWARE LIST		
ITEM	DESCRIPTION	QTY
1	BOLT M6X120 	2PCS
2	BOLT M6X55 	1PC
3	BOLT M6X55 	3PCS
4	WASHERS 	2PCS
5	LOCK NUT 	2PCS
6	SCREW M4X15 	16PCS
7	BRACKET 	4PCS
8	KEY 	1PC
9	ALLEN KEY 	2PCS
10	SCREWDRIVER 	1PC

**STEP 1:** Attach leg (A) to base (B). Install washers (4) and lock nuts (5) on each bolt of the legs as shown below. Use wrench (8) to secure.

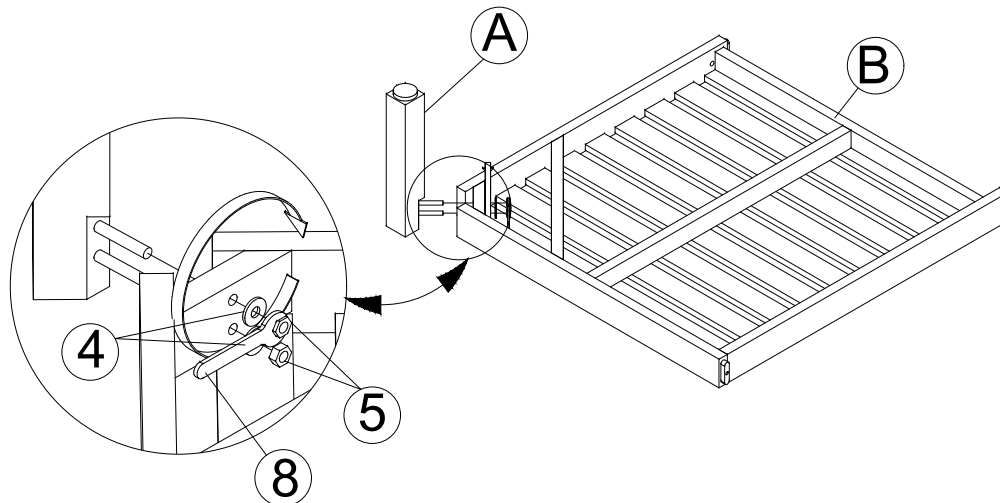

**STEP 2:** Attach frame leg 1 (C) to base (B). Insert nut (1) & nut (2) into base (B). Then insert bolt (1) & bolt (2) through frame leg 1 (C) into base (B) as shown below. Tighten with allen key (9).

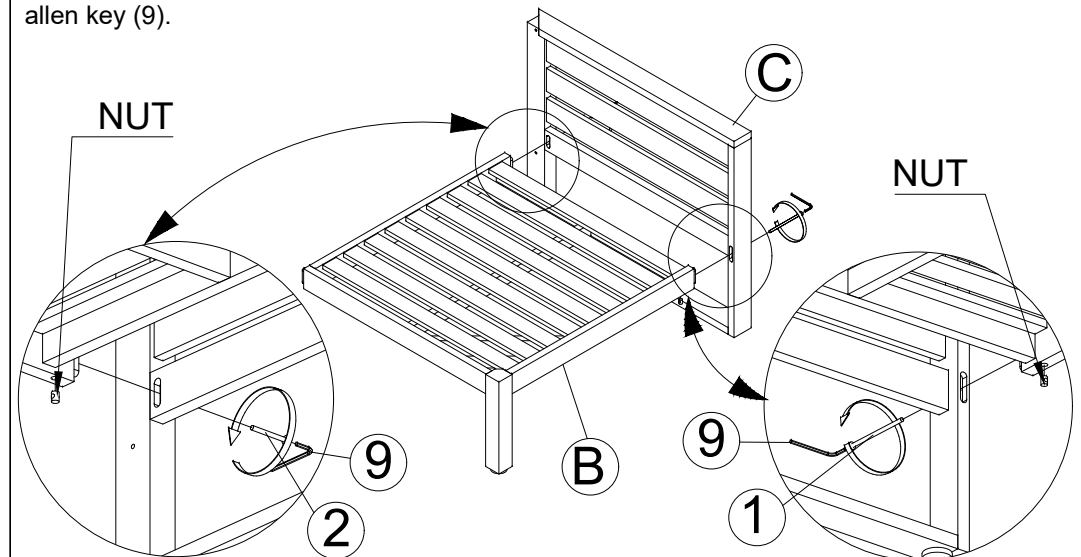

## ASSEMBLY INSTRUCTIONS GLCBCN

Read these instructions and follow steps carefully to ensure you assemble the product correctly and avoid damages. Check that all parts and hardware have been provided before assembling the product. Place all contents on a clean, soft-flat surface to avoid scratching the product.

**⚠ CAUTION:**

Only tighten bolts to 80% at first. Once all parts have been assembled, fully tighten all hardware.

To prevent damage to threads, do not use a power tool and do not overtighten bolts.







Use two people to lift and turn the product when assembling.

Do not attempt with only one person and do not roll onto legs.

Keep all hardware and small parts away from children.

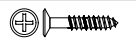

PART LIST		
ITEM	DESCRIPTION	QTY
A	LEG	1PC
B	BASE	1PC
C	FRAME LEG 1	1PC
D	FRAME LEG 2	1PC
E	BACK CUSHION 1	1PC
F	BACK CUSHION 2	1PC
G	BASE CUSHION	1PC

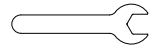
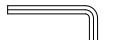
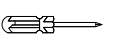
HARDWARE LIST		
ITEM	DESCRIPTION	QTY
1	BOLT M6X120 	2PCS
2	BOLT M6X55 	1PC
3	BOLT M6X55 	3PCS
4	WASHERS 	2PCS
5	LOCK NUT 	2PCS
6	SCREW M4X15 	16PCS
7	BRACKET 	4PCS
8	KEY 	1PC
9	ALLEN KEY 	2PCS
10	SCREWDRIVER 	1PC

**STEP 3:** Attach frame leg 2 (D) to base (B) & frame leg 1(C). Insert nut (1) into base (B). Then insert bolt (1) through frame leg 2 (D) into base (B) as shown below. Tighten with allen key (9).

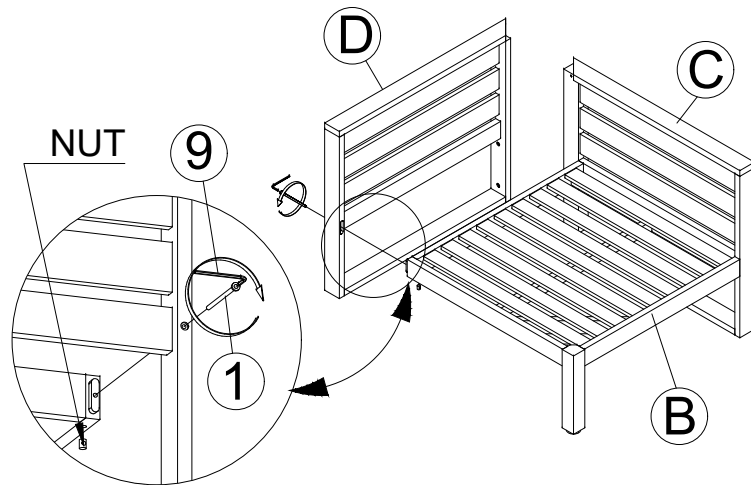

**STEP 4:** Insert caps (3) into frame leg 2 (D). Then insert bolt (3) through frame leg 1 (C) into frame leg 2 (D) as shown below. Tighten with allen key (9).

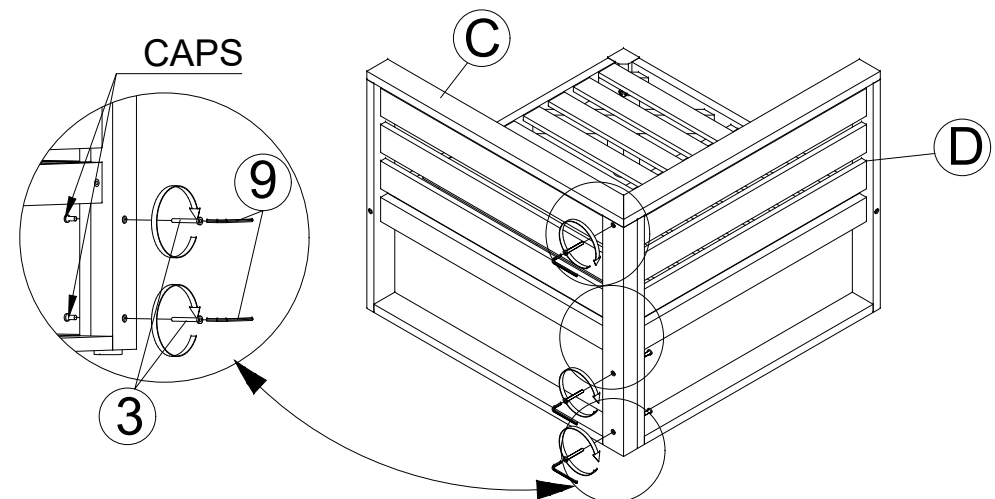

## ASSEMBLY INSTRUCTIONS GLCBCN

Read these instructions and follow steps carefully to ensure you assemble the product correctly and avoid damages. Check that all parts and hardware have been provided before assembling the product. Place all contents on a clean, soft-flat surface to avoid scratching the product.

**⚠ CAUTION:**

Only tighten bolts to 80% at first. Once all parts have been assembled, fully tighten all hardware.

To prevent damage to threads, do not use a power tool and do not overtighten bolts.









Use two people to lift and turn the product when assembling.

Do not attempt with only one person and do not roll onto legs.

Keep all hardware and small parts away from children.

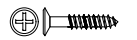

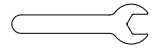
PART LIST		
ITEM	DESCRIPTION	QTY
<b>A</b>	LEG	1PC
<b>B</b>	BASE	1PC
<b>C</b>	FRAME LEG 1	1PC
<b>D</b>	FRAME LEG 2	1PC
<b>E</b>	BACK CUSHION 1	1PC
<b>F</b>	BACK CUSHION 2	1PC
<b>G</b>	BASE CUSHION	1PC

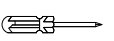
HARDWARE LIST		
ITEM	DESCRIPTION	QTY
<b>1</b>	BOLT M6X120 	2PCS
<b>2</b>	BOLT M6X55 	1PC
<b>3</b>	BOLT M6X55 	3PCS
<b>4</b>	WASHERS 	2PCS
<b>5</b>	LOCK NUT 	2PCS
<b>6</b>	SCREW M4X15 	16PCS
<b>7</b>	BRACKET 	4PCS
<b>8</b>	KEY 	1PC
<b>9</b>	ALLEN KEY 	2PCS
<b>10</b>	SCREWDRIVER 	1PC

**STEP 5:** Insert bracket (7) into frame leg 1 (C), frame leg 2(D) & base (C). Then insert screws (6) through bracket (7) into frame leg 1 (C), frame leg 2(D) & base (C) as shown below. Tighten with screwdriver (10).

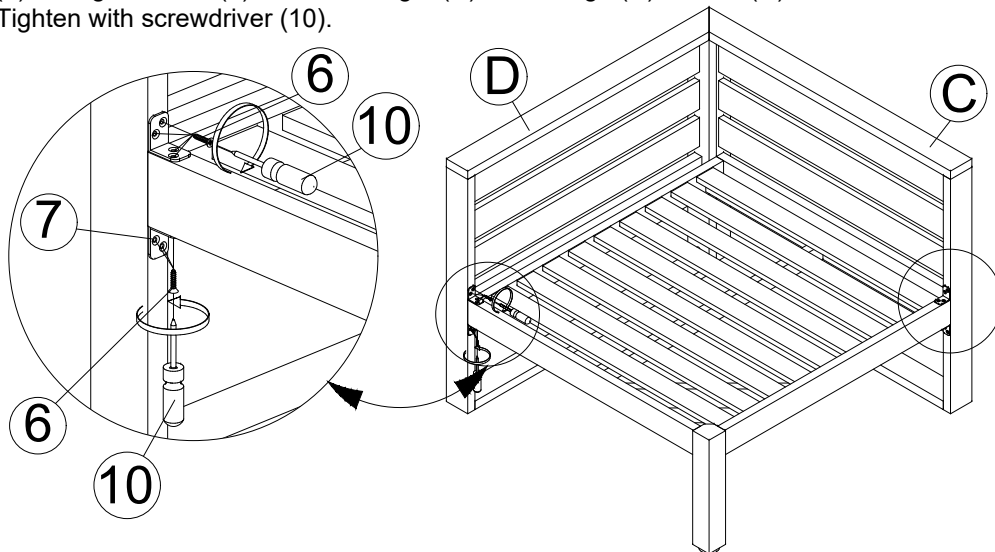

**STEP 6:** Place the assembled chair upright on a level surface. Ensure all chair legs are aligned & level, then fully tighten all bolts & screw using allen key (7). Your chair is now ready for use.

