

ASSEMBLY INSTRUCTION

CAPRI TERRACOTTA WALL SCONCE

TEMPLE &
WEBSTER

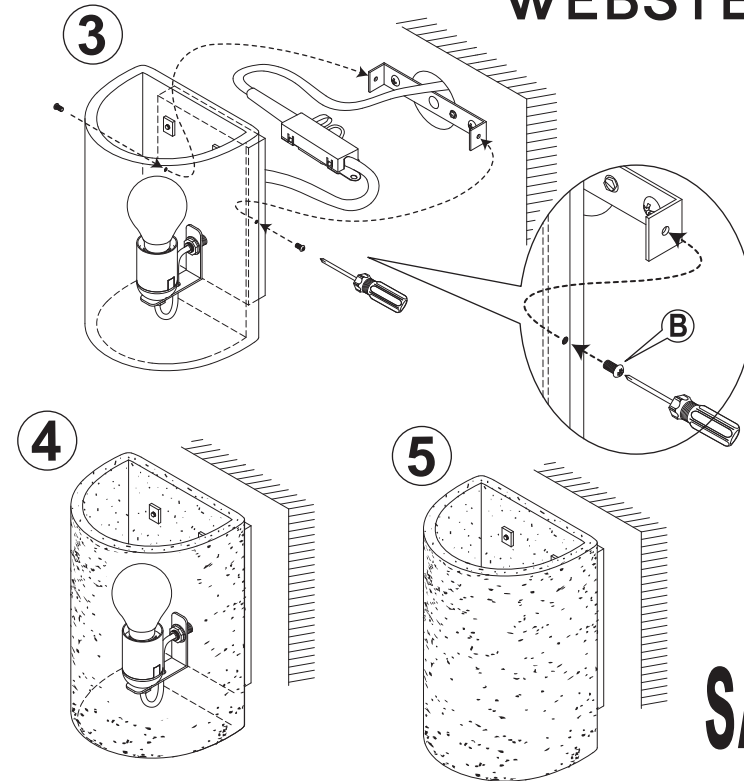
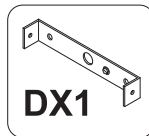
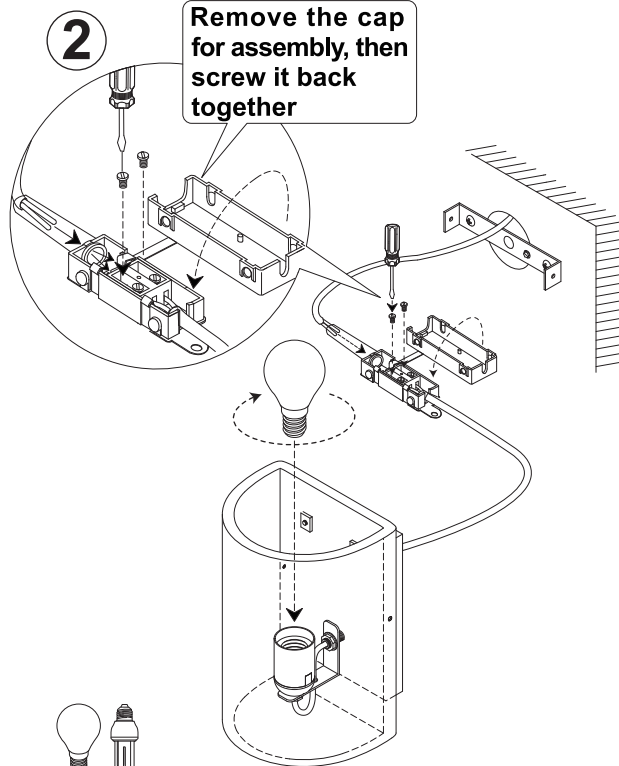
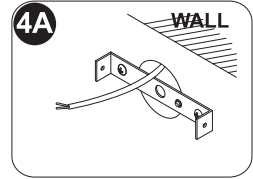
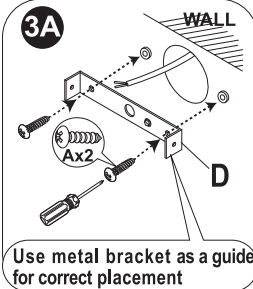
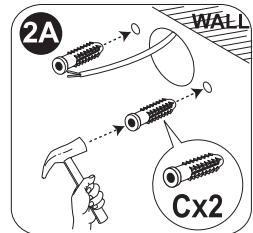
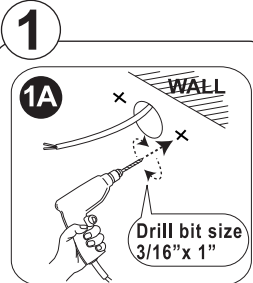

1. Drill bit size 3/16"x1".
2. Remove the cap for assembly, then screw it back together.
3. Push the bottom to adjust the cable wire.
4. Use metal bracket as a guide for correct placement.
5. Safety:

- Check that all parts and components are in good condition, never install a product that appears to be damaged. It is strongly recommended that you use a professional trades person to install this product.
- Ensure that all electrical fittings and cables are not live during installation. Check for electrical cables or hazards before drilling in to ceiling surface. Do not install this product if any cables become damaged.

ITEM No.: PYCTWSB
 PYCTWSR
 PYCTWSW
 SIZE: 15 X 15 X 20 CM H.
 MAX. 40W E14
 MAX. 8W E14

SAA

PS-CM1B-TEMPLE & WEBSTER