

# 5 TIER BOOKCASE

## ASSEMBLY INSTRUCTIONS

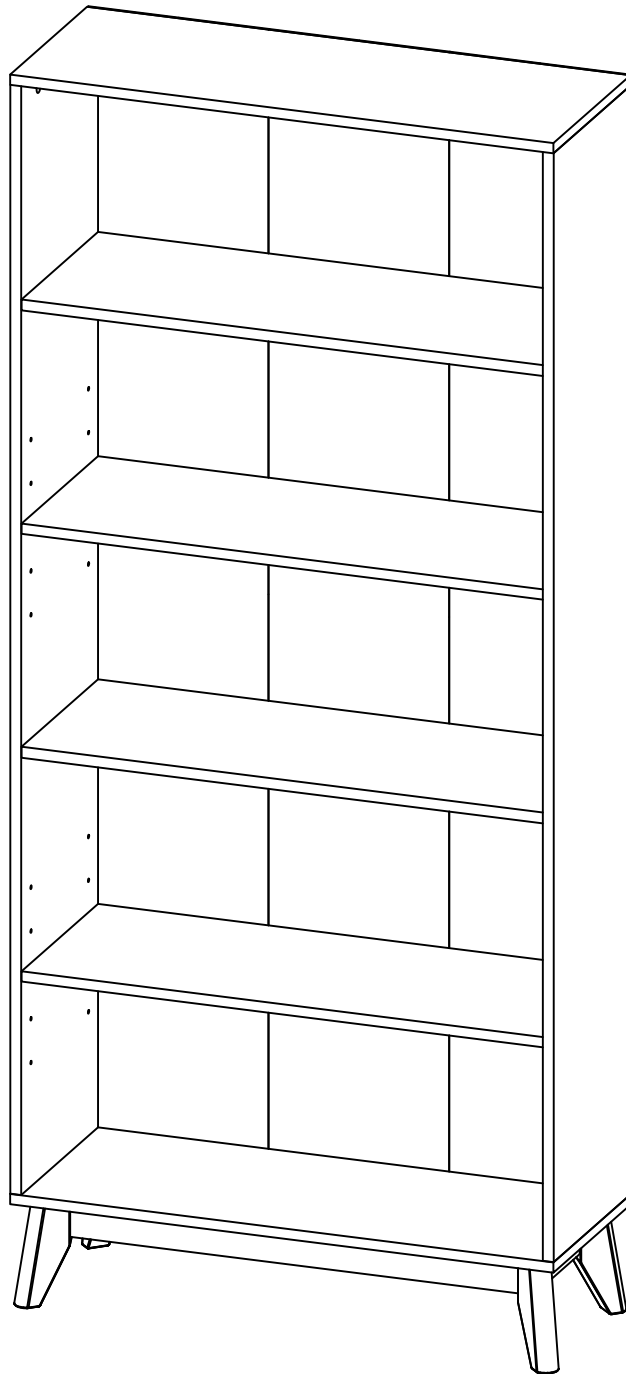

# TIPS BEFORE YOU START

---

1. Please check that all parts are present before you start the assembly of your furniture.
2. For ease and speed of assembly, we recommend that before you commence each step of the assembly, that you identify all the parts required for that step.
3. For larger items, please ensure that you have sufficient space and people to assemble your product safely.
4. We recommend that, where possible, all items are assembled near to the area in which they will be placed in use, to avoid moving the product unnecessarily once assembled.
5. For the protection of your furniture, we recommend that the product is placed on a protected surface during assembly to prevent any damage.
6. During assembly please take care not to over-tighten any fittings, as this may damage the product. Do not use power tools.
7. Always place the product on a flat, steady and stable surface.
8. Do not stand on the product. Do not use the product as a stepladder.
9. This product is intended for indoor, household use only as it is a non-industrial product.
10. Please use caution and care when lifting the product to avoid personal injury and/or product damage.

## CARE AND MAINTENANCE OF YOUR FURNITURE

- ☑ Please periodically check all fittings and re-tighten as necessary.
- ☑ To clean your item, please use a damp cloth and wipe clean.
- ☑ To clean glass, please use glass cleaner.
- ☑ Never allow any kind of liquid to remain on your furniture. Absorption can cause wood to warp or finishes to de-laminate.
- ☑ Please do not place hot items (eg. hot drinks) directly on to the surface.
- ☑ Please do not drag and pull your furniture.

## ASSEMBLY REQUIREMENTS

- ☑ Equipment: phillips head screwdriver, flat head screwdriver, hammer
- ☑ 2 x adults required
- ☑ 2m x 2m assembly space required
- ☑ 1 hour assembly time approx.

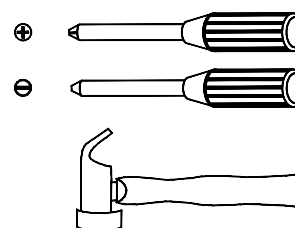
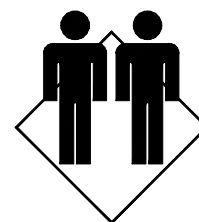

# ANTI-TOPPLING WARNING

## CHILDREN HAVE DIED FORM FURNITURE TIPOVER.

- **ALWAYS** secure this furniture with an anchor device
- **NEVER** allow children to stand, climb or hang on doors or shelves
- **NEVER** open more than one drawer at a time
- **ALWAYS** secure your television to this furniture with an anchor device or mount the television on a wall

For more infirmation, visit <https://www.productsafety.gov.au>

**! WARNING**



**Children have died from furniture tipover.**

- ALWAYS secure this furniture with an anchor device.
- NEVER allow children to stand, climb or hang on drawers, doors, or shelves.
- NEVER open more than one drawer at a time.
- Place heavy items down low.

NEVER put a TV on this furniture 

# USING CAM LOCK AND QUICKFIT

## QUICKFIT

Tighten quickfit until shoulder is flush with panel. Do not overtighten or undertighten.

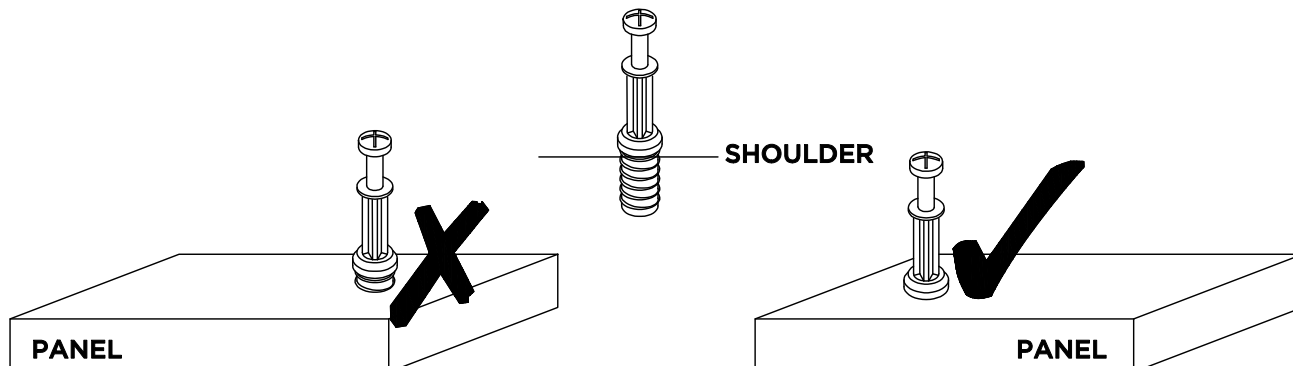

## CAM LOCK

When fitting cam lock, ensure starting position is correct before you insert connecting quickfit.

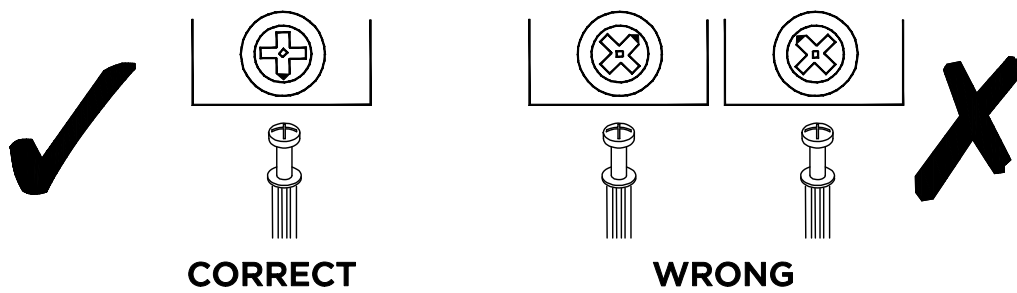

Quickfit head should be in the centre of the cam lock when the two panels are joined.  
Cam lock should be inserted before quickfit.

Turn cam lock clockwise to tighten.

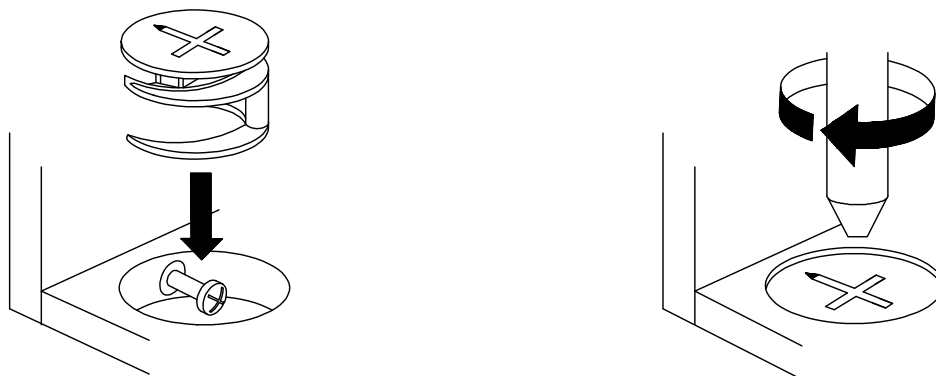

# HARDWARE LIST

---



12 x A  
Cam Lock

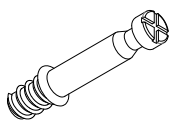

12 x B  
Quickfit Screw

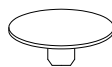

12 x C  
Cam Lock Cover

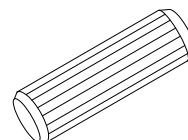

16 x D  
Wooden Dowel

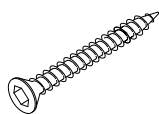

4 x E  
Screw

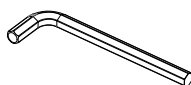

1 x F  
Allen Key

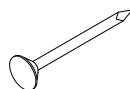

34 x G  
Nail

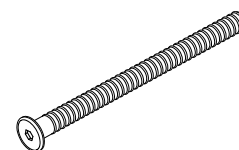

8 x H  
Bolt

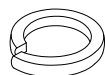

8 x I  
Spring Washer

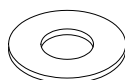

8 x J  
Washer



8 x K  
Shelf Support



4 x L  
Wall Bracket

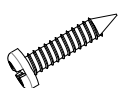

2 x M  
Screw

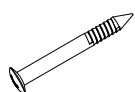

2 x N  
Screw

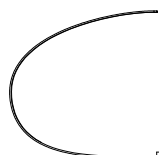

2 x O  
Cable Tie

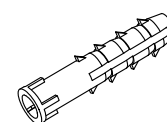

2 x P  
Wall Plug  
(Not Provided)

# PARTS LIST

---

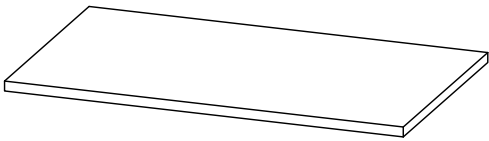

**1**  
1 PC

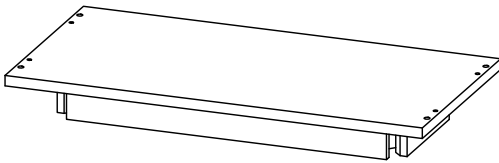

**2**  
1 PC

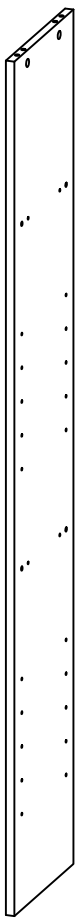

**3**  
1 PC



**4**  
1 PC

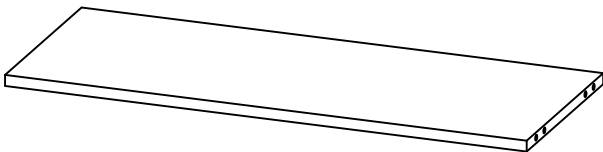

**5**  
2 PCS

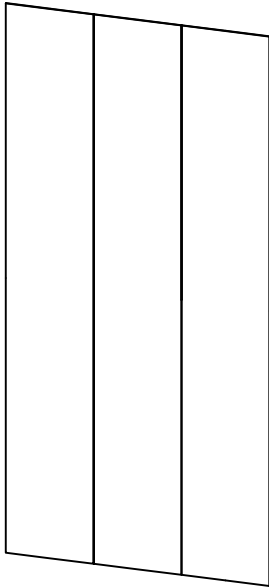

**6**  
1 PC

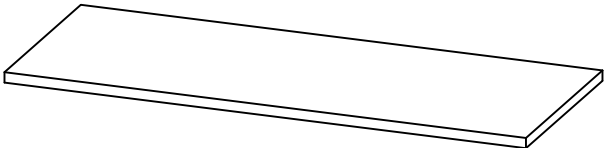

**7**  
2 PCS

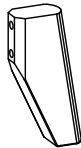

**8**  
4 PCS

# ASSEMBLY INSTRUCTIONS

## STEP 1

Insert cam locks (A) to parts 3,4 and 5, as shown.

Insert quick fit screws (B) to parts 1, 3 and 4, as shown.

Insert wooden dowels (D) to part 3, 4 and 5, ad shown.

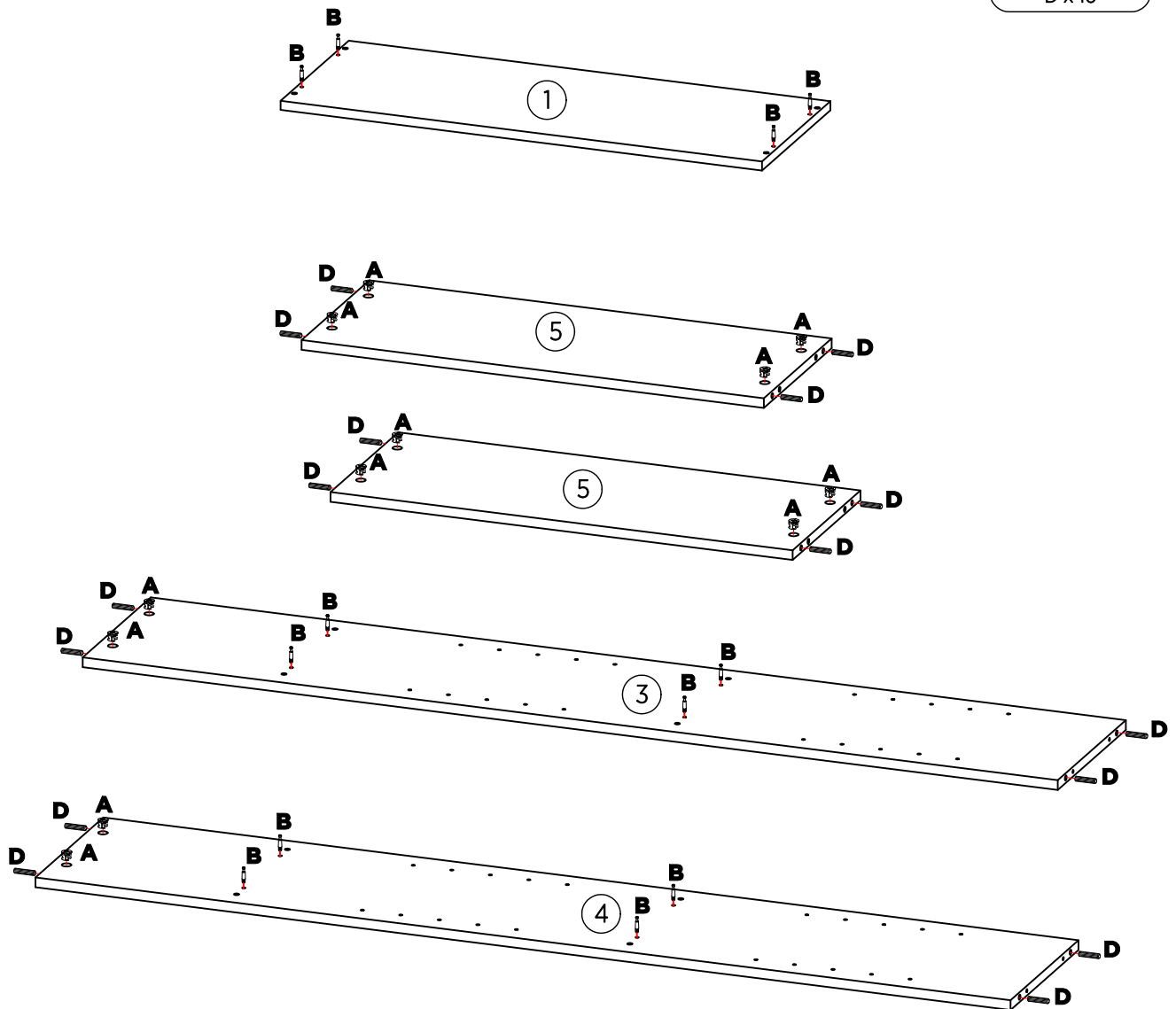
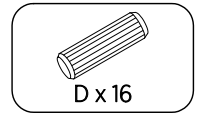
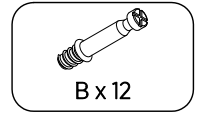
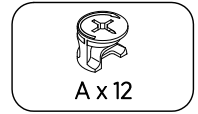

# ASSEMBLY INSTRUCTIONS

## STEP 2

Fix parts 3, 4 and 5, as shown.

Turn cam locks clockwise to tighten.

Place covers (C) over cam locks (A).

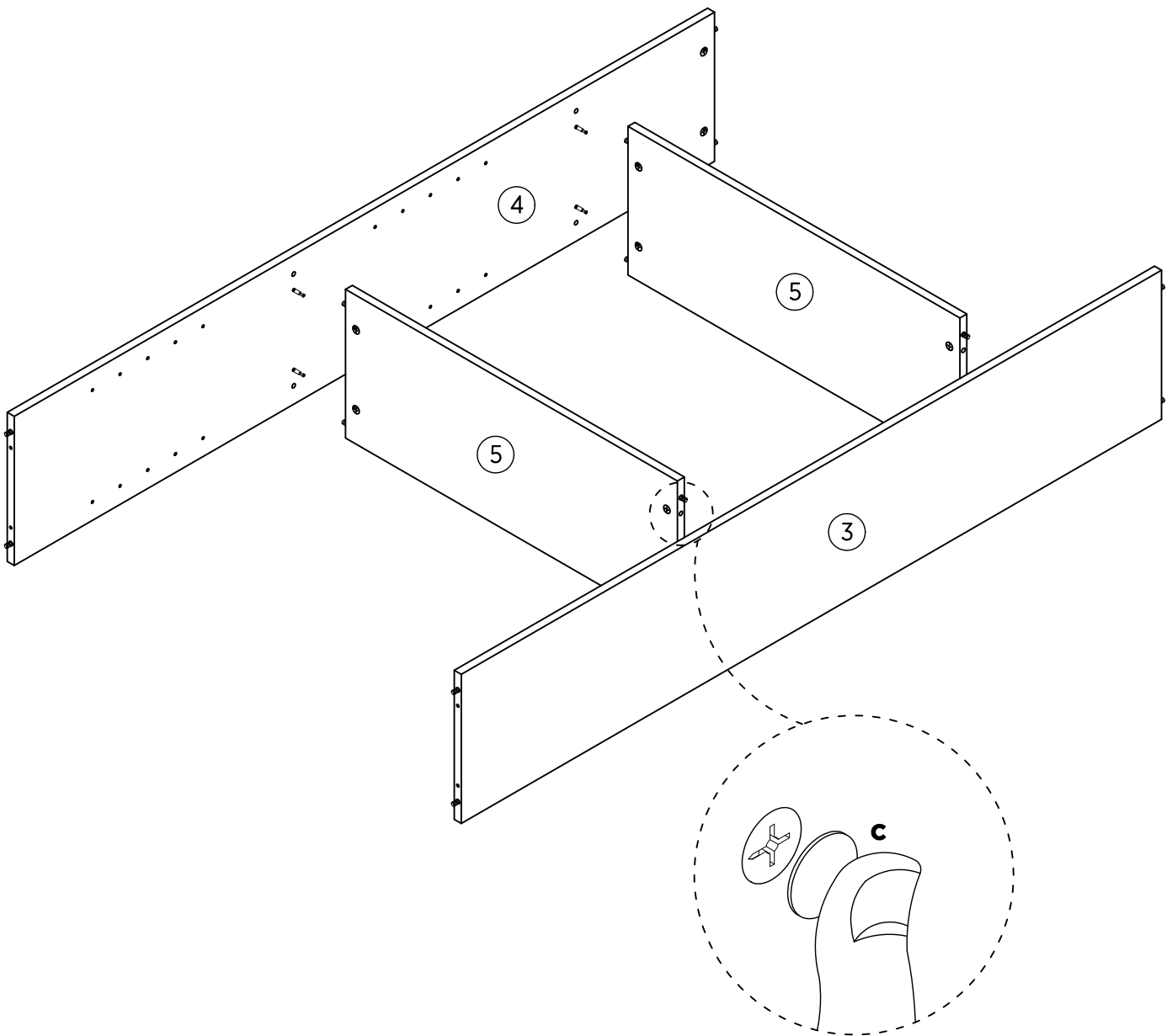
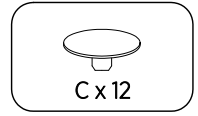

# ASSEMBLY INSTRUCTIONS

## STEP 3

Fix parts 1 to parts 3 and 4, as shown.

Turn cam locks clockwise to tighten.

Place covers (C) over cam locks (A).

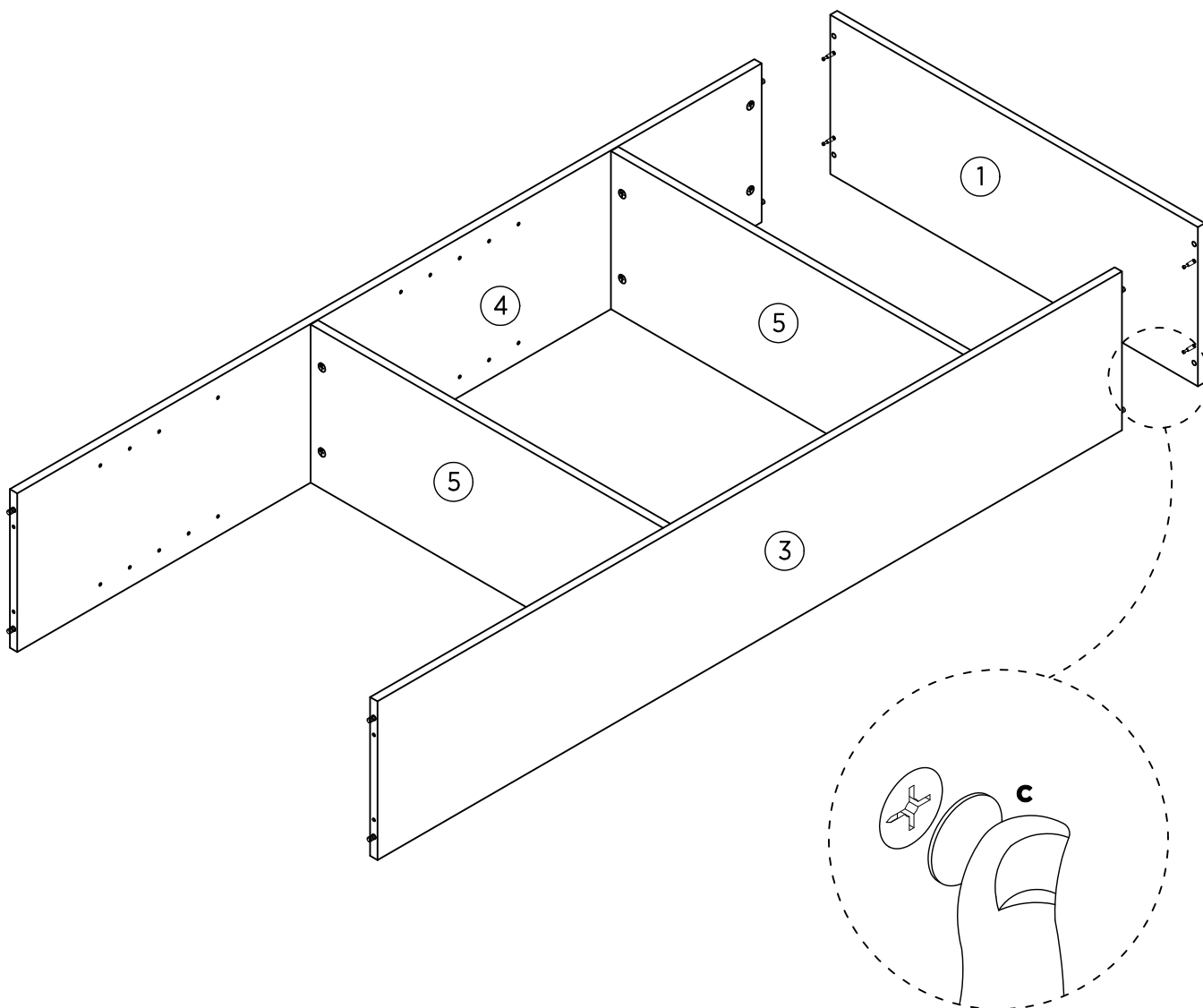
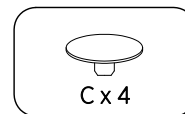

# ASSEMBLY INSTRUCTIONS

## STEP 4

Fix parts 2 to parts 3 and 4 using screws (E) and allen key (F), as shown.

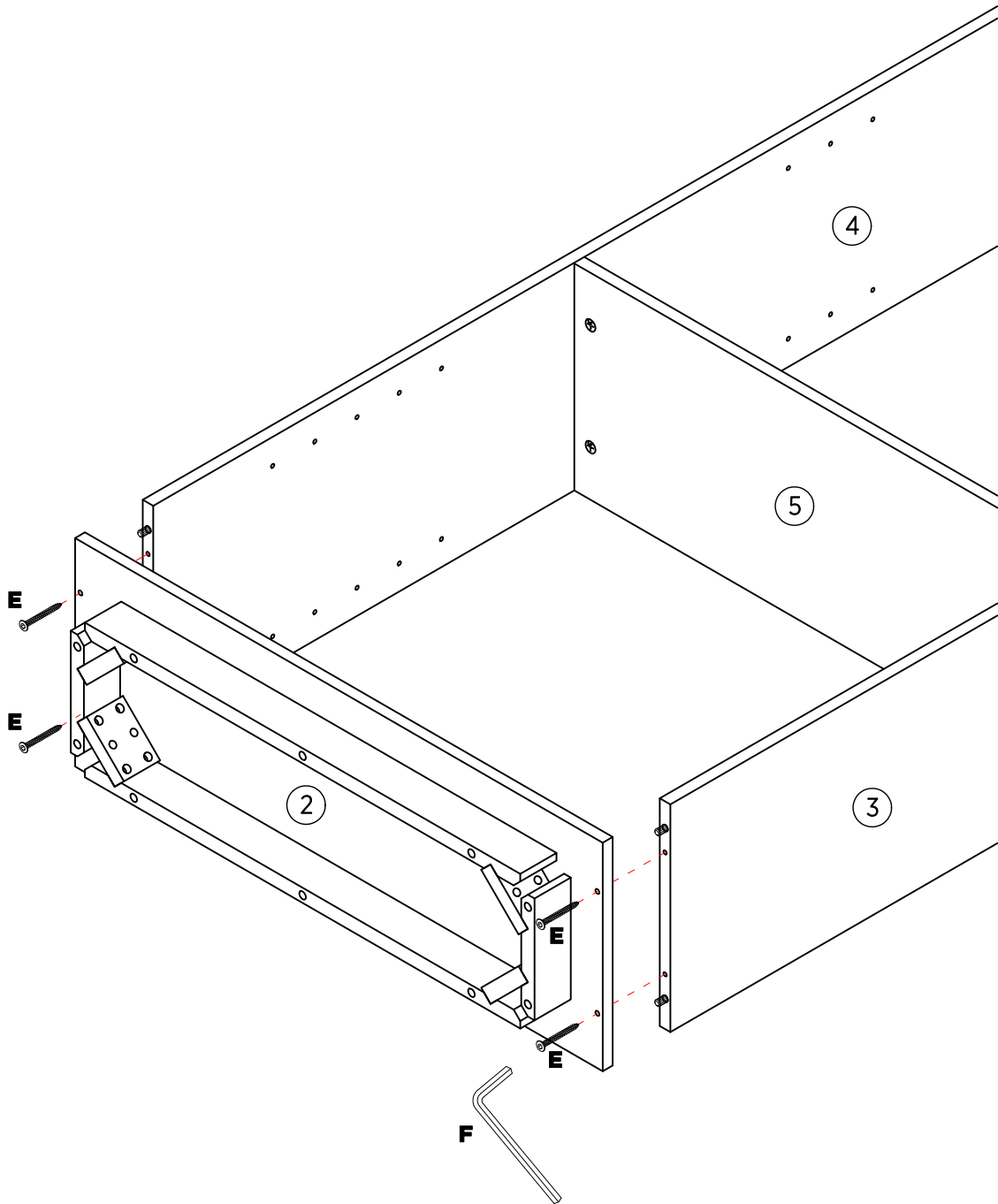
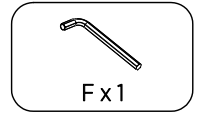
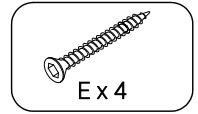

# ASSEMBLY INSTRUCTIONS

## STEP 5

Fix parts 8 to part 2 using bolt (H), spring washer (I), flat washer (J) and allen key (F), as shown.

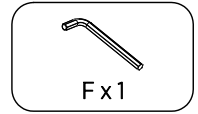

F x 1

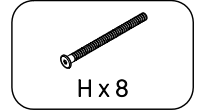

H x 8

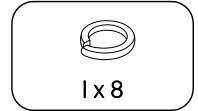

I x 8

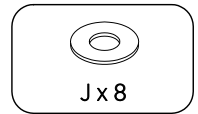

J x 8

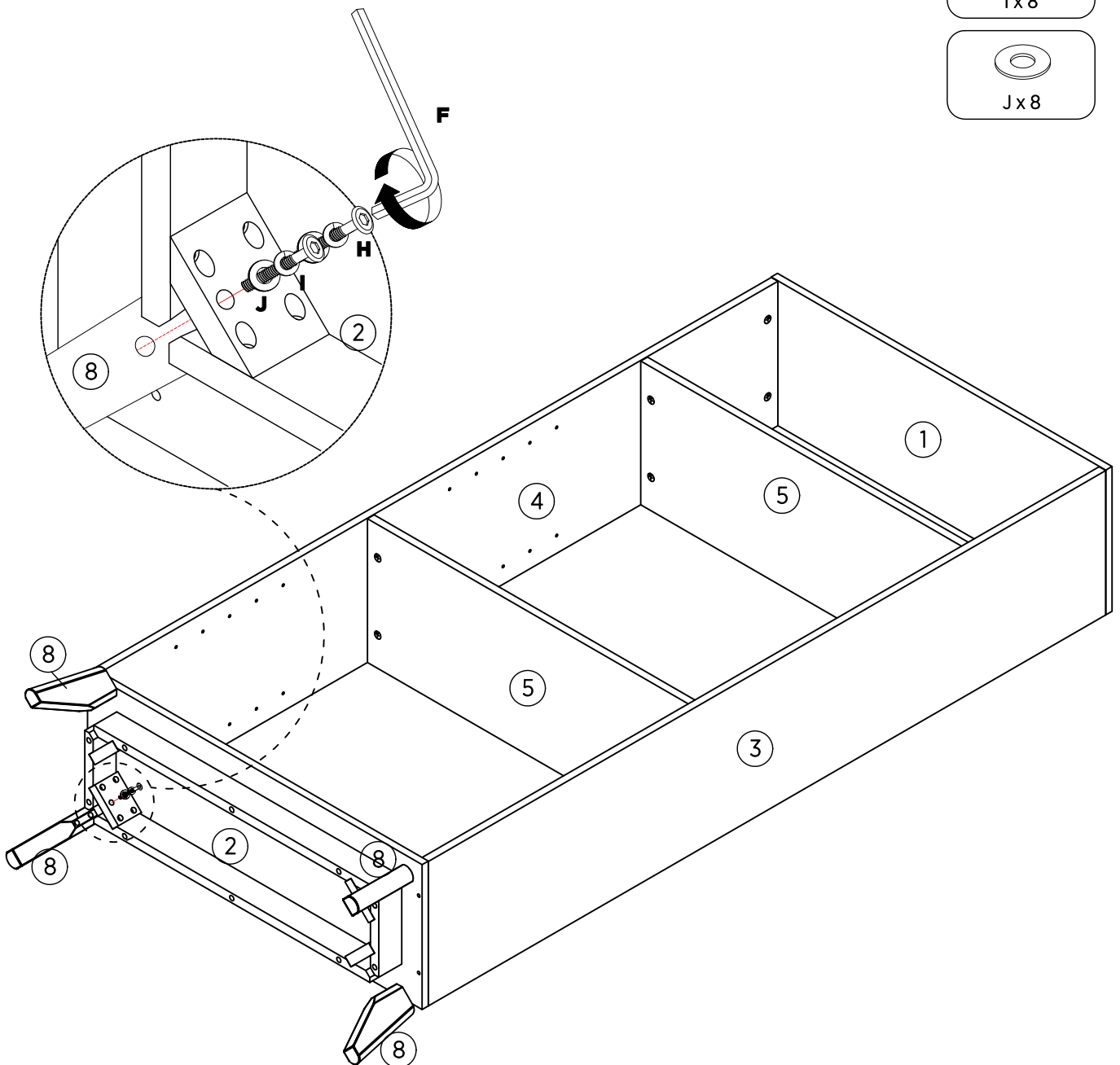

# ASSEMBLY INSTRUCTIONS

## STEP 6

Fix part 6 to assembled unit using nails (G), as shown.

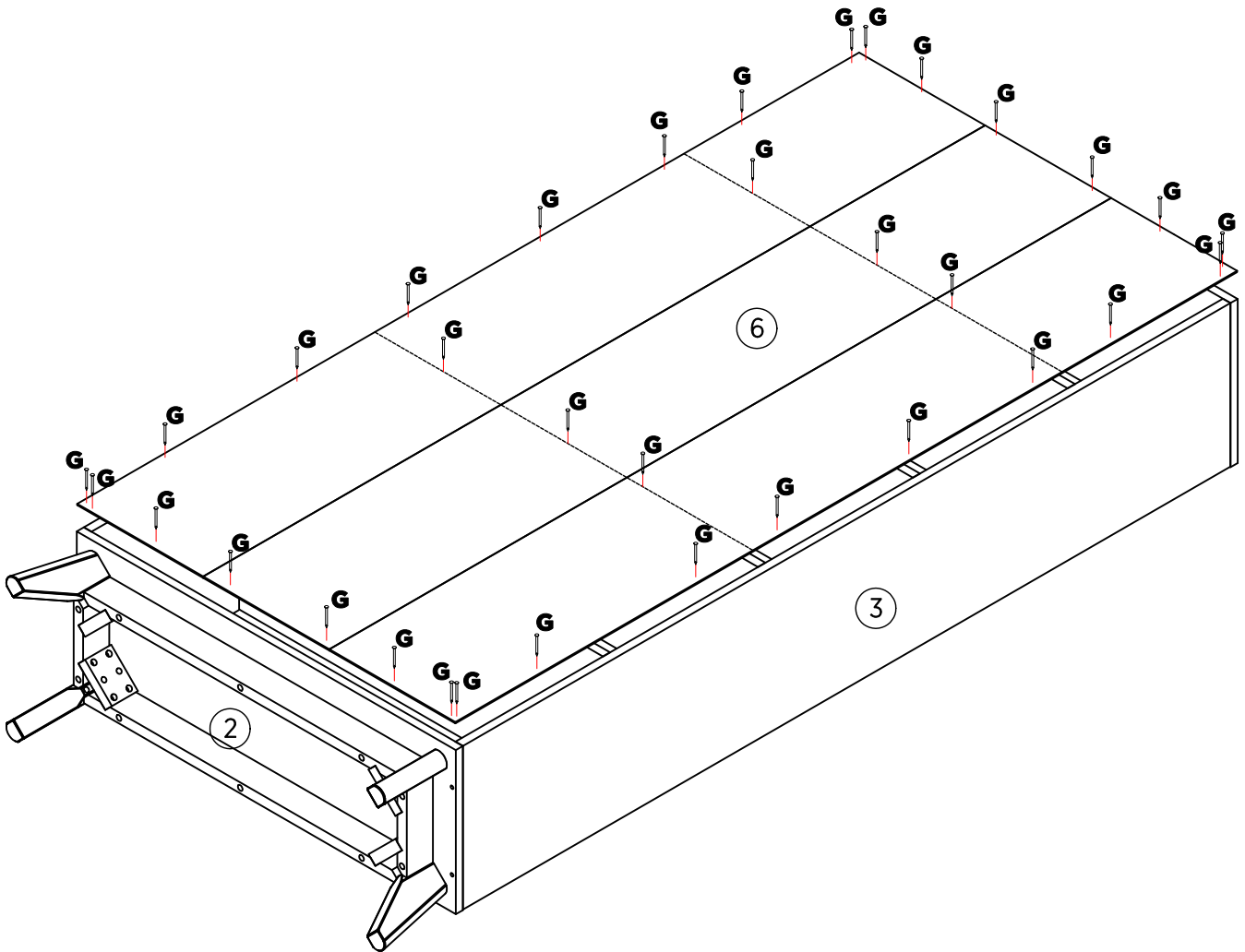
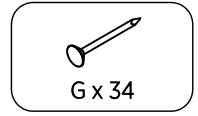

# ASSEMBLY INSTRUCTIONS

## STEP 7

Insert metal shelf support (K) to parts 3 and 4.

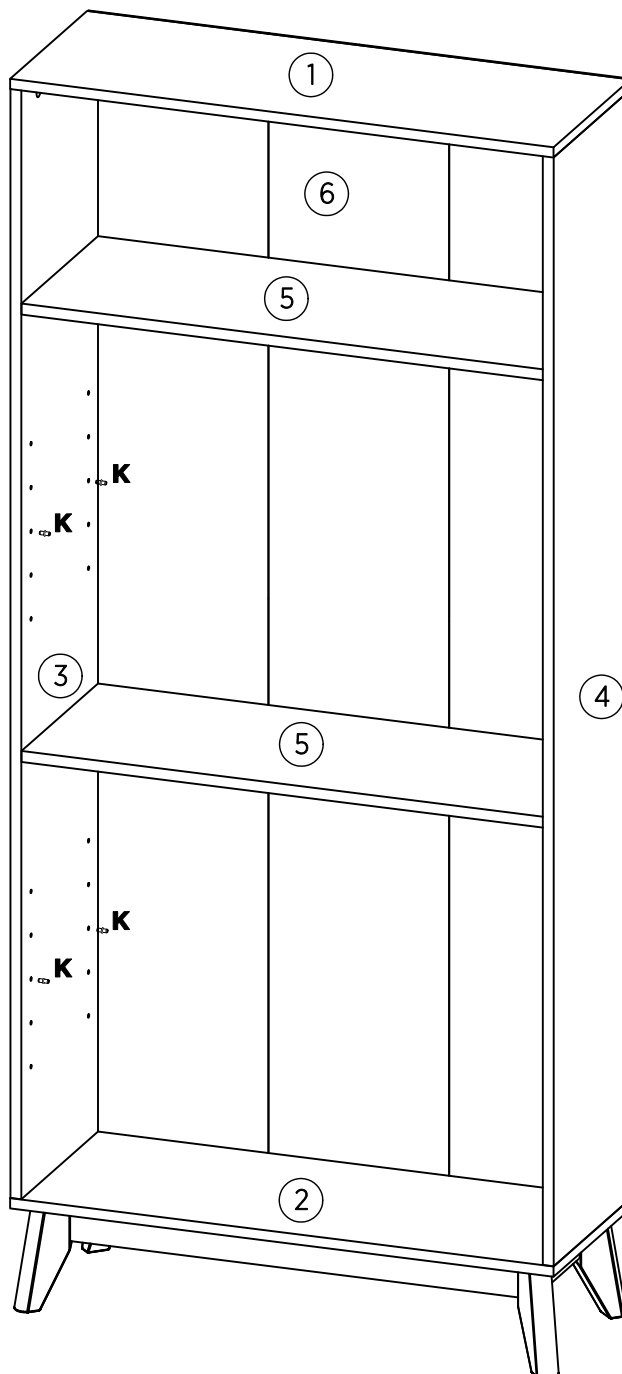
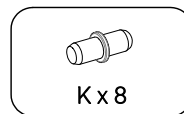

# ASSEMBLY INSTRUCTIONS

---

## STEP 8

Place shelves 7 to assembled unit, as shown.

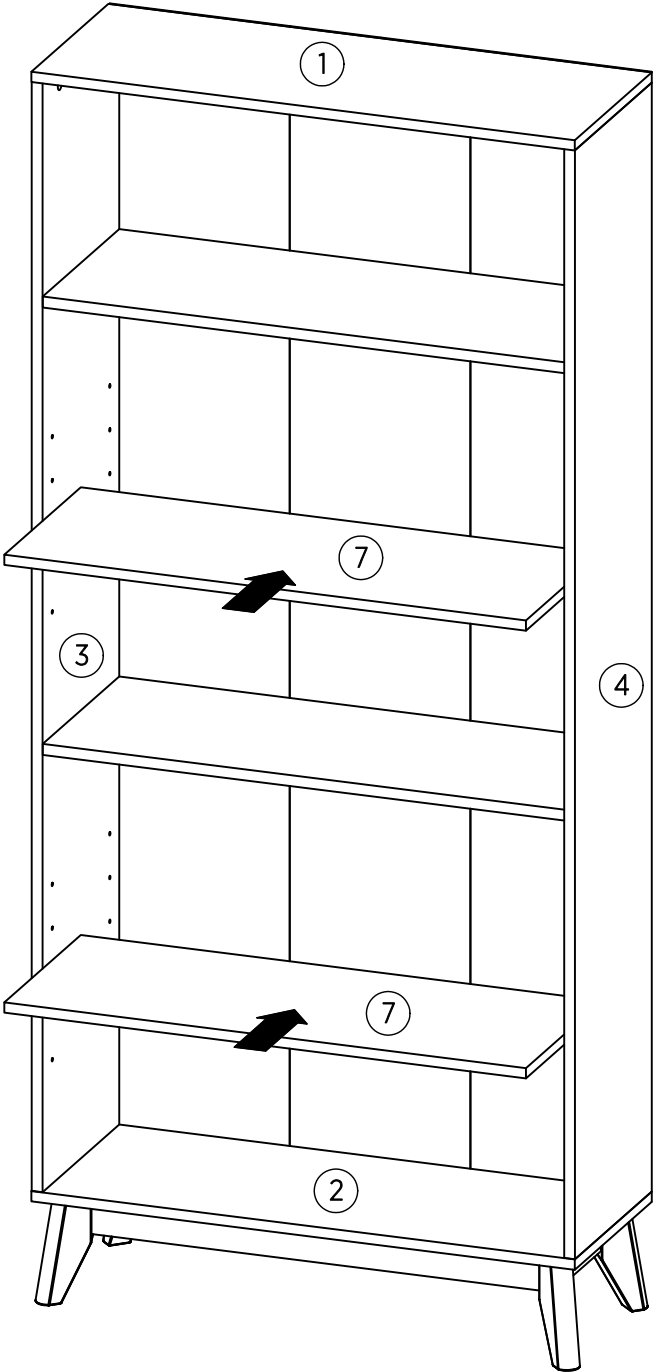

# ASSEMBLY INSTRUCTIONS

## STEP 9

Fix wall bracket (L) to part 6 using screws (M), as shown.

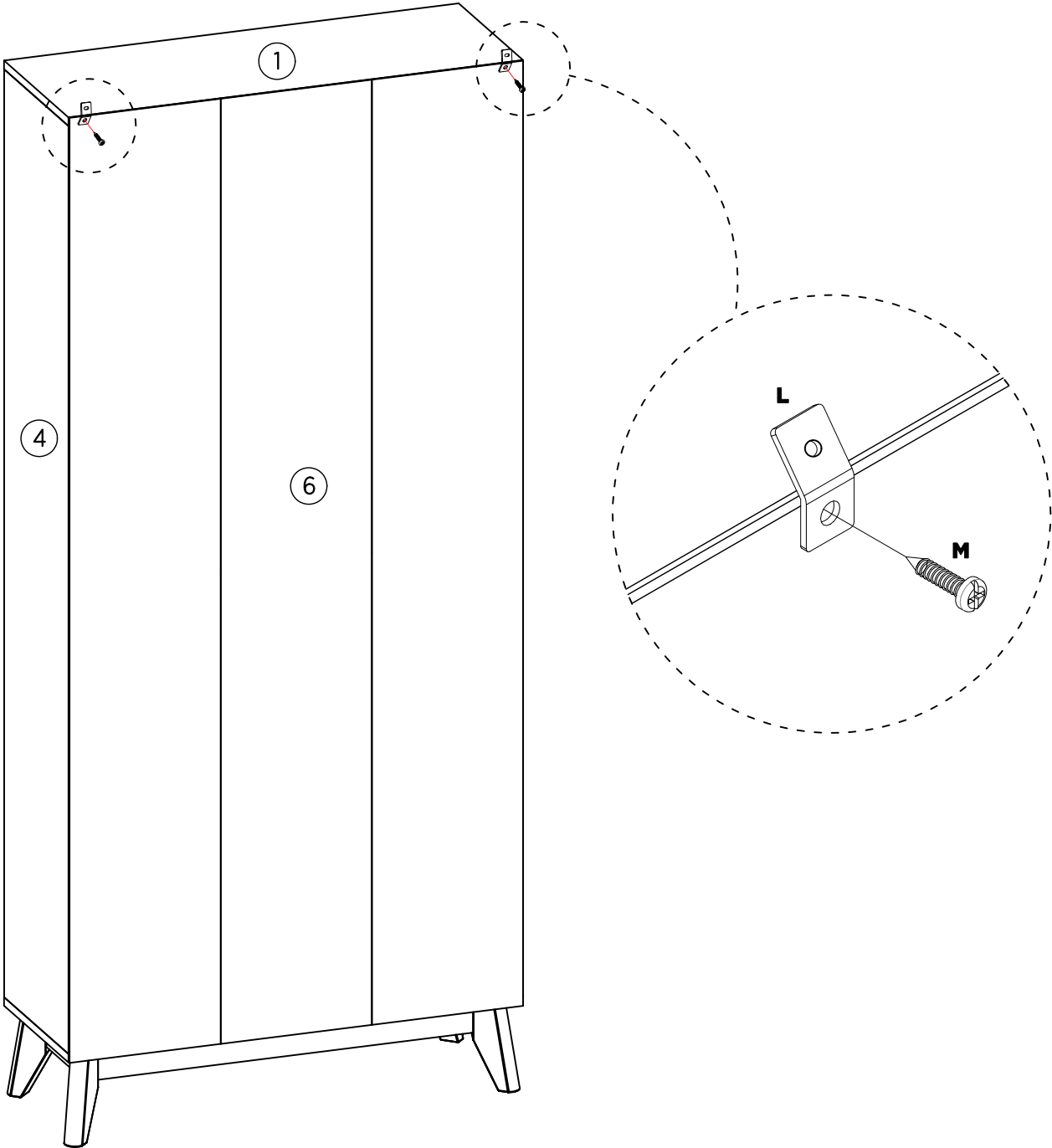
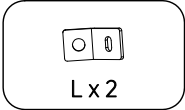

# ASSEMBLY INSTRUCTIONS

## STEP 10

**For extra stability, you must fix your product to the wall.  
Should you choose not to affix the product to the wall, serious injury may be caused if the product tips over.**

Screw (N) is fixed through wall bracket (L) and into the wall plug (P).

Tighten wall brackets (L) with cable ties (O), as shown.

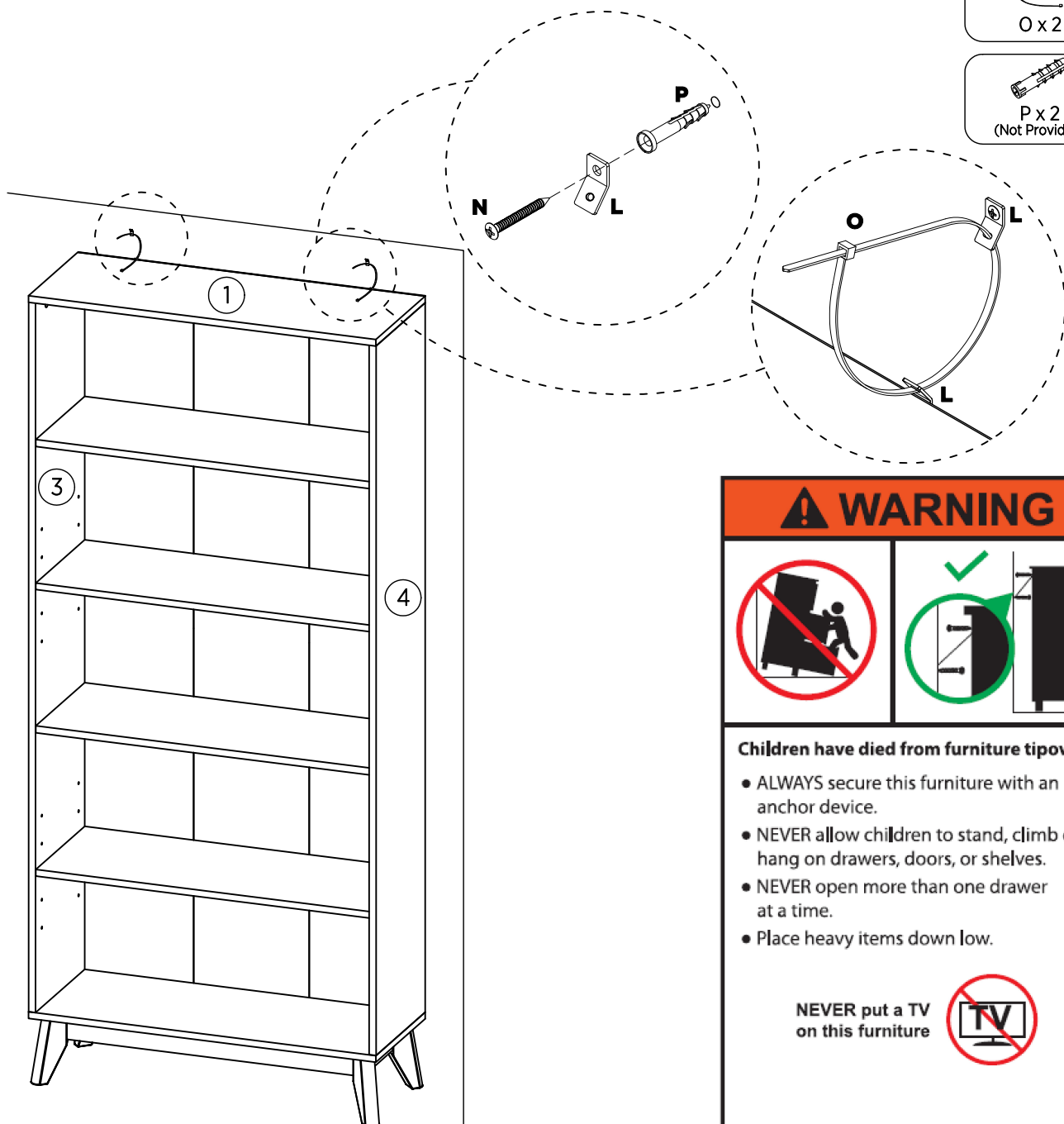
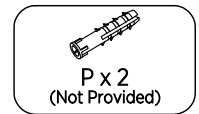
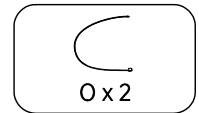
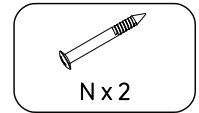
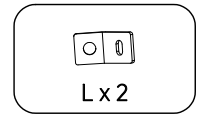

**! WARNING**

**Children have died from furniture tipover.**

- ALWAYS secure this furniture with an anchor device.
- NEVER allow children to stand, climb or hang on drawers, doors, or shelves.
- NEVER open more than one drawer at a time.
- Place heavy items down low.

NEVER put a TV on this furniture

# ASSEMBLY INSTRUCTIONS

---

## STEP 11

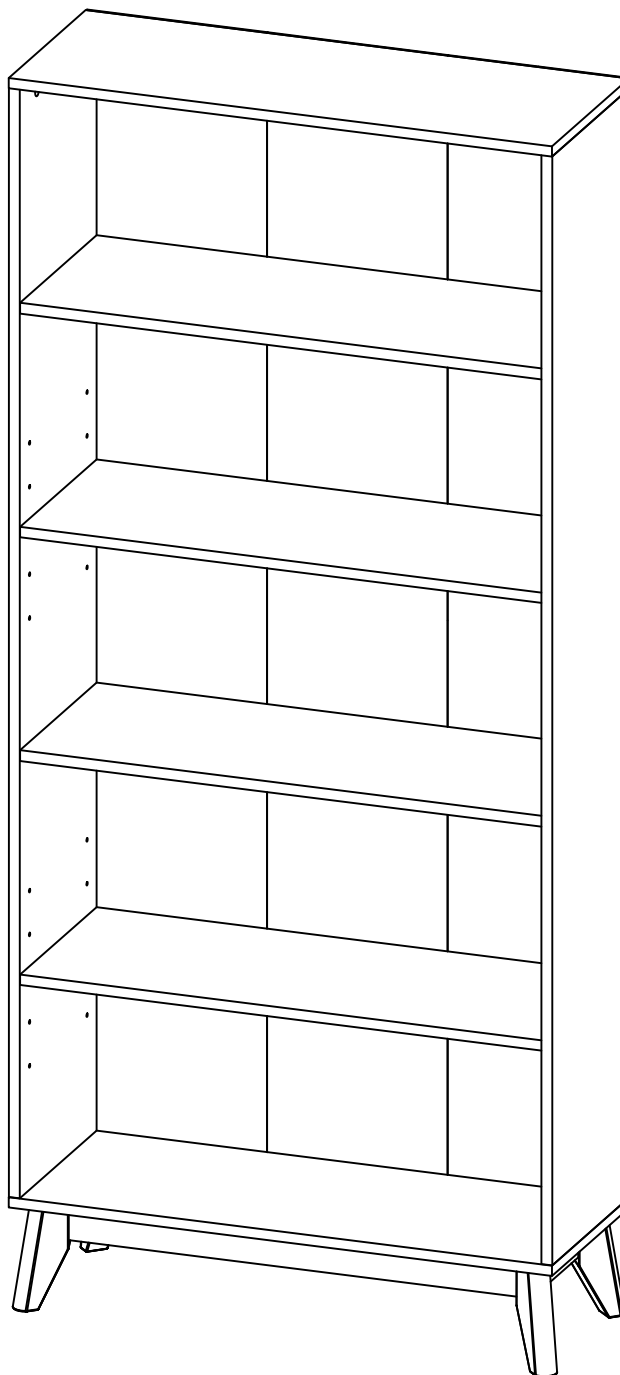

**Please note: the maximum recommended weight is 10kg per shelf.**

Your 5 Tier Bookcake is ready for use.

# WALL FIXING GUIDE

**NOTE: Supplied wall plugs are only suitable for use in masonry walls.**

If you have any doubts about using the correct plug for your wall, please seek professional advice. Failure of the product due to using incorrect fixings is the responsibility of the installer.



## IMPORTANT:

**When drilling into walls, always check for hidden wires or pipes, etc.**



## Tips & Tricks

**Make sure that the hardware used is suitable for supporting your unit.**

**Please consult a qualified tradesperson if unsure.**

- ✓ If you are unsure, please select a larger screw and wall plug.
- ✓ Ensure that you use the recommended drill bit to match the wall plug and hole size.
- ✓ Take extra care when drilling high walls, ceiling and ceramic tiles. Ensure wall plugs are inserted beyond the thickness of the ceramic tiles to avoid splitting or cracking.
- ✓ Ensure that wall plugs are well fitted and are a tight fit in the drilled hole.

## Types of Walls

Use one of the following types of wall plug (not included) if your walls are made of brick, breeze block, concrete, stone or wood. Screws may be able to be fixed directly to solid wood walls as they will provide a secure anchor point.

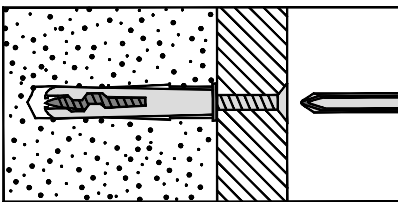

**1. General Purpose Wall Plug**

Generally, aerated blocks should not be used to support heavy loads, use a specialist fitting in this case. For light loads, general purpose wall plugs can be used.

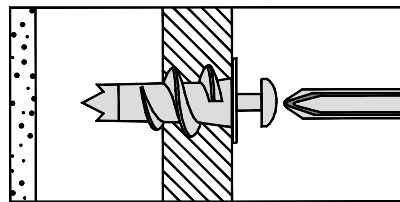

**2. Plasterboard Wall Plug**

For use when attaching light loads onto plasterboard partitions.

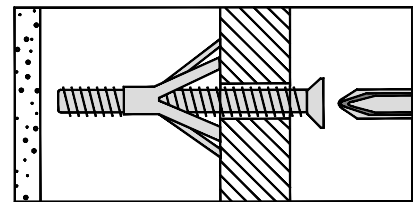

**3. Cavity Fixing Wall Plug**

For use with plasterboard partitions or hollow wooden doors.

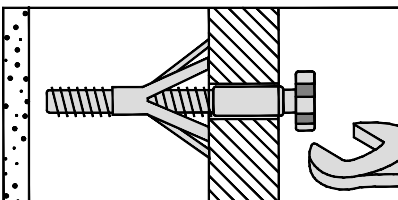

**4. Cavity Fixing Heavy Duty Wall Plug**

For use when fitting or supporting heavy loads such as shelving and wall cabinets.

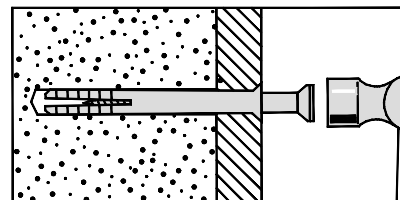

**5. Hammer Fixing Wall Plug**

For use with concrete block or brick walls, or walls stuck with plasterboard. The hammer fixing allows it to be fixed to the wall rather than the plasterboard. Always check the fixing is secure to the retaining wall.

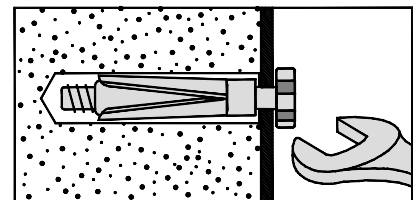

**6. Shield Anchor Wall Plug Heavy Loads**

For use with concrete or brick walls, or for use with heavier loads such as TV & HiFi speakers and satellite dishes, etc.