

BOOKCASE 5 TIER

ASSEMBLY INSTRUCTIONS

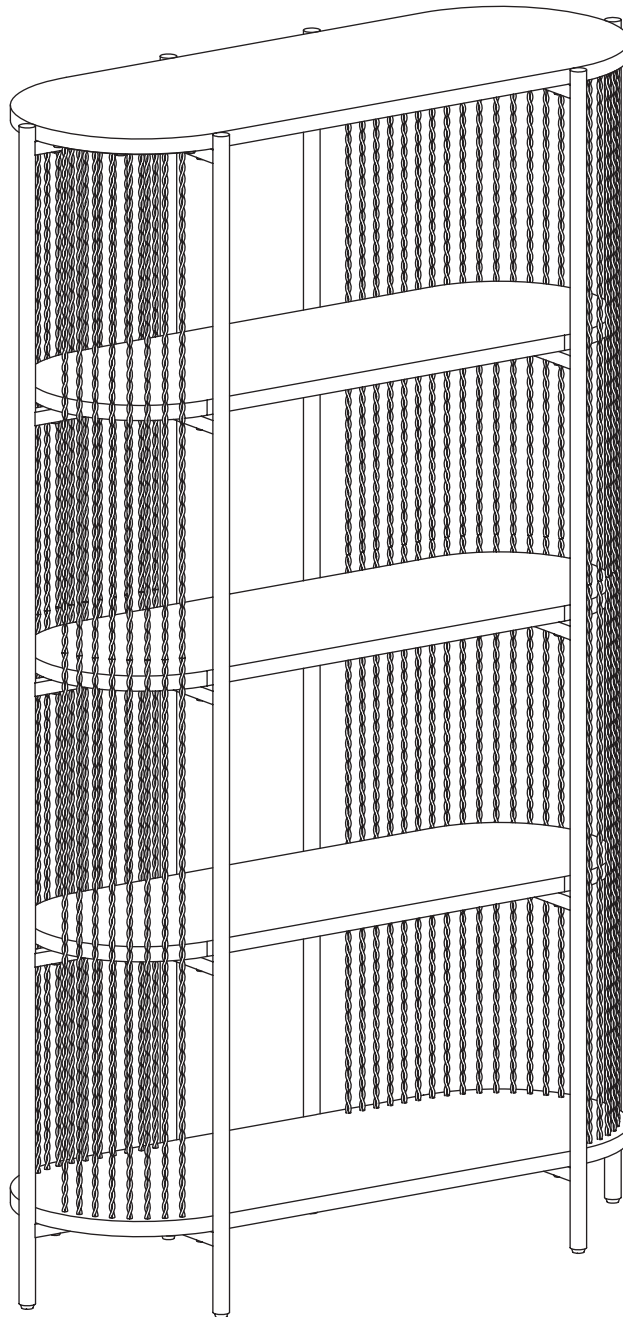

TIPS BEFORE YOU START

1. Please check that all parts are present before you start the assembly of your furniture.
2. For ease and speed of assembly, we recommend that before you commence each step of the assembly, that you identify all the parts required for that step.
3. For larger items, please ensure that you have sufficient space and people to assemble your product safely.
4. We recommend that, where possible, all items are assembled near to the area in which they will be placed in use, to avoid moving the product unnecessarily once assembled.
5. For the protection of your furniture, we recommend that the product is placed on a protected surface during assembly to prevent any damage.
6. During assembly please take care not to over-tighten any fittings, as this may damage the product. Do not use power tools.
7. Always place the product on a flat, steady and stable surface.
8. Do not stand on the product. Do not use the product as a stepladder.
9. This product is intended for indoor, household use only as it is a non-industrial product.
10. Please use caution and care when lifting the product to avoid personal injury and/or product damage.

CARE AND MAINTENANCE OF YOUR FURNITURE

- Please periodically check all fittings and re-tighten as necessary.
- To clean your item, please use a damp cloth and wipe clean.
- To clean glass, please use glass cleaner.
- Never allow any kind of liquid to remain on your furniture. Absorption can cause wood to warp or finishes to de-laminate.
- Please do not place hot items (eg. hot drinks) directly on to the surface.
- Please do not drag and pull your furniture.

ASSEMBLY REQUIREMENTS

- 2 x adults required
- 1.5m x 2m assembly space required
- 1 hour assembly time approx.

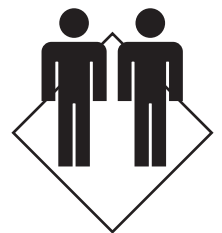

HARDWARE LIST

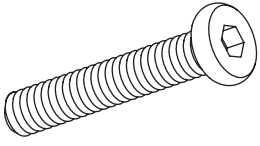

60 x A
Bolt

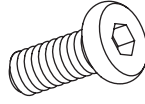

12 x B
Bolt

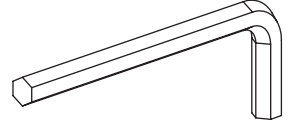

1 x C
Allen Key

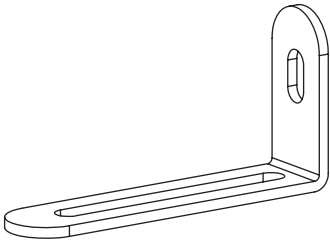

1 x D
Wall Bracket



1 x E
Screw



1 x F
Screw

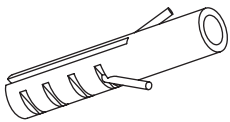

1 x G
Wall Plug

PARTS LIST

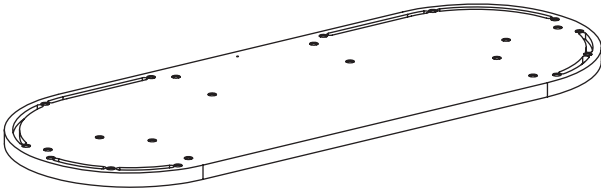

1
1 PC

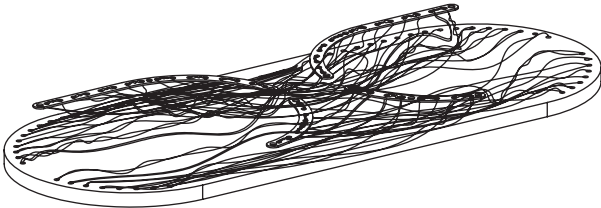

2
1 PC

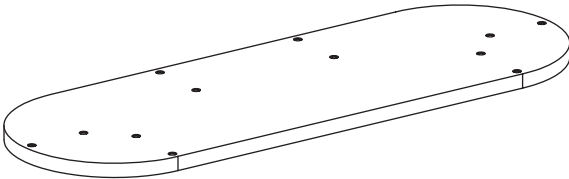

3
3 PCS

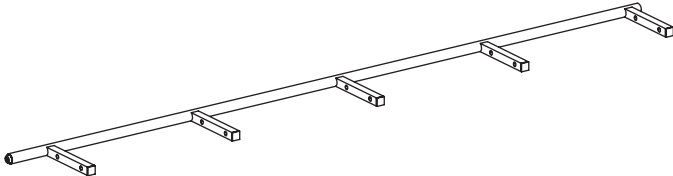

4
6 PCS

ASSEMBLY INSTRUCTIONS

STEP 1

Fix parts 4 to part 1 using bolts (A) and allen key (C), as shown..

Please note: do not fully tighten screws (A) until you complete step 4.

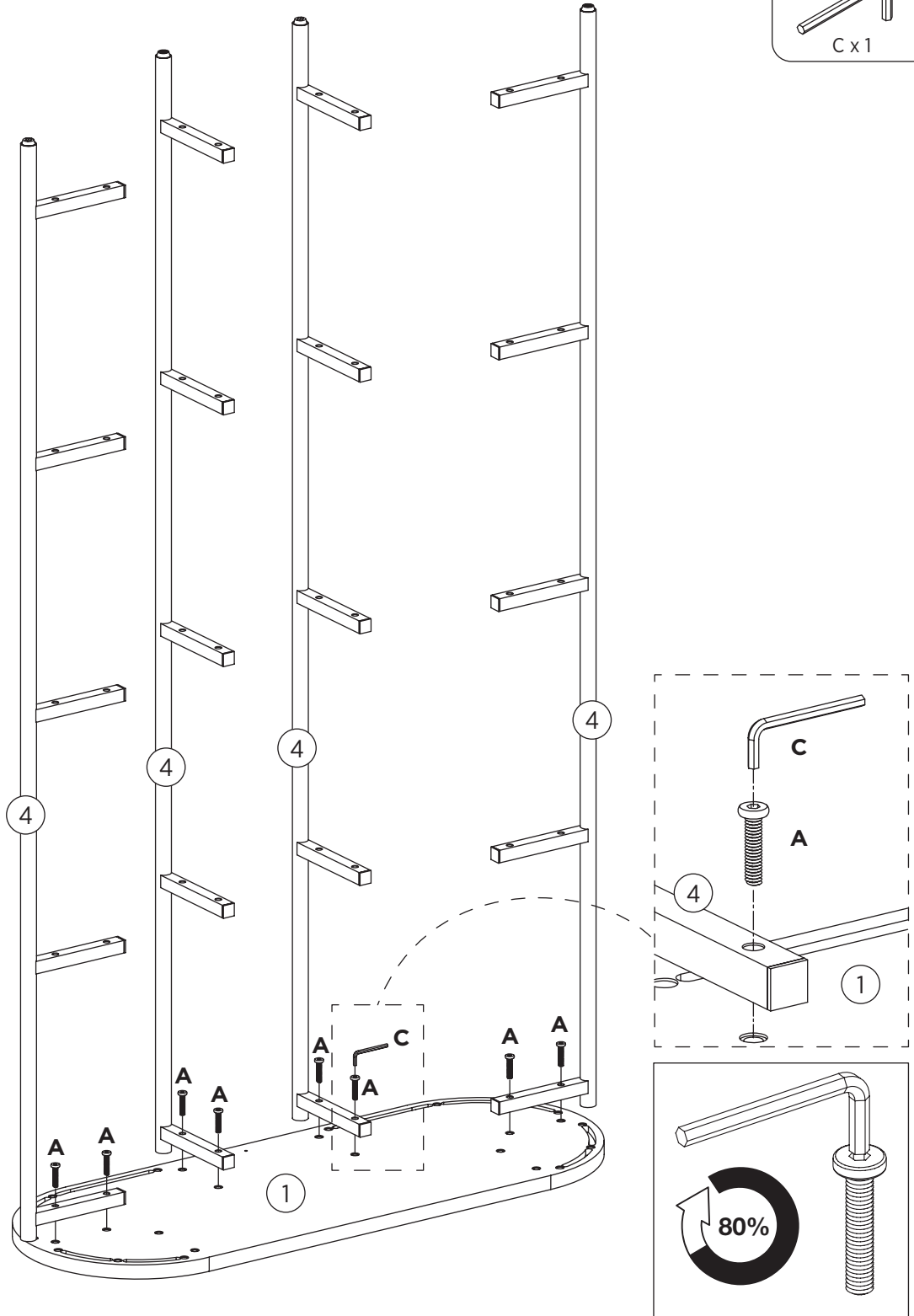
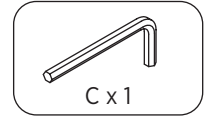
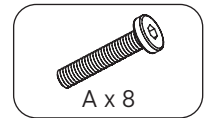

ASSEMBLY INSTRUCTIONS

STEP 2

Fix parts 3 to parts 4 using bolts (A) and allen key (C), as shown..

Please note: do not fully tighten screws (A) until you complete step 4.

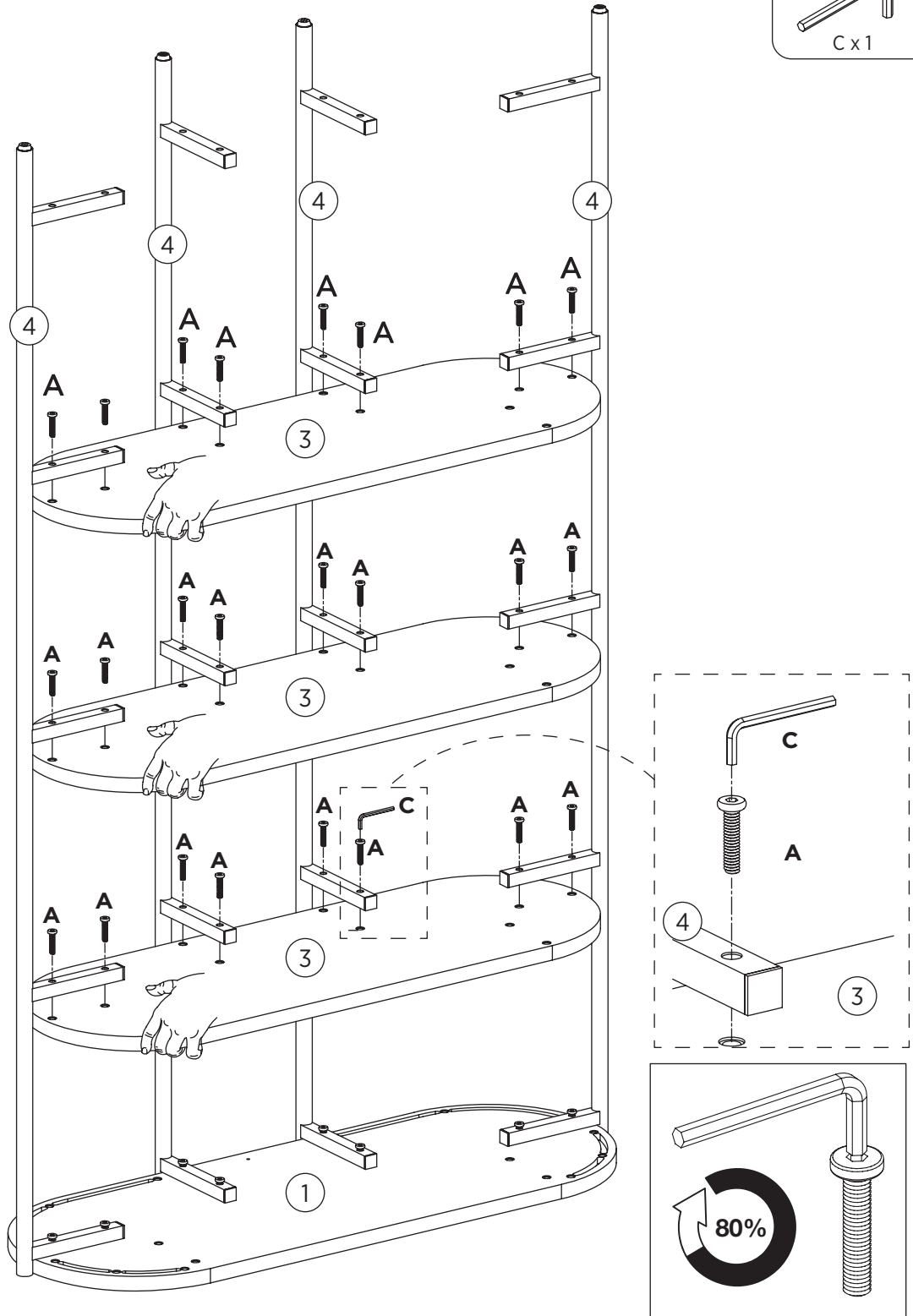
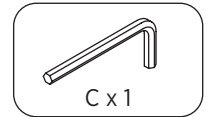
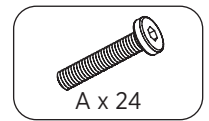

ASSEMBLY INSTRUCTIONS

STEP 3

Fix part 2 to parts 4 using bolts (A) and allen key (C), as shown.

Please note: do not fully tighten screws (A) until you complete step 4.

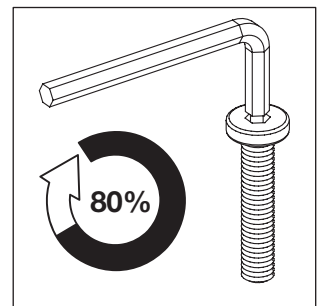
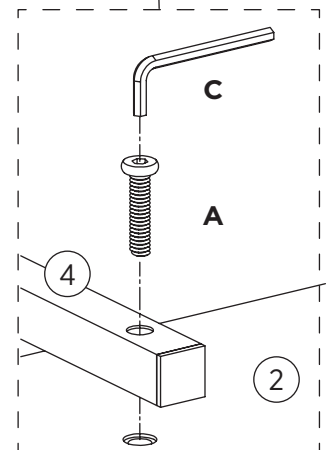
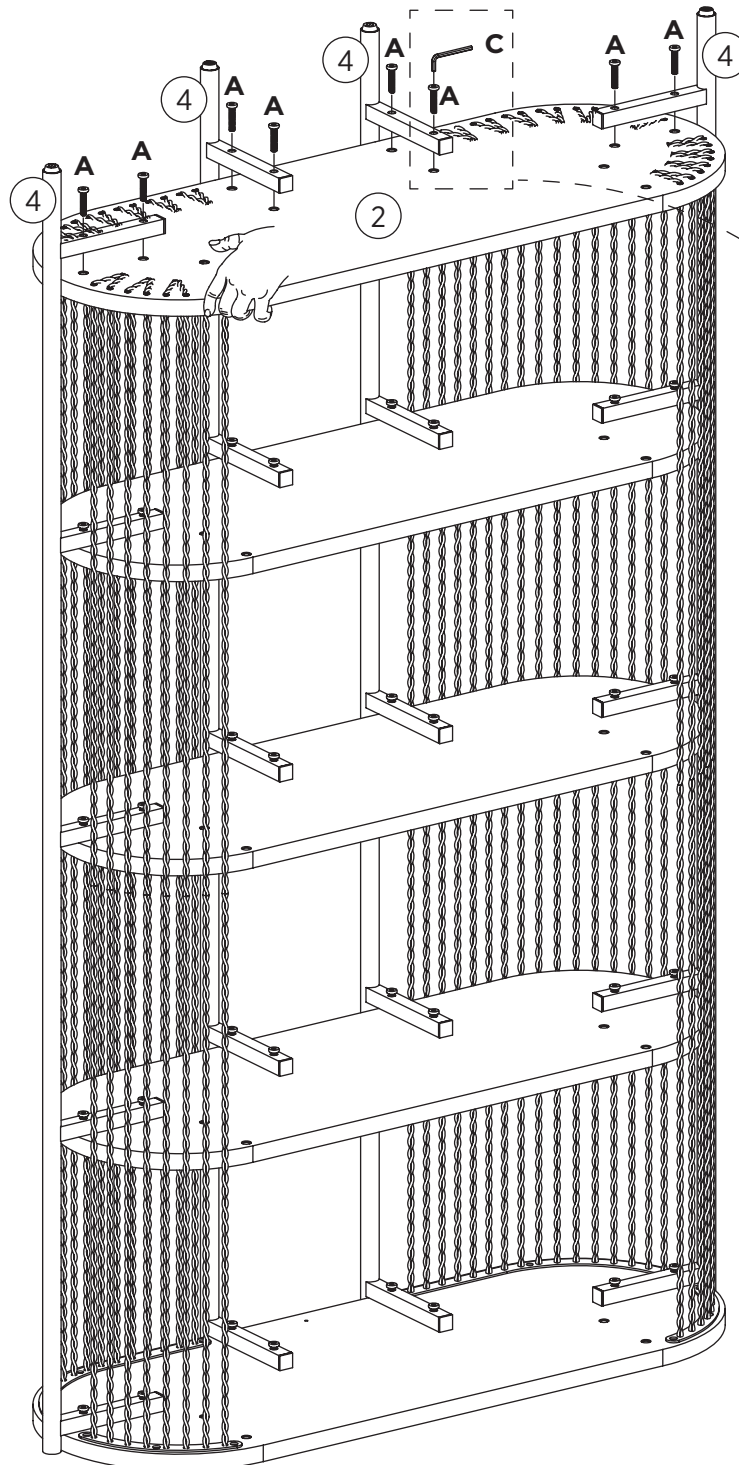
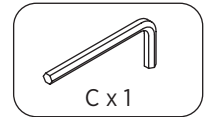
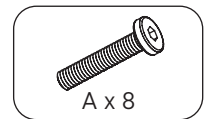

ASSEMBLY INSTRUCTIONS

STEP 4

Fix parts 1, 2 and 3 to parts 4 using bolts (A) and allen key (C), as shown.

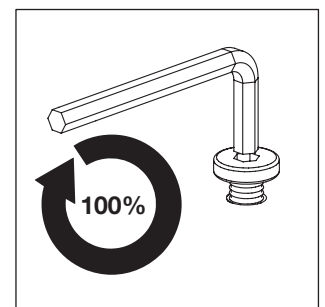
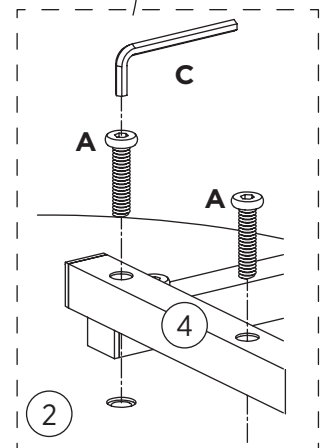
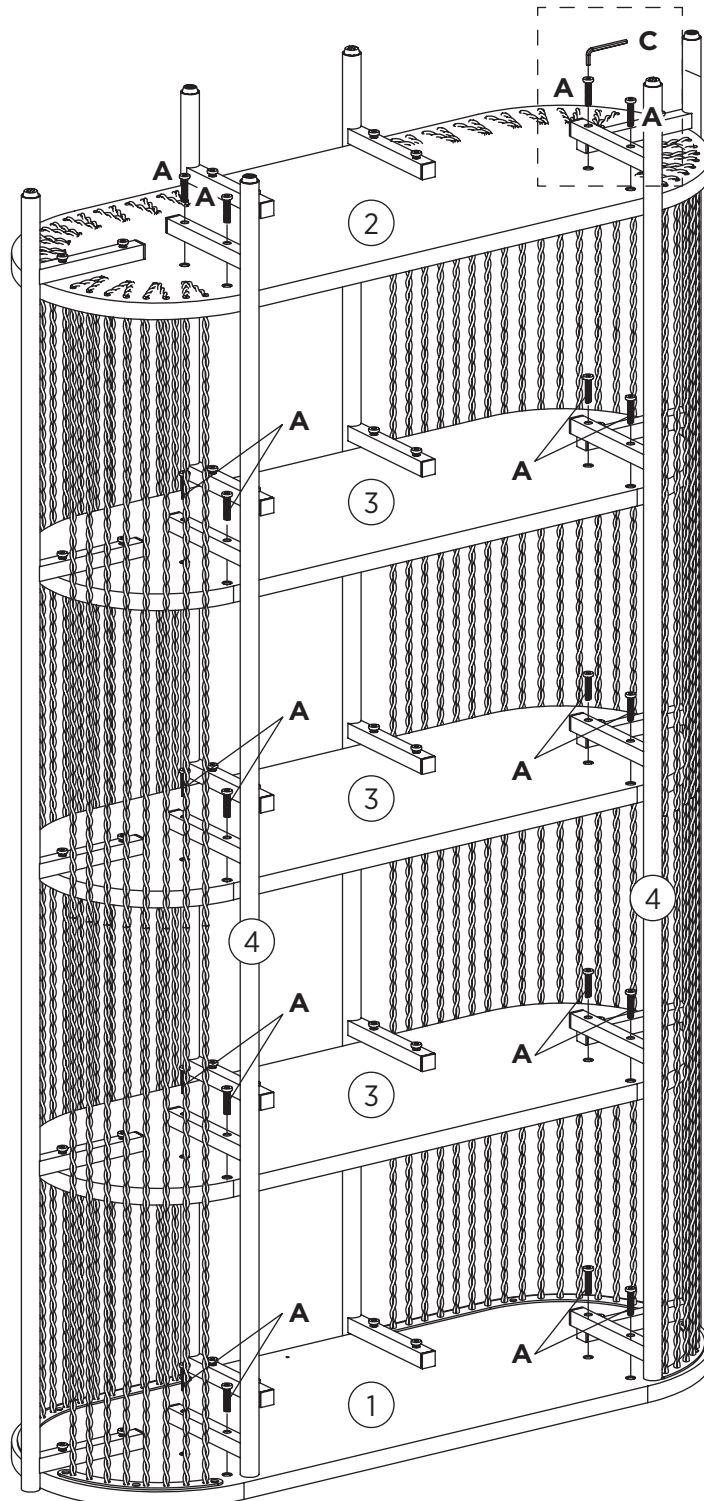
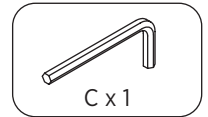
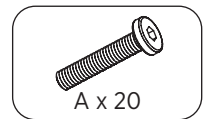

ASSEMBLY INSTRUCTIONS

STEP 5

Fix the metal plate of part 2 to part 1 using bolts (B) and allen key (C).



B x 12



C x 1

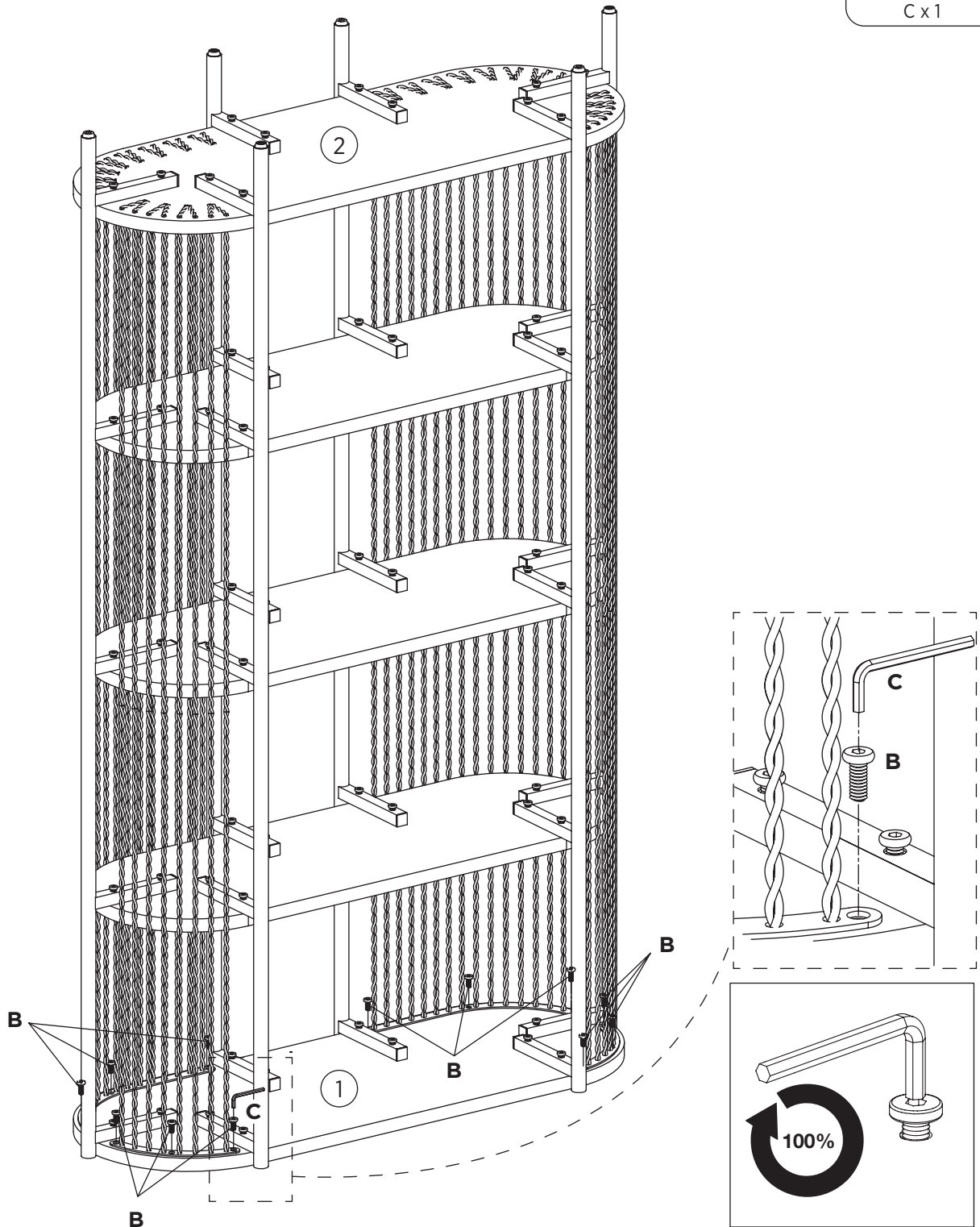

ASSEMBLY INSTRUCTIONS

STEP 6

Tighten all bolts using allen key (C).

Fix wall bracket (D) to part 1 using screw (E), as shown.

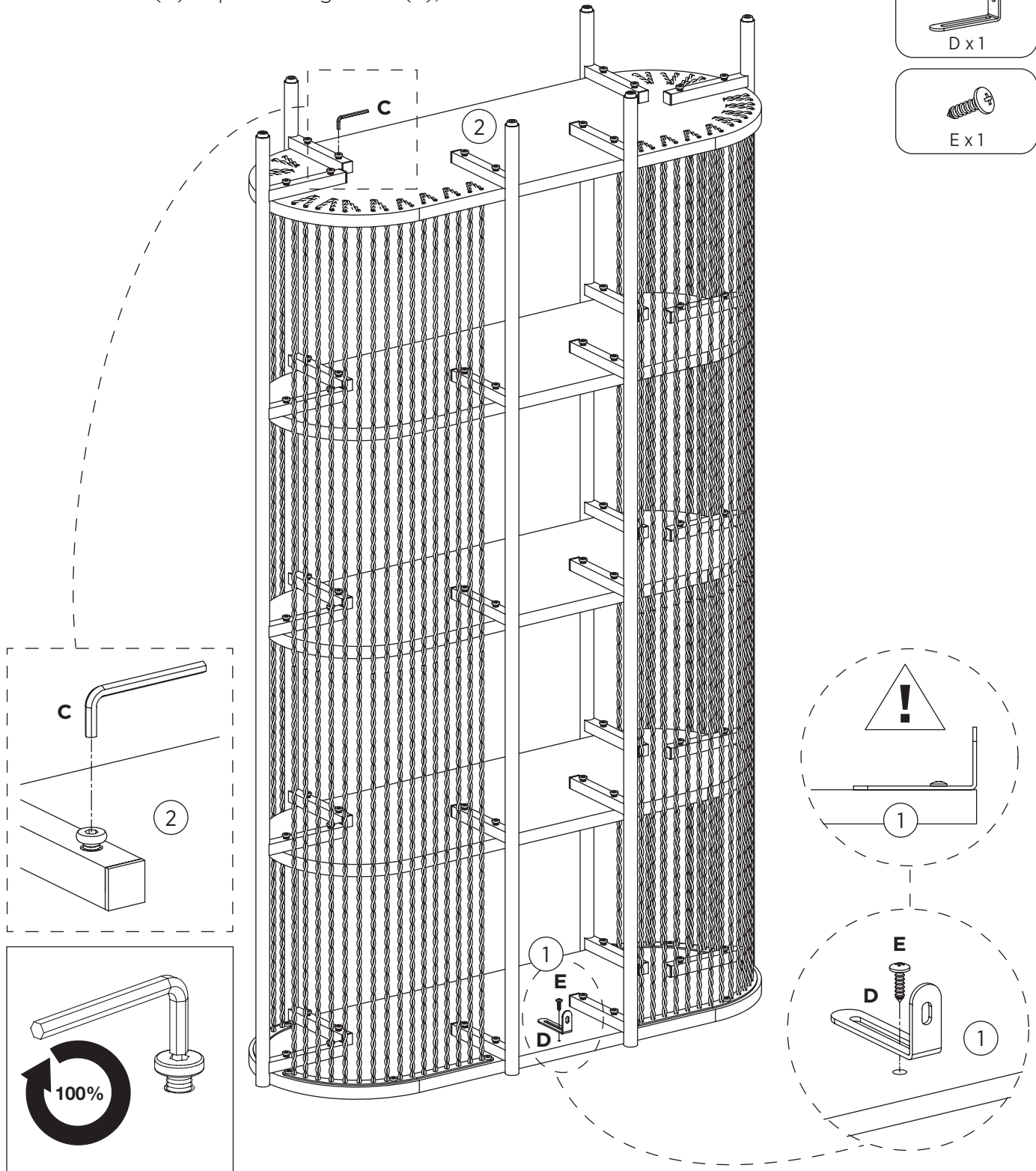
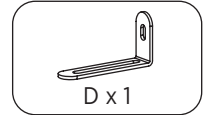
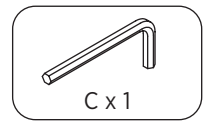

ASSEMBLY INSTRUCTIONS

STEP 7

**For extra stability, you must fix your bookcase to the wall using the additional hardware (F and G).
Screw (F) is fixed through the wall bracket (D) and into the wall plug (G), as shown.**

Should you choose not to affix the product to the wall, serious injury may be caused if the product tips over.

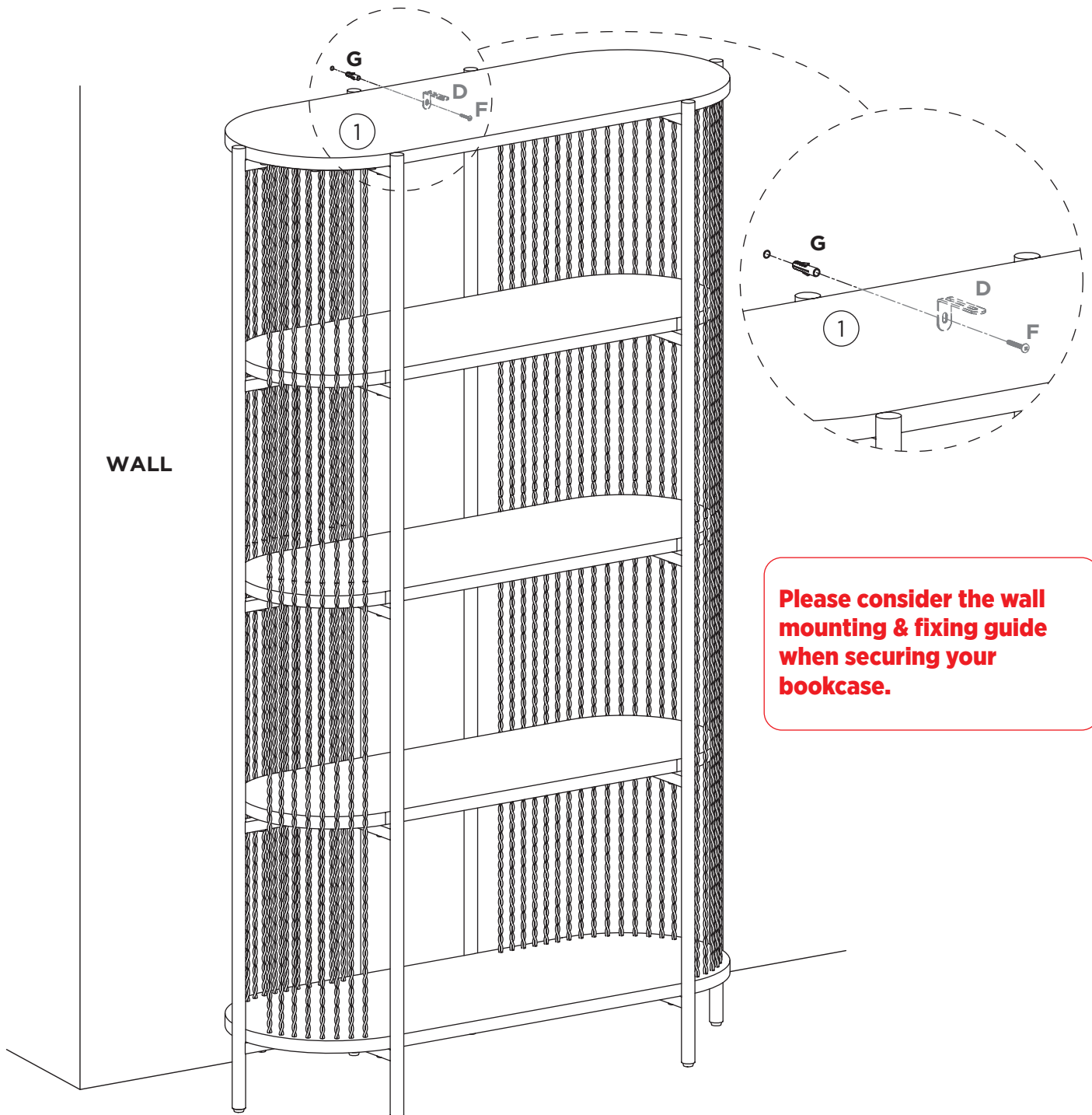
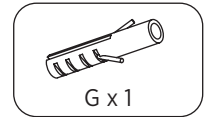
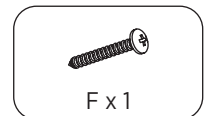

Please consider the wall mounting & fixing guide when securing your bookcase.

ASSEMBLY INSTRUCTIONS

STEP 8

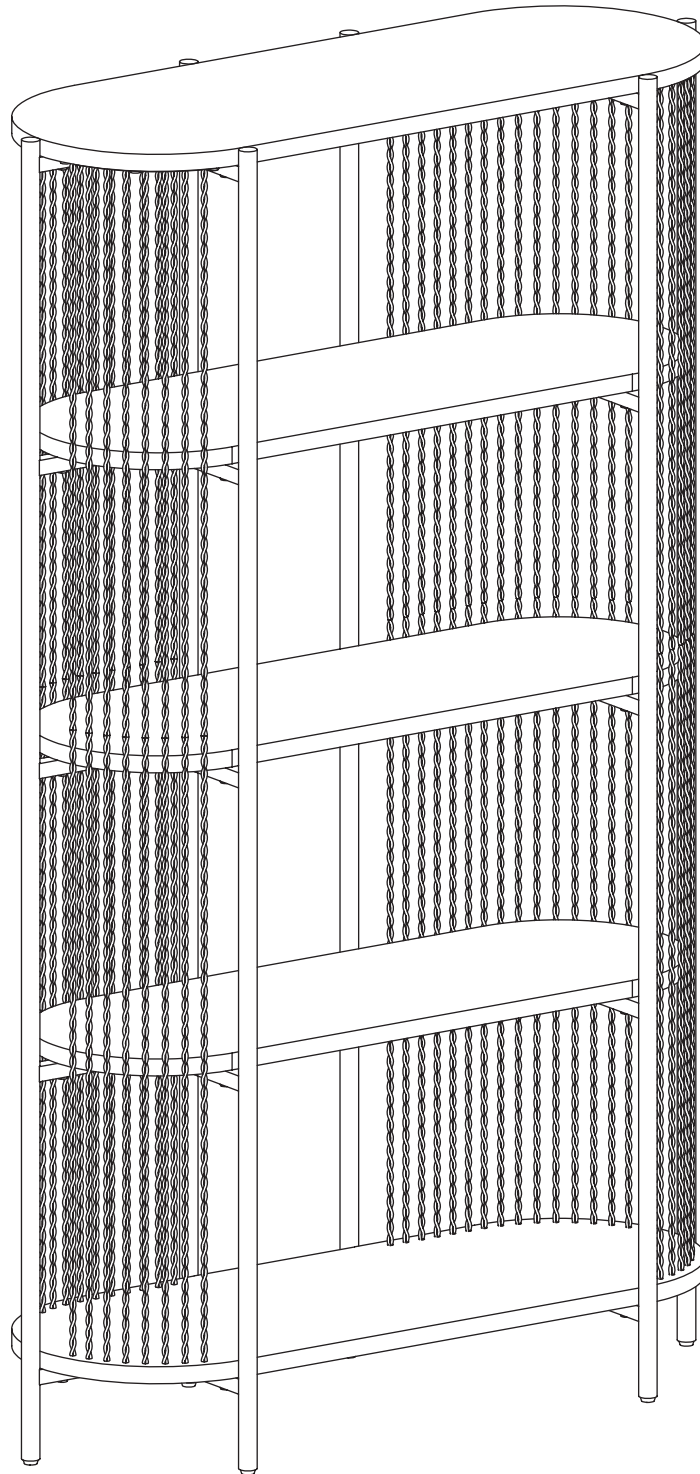

Please note: the maximum recommended weight is 10kg each shelf.

Your bookcase is ready for use.