

DINING TABLE ROUND

ASSEMBLY INSTRUCTIONS

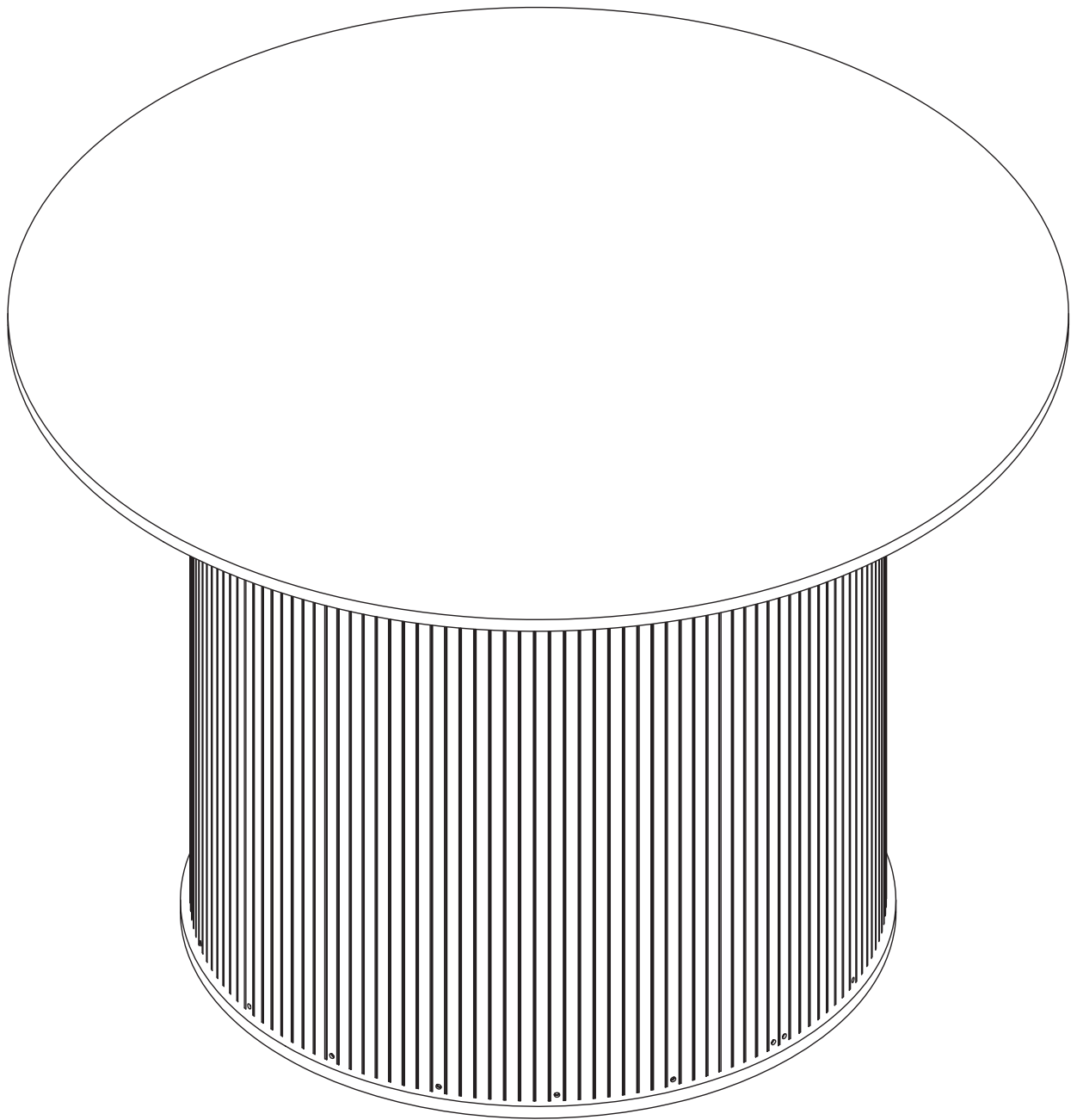

TIPS BEFORE YOU START

1. Please check that all parts are present before you start the assembly of your furniture.
2. For ease and speed of assembly, we recommend that before you commence each step of the assembly, that you identify all the parts required for that step.
3. For larger items, please ensure that you have sufficient space and people to assemble your product safely.
4. We recommend that, where possible, all items are assembled near to the area in which they will be placed in use, to avoid moving the product unnecessarily once assembled.
5. For the protection of your furniture, we recommend that the product is placed on a protected surface during assembly to prevent any damage.
6. During assembly please take care not to over-tighten any fittings, as this may damage the product. Do not use power tools.
7. Always place the product on a flat, steady and stable surface.
8. Do not stand on the product. Do not use the product as a stepladder.
9. This product is intended for indoor, household use only as it is a non-industrial product.
10. Please use caution and care when lifting the product to avoid personal injury and/or product damage.

CARE AND MAINTENANCE OF YOUR FURNITURE

- Please periodically check all fittings and re-tighten as necessary.
- To clean your item, please use a damp cloth and wipe clean.
- Never allow any kind of liquid to remain on your furniture. Absorption can cause wood to warp or finishes to de-laminate.
- Please do not place hot items (eg. hot drinks) directly on to the surface.
- Please do not drag and pull your furniture.

ASSEMBLY REQUIREMENTS

- Equipment: phillips head screwdriver, flat head screwdriver
- 1 x adult required
- 1.5m x 1.5m assembly space required
- 1.5 hour assembly time approx.

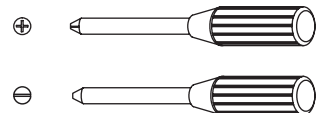

HARDWARE LIST

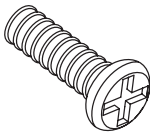

6 x A
Bolt

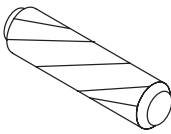

6 x B
Wooden Dowel

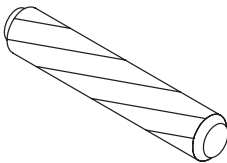

8 x C
Wooden Dowel

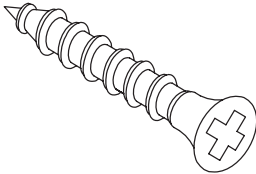

8 x D
Screw

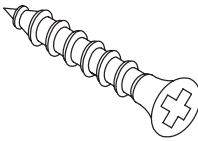

38 x E
Screw

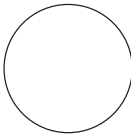

32 x F
Sticker

PARTS LIST

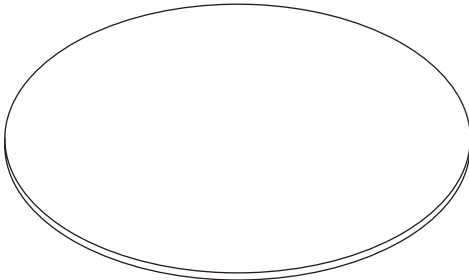

1
1 PC

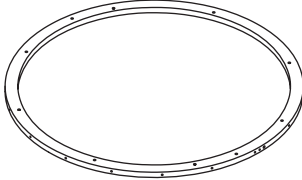

2
1 PC

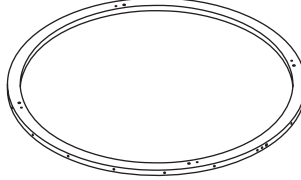

3
1 PC

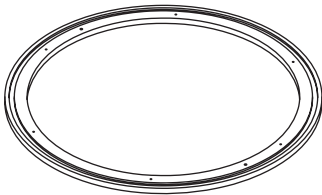

4
1 PC

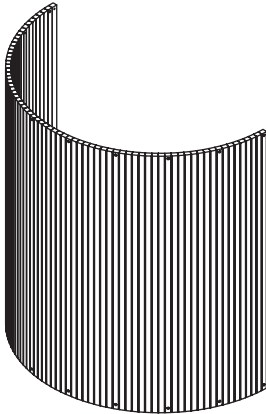

5
2 PCS



6
4 PCS

ASSEMBLY INSTRUCTIONS

STEP 1

Insert wooden dowels (C) to parts 6.

Fix parts 6 to parts 2 and 3 using screws (D), as shown.

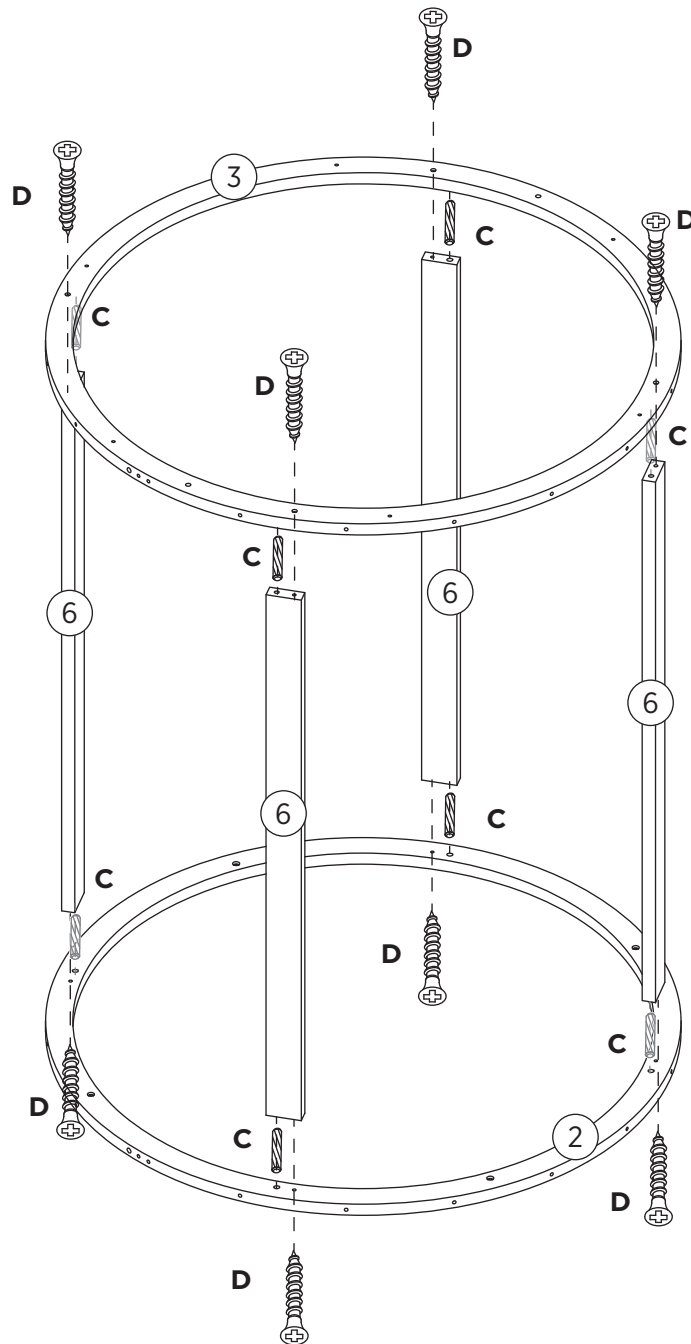
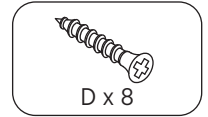
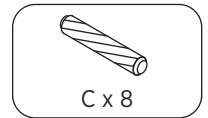

ASSEMBLY INSTRUCTIONS

STEP 2

Fix part 2 to part 1 using bolts (A), as shown.

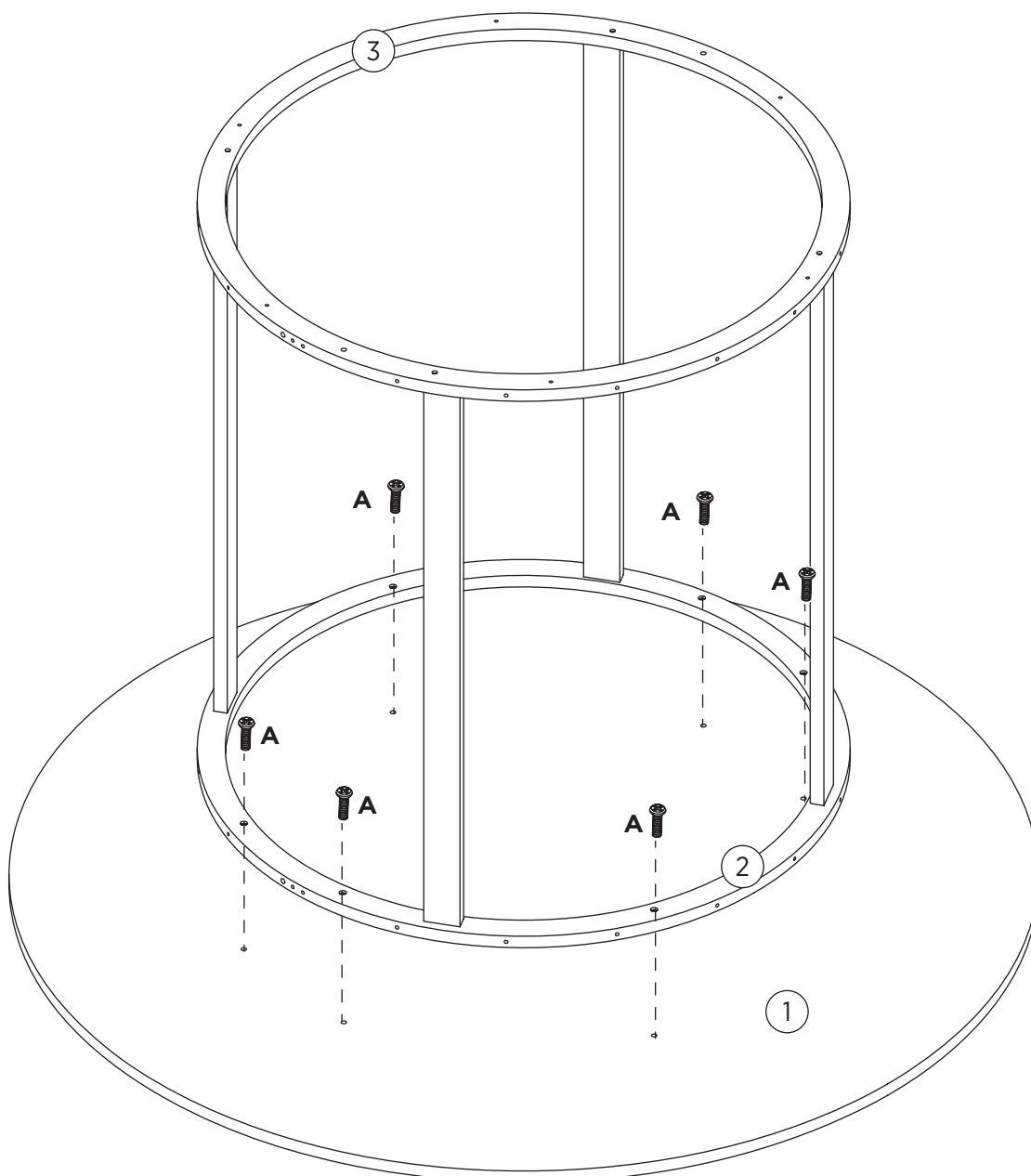
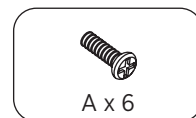

ASSEMBLY INSTRUCTIONS

STEP 3

Insert wooden dowels (B) to parts 2 and 3.

Fix part 5 to parts 2 and 3 using screws (E).

Attached sticker (F) to screws (E), as shown.

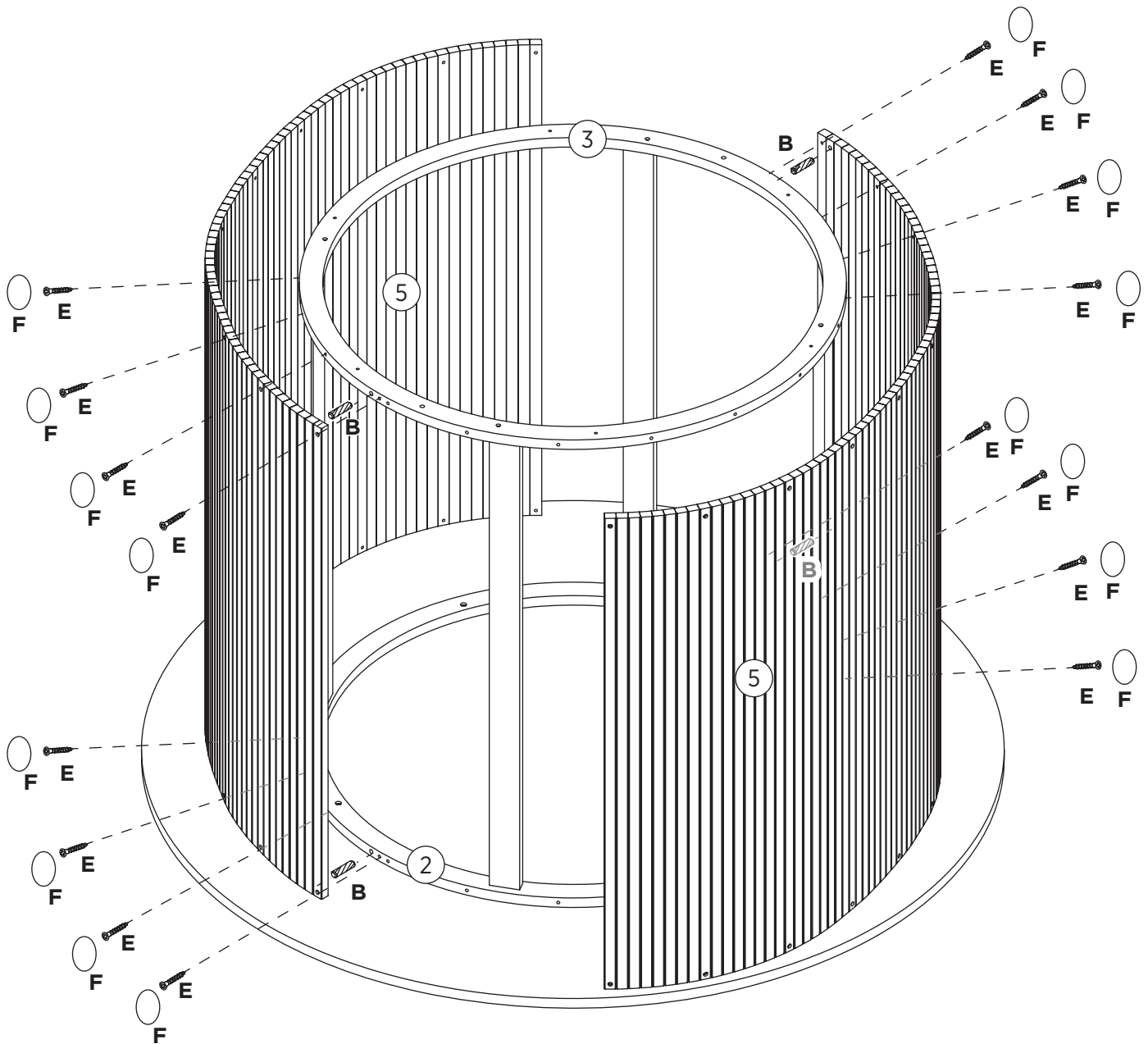
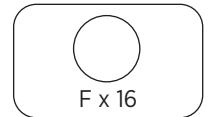
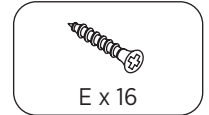
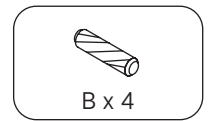

ASSEMBLY INSTRUCTIONS

STEP 4

Fix part 5 to parts 2 and 3 using screws (E)

Attached sticker (F) to screws (E), as shown.

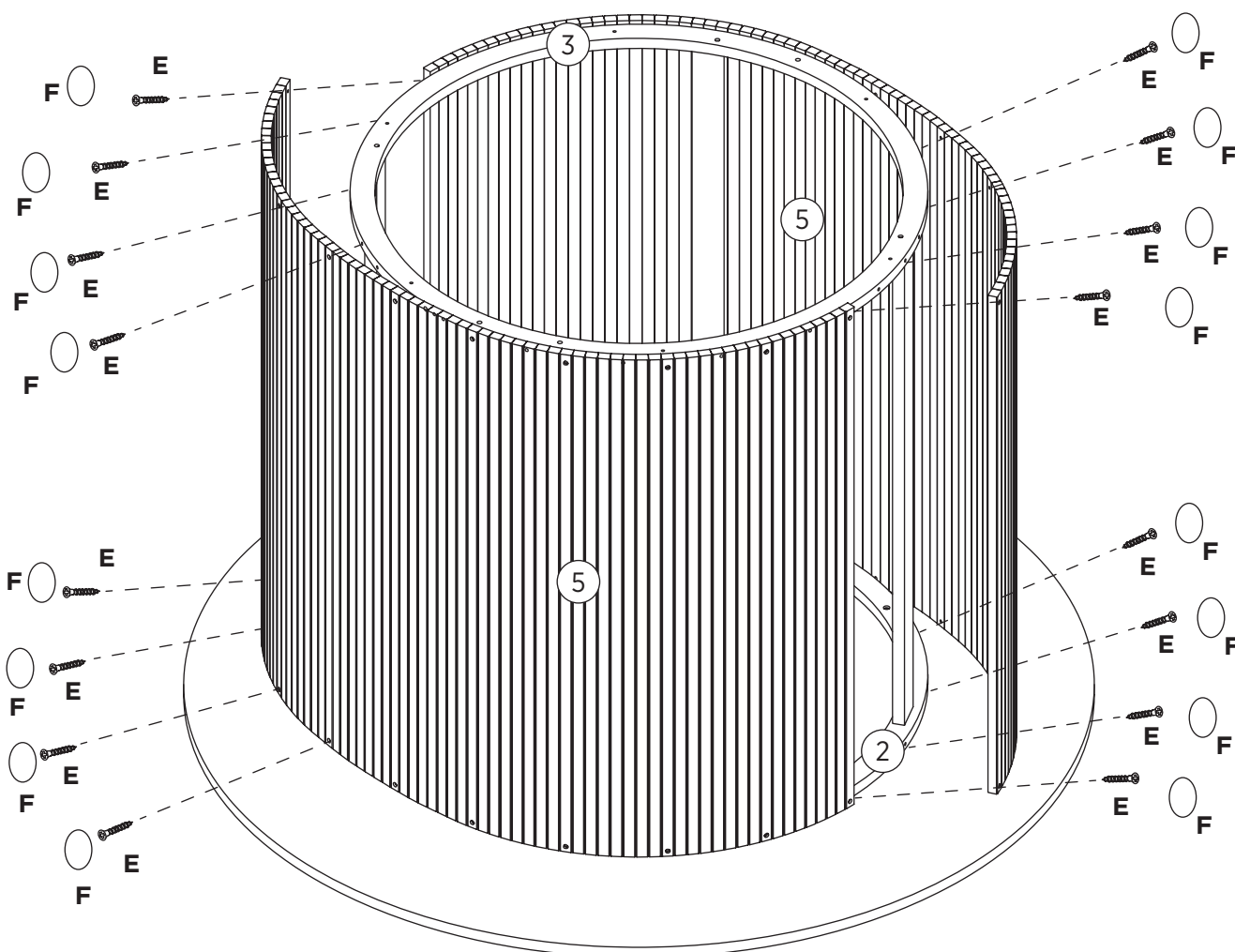
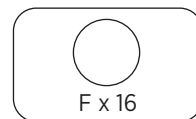
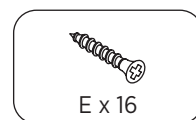

ASSEMBLY INSTRUCTIONS

STEP 5

Insert wooden dowels (B) to part 3.

Fix part 4 to part 3 using screws (E), as shown.

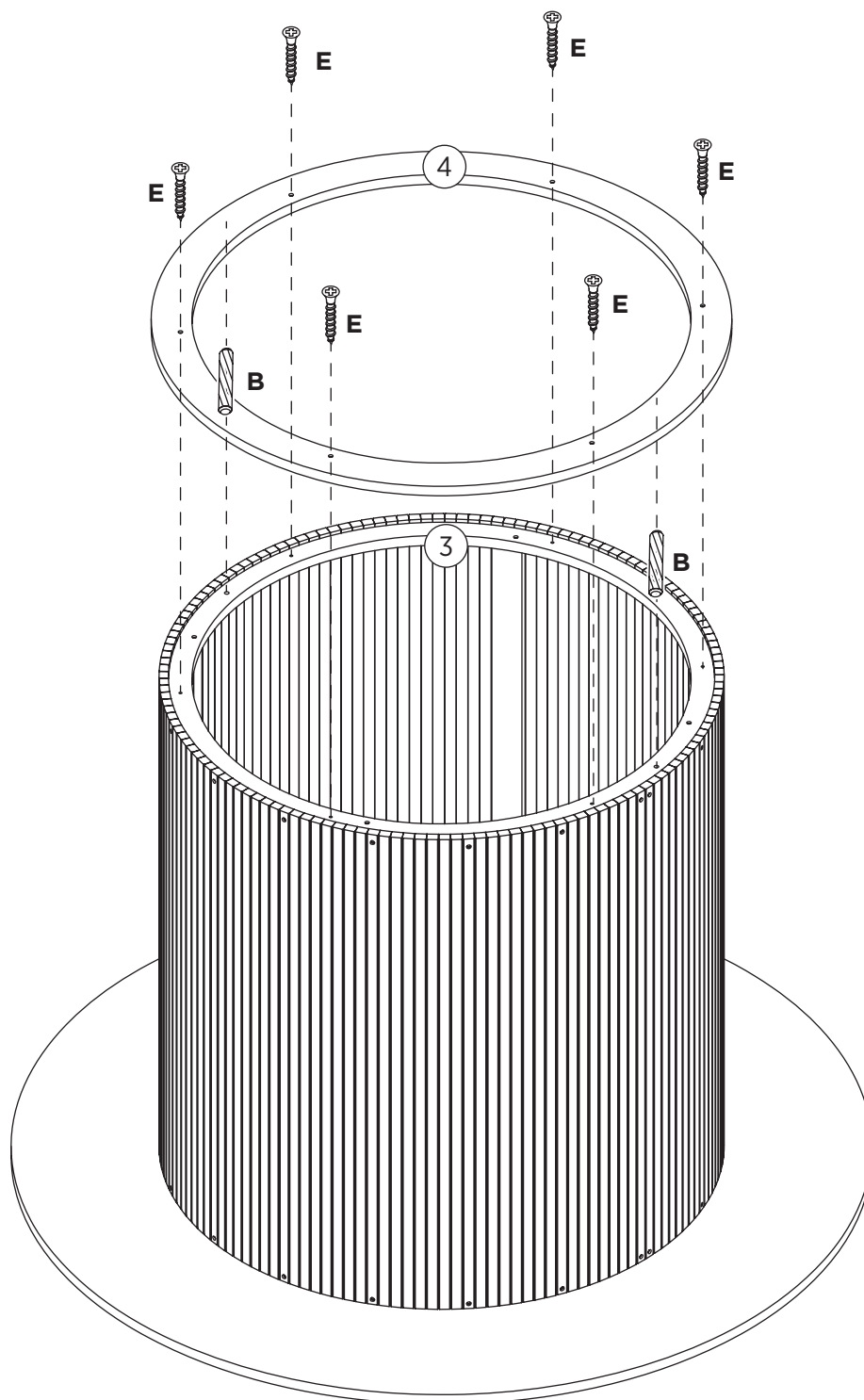
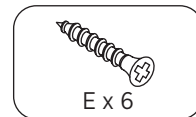
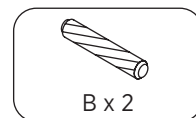

ASSEMBLY INSTRUCTIONS

STEP 6

Maximum recommended weight is 20kg.

Your dining table is ready for use.

