

HAMPTONS 1 DOOR WARDROBE

ITEM CODE: 5295R-WHT

1.5 HR

APPROXIMATE ASSEMBLY TIME



**2 PERSON
ASSEMBLY**

FLOOR AREA
2.0M X 2.0M

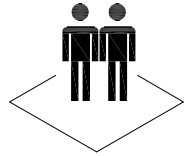

REQUIRED ASSEMBLY SPACE

REQUIRED ASSEMBLY TOOLS



POZI SCREWDRIVER

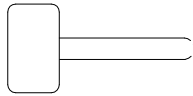

HAMMER

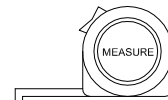

MEASURING TAPE



DRILL

ASSEMBLED DIMENSIONS

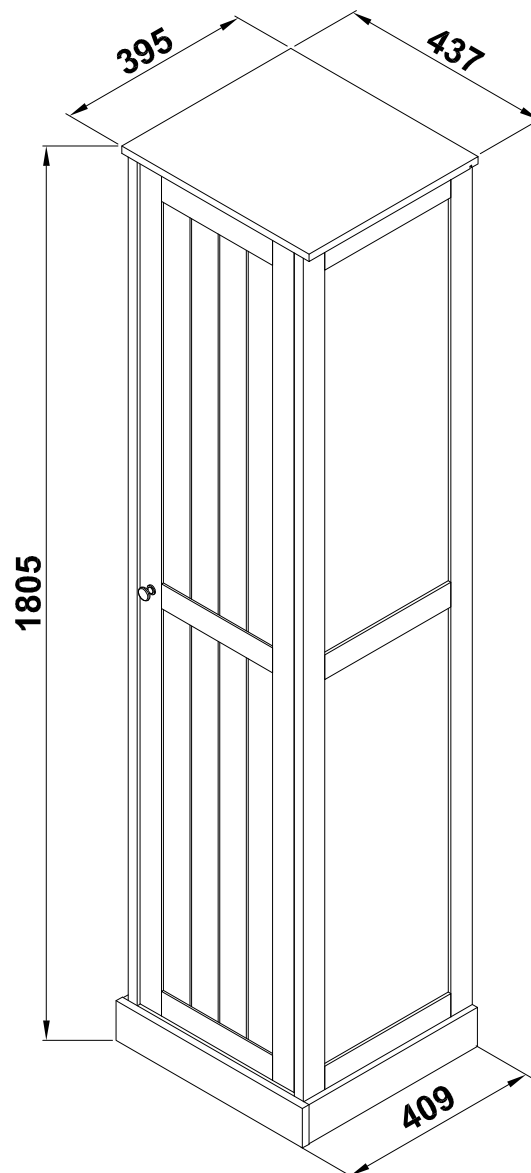

HAMPTONS 1 DOOR WARDROBE

ITEM CODE: 5295R-WHT

Important :

Please read these instructions carefully before use and keep for future reference.

- This product is intended for domestic use only and is not designed for commercial use.
- DO NOT assembly / use this item if any components are missing or damaged. Please contact the retailer straight away.
- DO NOT attempt to modify your item as this will void your warranty. Please call the retailer for required parts.
- Assembly to be carried out by a competent adult only.
- During assembly children should be kept away from the product due to possible risk of injury.

Please refer to separate Warranty Certificate for full warranty details and information.

Tips before you start :

- Please check that all parts are present before you start the assembly of your furniture. Please do not start to build your item if any parts are damaged as this may void your warranty. Please contact the retailer immediately so they can advise what you should do.
- For ease and speed of assembly, we recommend that before you commence each step of the assembly, that you identify all the parts required for that step.

HAMPTONS 1 DOOR WARDROBE

ITEM CODE: 5295R-WHT

Assembly Tips:

1. For larger items, please ensure that you have sufficient space and people (as indicated on page 1) to assemble your product safely.
2. We recommend that, where possible, all items are assembled near to the area in which they will be placed in use, to avoid moving the product unnecessarily once assembled.
3. For the protection of your furniture, we recommend that the product is placed on a protected surface during assembly to prevent any damage.
4. During assembly please take care not to over-tighten any fittings, as this may damage the product.
5. Always place the product on a flat, steady and stable surface.
6. Do not stand on the product. Do not use the product as a stepladder.
7. This product is intended for indoor, household use only as it is a non-industrial product.
8. Use of power tools is NOT recommended for assembling this product as over-tightening may occur and damage the product.
9. Due to the laminated finish of this item and the materials used to construct it, when first opening the carton and assembling a slight smell may be noticeable. This will dissipate over a short period of time. Please contact the retailer you purchased this item from if you have any concerns.
10. Please use caution and care when lifting the product to avoid personal injury and / or damage.

Care and Maintenance of your Furniture

- Please periodically check all fittings and re-tighten as necessary.
- To clean your item, please use a damp cloth and wipe clean. Never use harsh chemicals or strong detergents as this could damage the finish of your product.
- Never allow any kind of liquid to remain on your furniture. Absorption can cause wood to warp or finishes to de-laminate.
- Please do not place hot / cold items (e.g. hot drinks) directly on to the surface.
- Do not pull or drag your item. Ensure it is evenly supported and lifted while moving it.
- Avoid placing sharp objects on the surface as this may scratch the surface. It is recommended to use trivets or coasters under flowerpots, vases, mugs etc to avoid damage to your item.

HAMPTONS 1 DOOR WARDROBE

ITEM CODE: 5295R-WHT

Tips before you start:

QUICKFIT

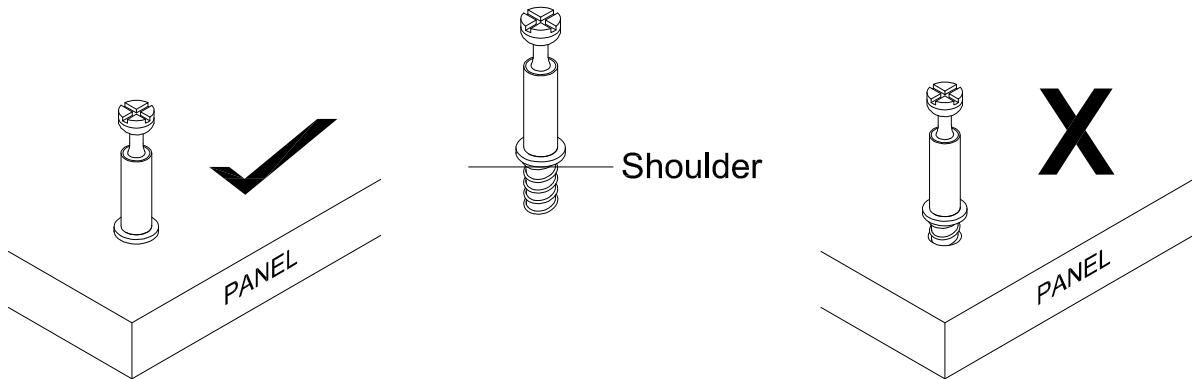

Tighten quickfit until shoulder is flush with panel. Do not overtighten or undertighten.

CAM LOCK

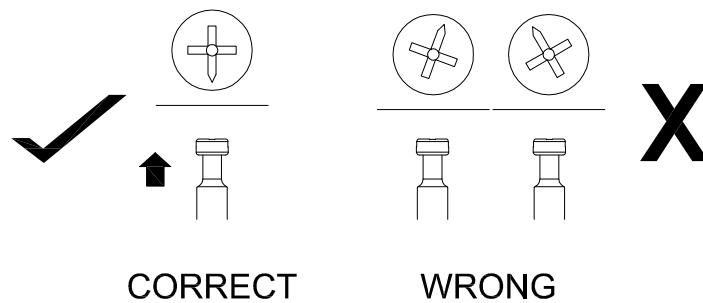

When fitting cam lock, ensure starting position is correct before you insert connecting quickfit.

Quickfit head should be in the centre of the cam lock when the two panels are joined.

Cam lock should be inserted before quickfit.

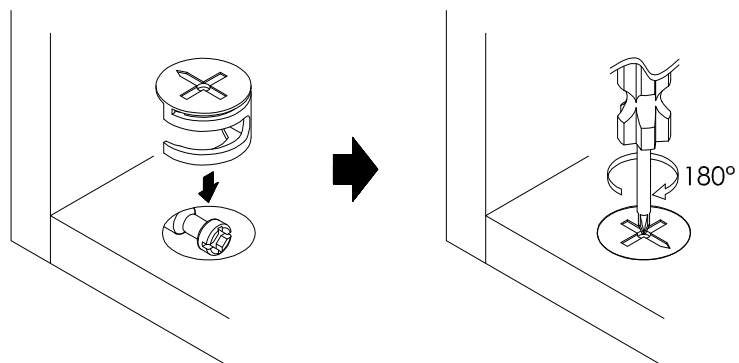

Turn camlock clockwise to tighten.

HAMPTONS 1 DOOR WARDROBE

ITEM CODE: 5295R-WHT

PART LIST:

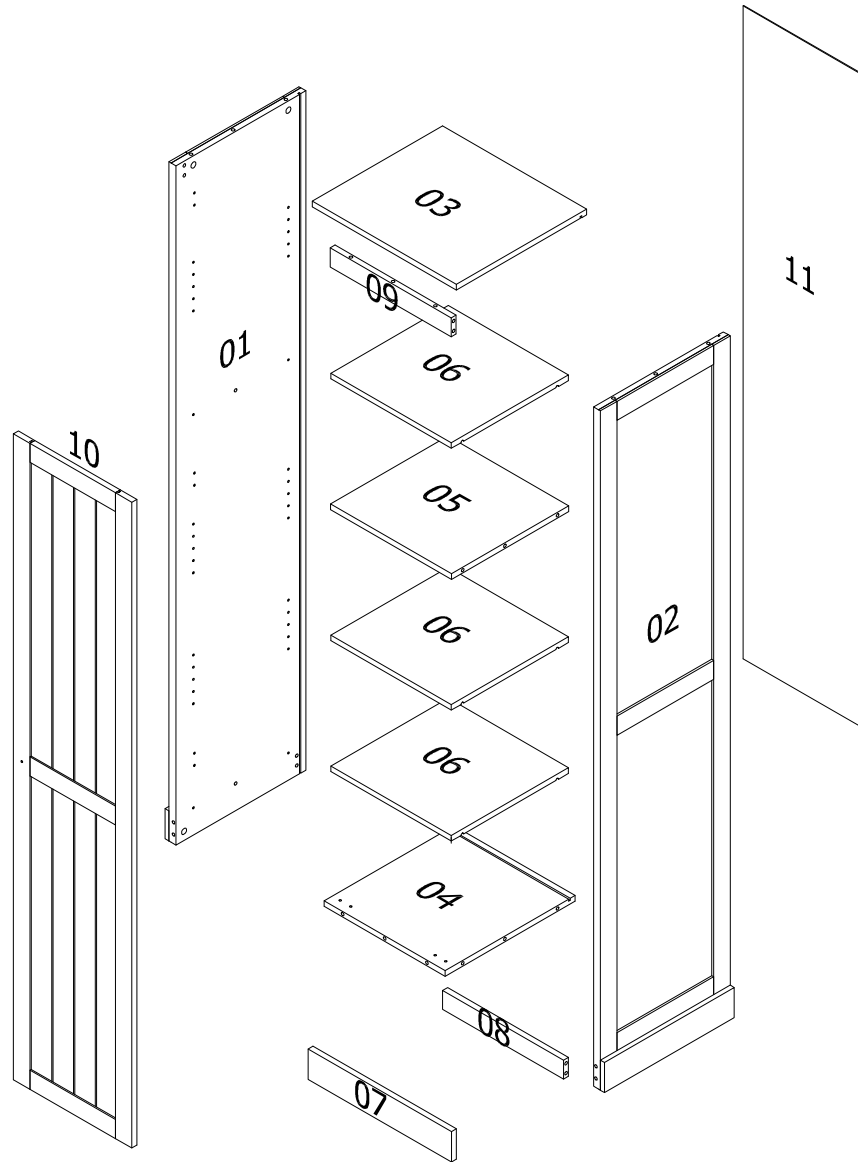











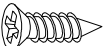

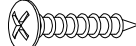
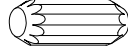
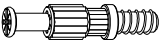
NO.	PART NAME	QTY
1	SIDE PANEL (LEFT)	1
2	SIDE PANEL (RIGHT)	1
3	TOP PANEL	1
4	BOTTOM PANEL	1
5	SHELF PANEL	1
6	ADJUSTABLE SHELF PANEL	3

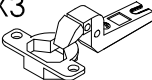
NO.	PART NAME	QTY
7	FRONT PANEL (BOTTOM)	1
8	BOTTOM SUPPORT RAIL	1
9	FRONT PANEL (TOP)	1
10	DOOR PANEL	1
11	BACK PANEL	1

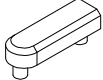
HAMPTONS 1 DOOR WARDROBE

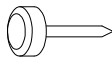
ITEM CODE: 5295R-WHT

HARDWARE LIST

A X14  CSK SCREW M3.5 X 15MM	B X6  EURO SCREW M6 X 13MM	C X1  TH CB SCREW M4 X 16MM (RB)	D X20  WOOD DOWEL Ø8 X 25MM
E X16  9047975 BOLT DOWEL DU319 20X5MM	F X16  9064684 CAM 15/15	G1 X3  METAL HINGES (7/8") W/ SPRING	G2 X3  HINGES PLATE
H X1  PLASTIC DOOR STOPPER	J X1  METAL KNOB 702-25= (1PC) WITH SCREW (MC4 X 22MM)=(1PC)	K X4  PLASTIC LEG STUD	L X12  METAL ADJUSTABLE SHELF STUD
M X8  BACKPLY STOPPER	N X1  PP STRAP 12 X 150 X 1.2MM BLK 2 HOLE WITH EYELET		

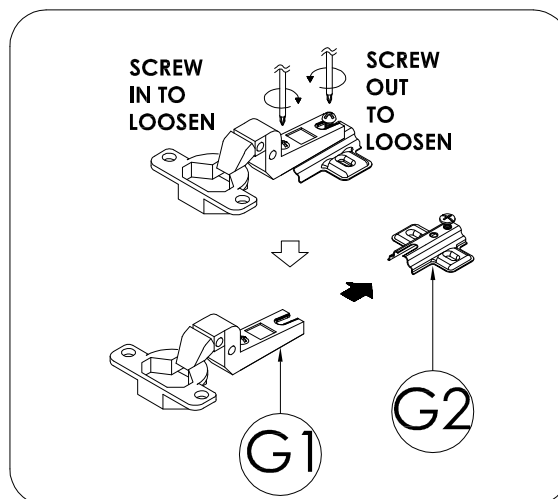

G1 & G2

NOTE: Before you begin assembly please ensure you have separated the hinges to give you part #G1 and # G2.

HAMPTONS 1 DOOR WARDROBE

ITEM CODE: 5295R-WHT

STEP 1

Insert dowel (D) into panels (1, 2, 4, 5, 8 & 9) as shown.

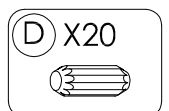
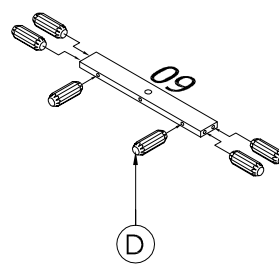
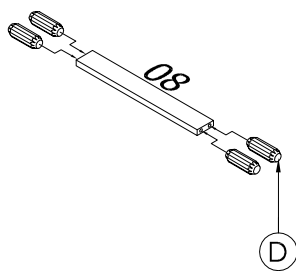
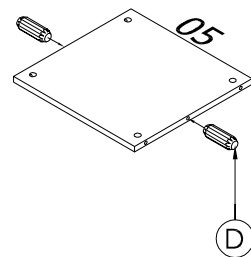
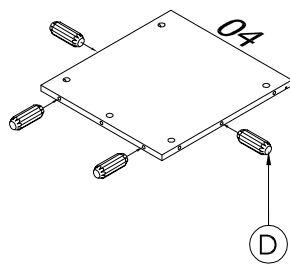
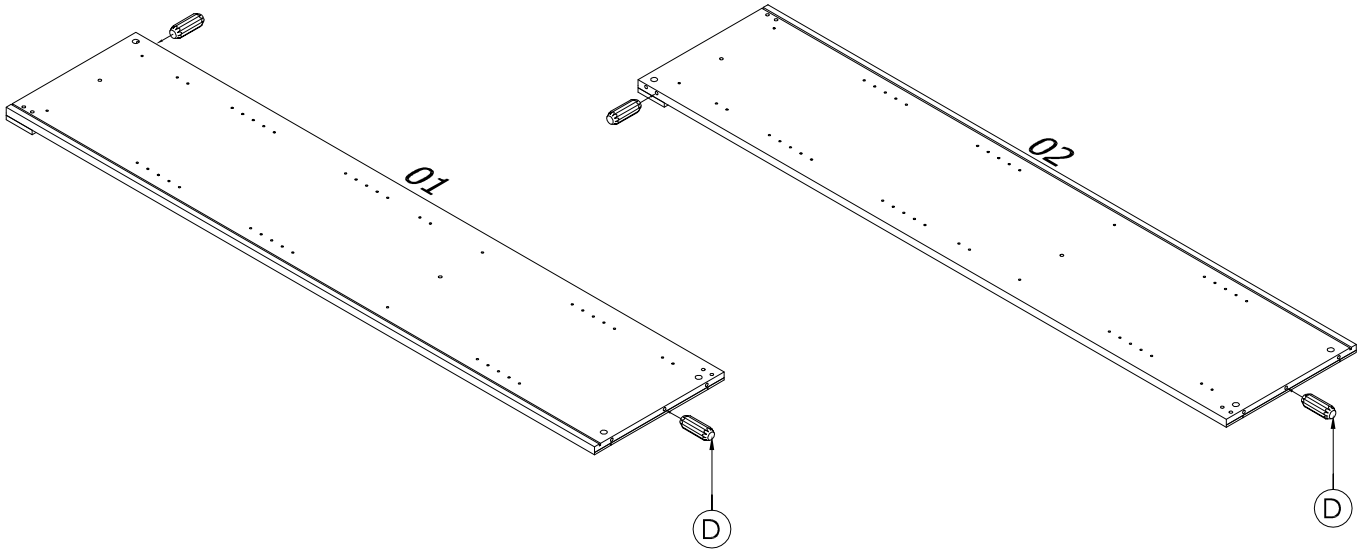

HAMPTONS 1 DOOR WARDROBE

ITEM CODE: 5295R-WHT

STEP 2

Take all panels (1, 2, 3 & 7), using a drill on low speed / torque or a phillips head screw driver CAM PINS (E) as shown. Attach hinges plate (G2) to panel (2) using screw (B) as shown.

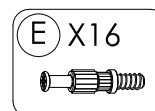
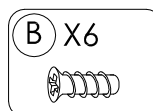
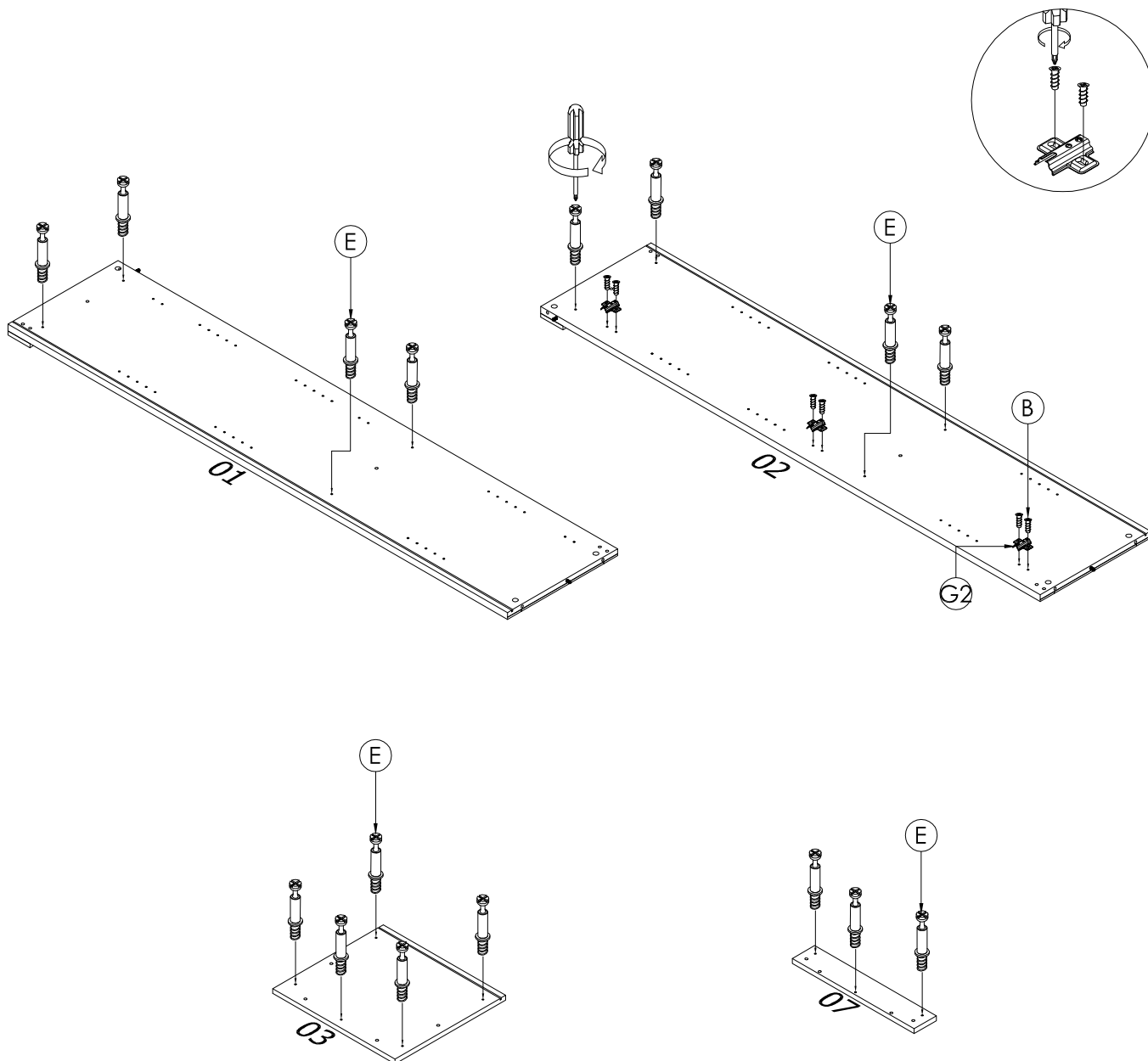

HAMPTONS 1 DOOR WARDROBE

ITEM CODE: 5295R-WHT

STEP 3

Attach panel (1 & 2) to panels (4, 5, 8 & 9) using CAM LOCKS (F) as shown.

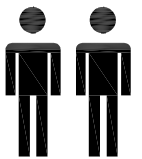
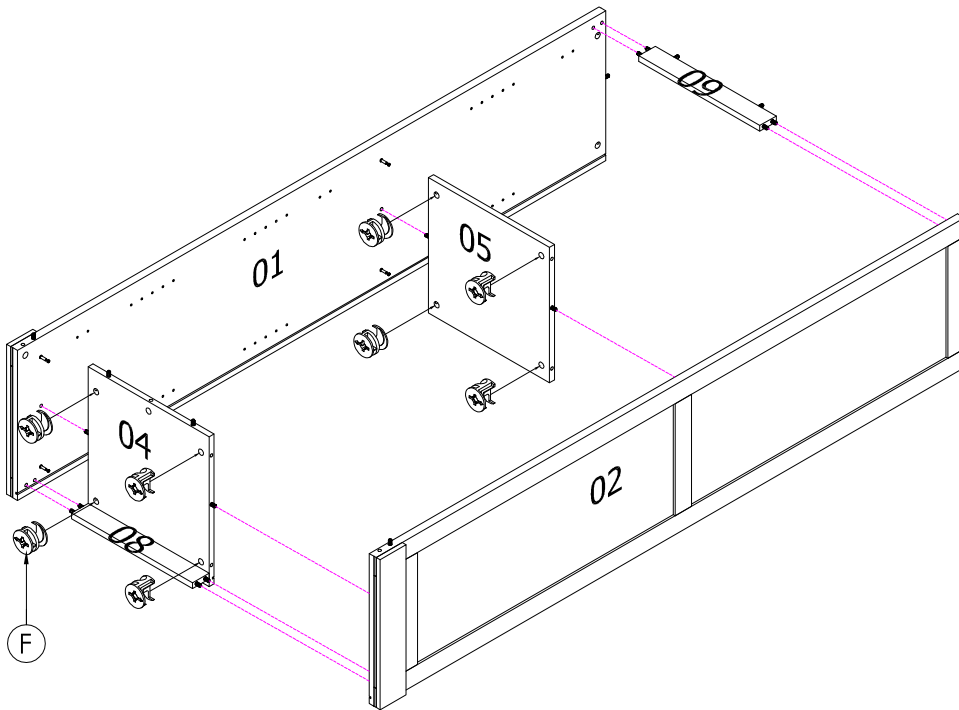

2 PERSON

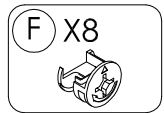

STEP 4

Attach panel (7) to panels (1, 2 & 4) with CAM LOCKS (F), then attach plastic leg stud (K) below panel (1 & 2) as shown.

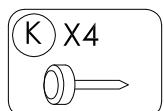
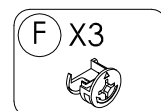
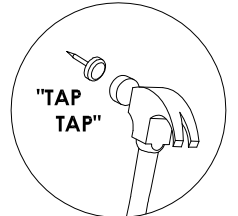
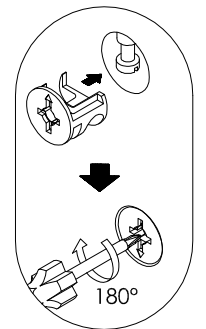
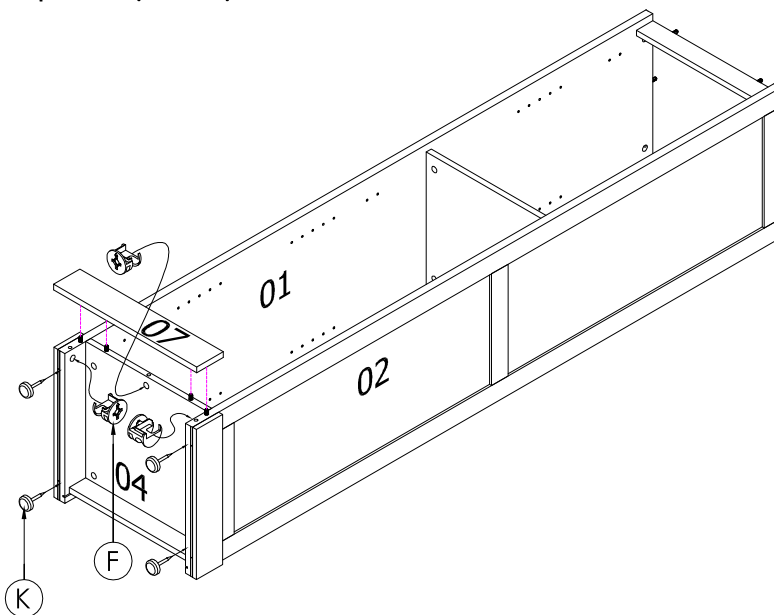

HAMPTONS 1 DOOR WARDROBE

ITEM CODE: 5295R-WHT

STEP 5

Slot back panel (11) to frame. Then attach door stopper (H) to panel (4).

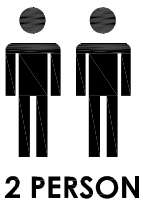
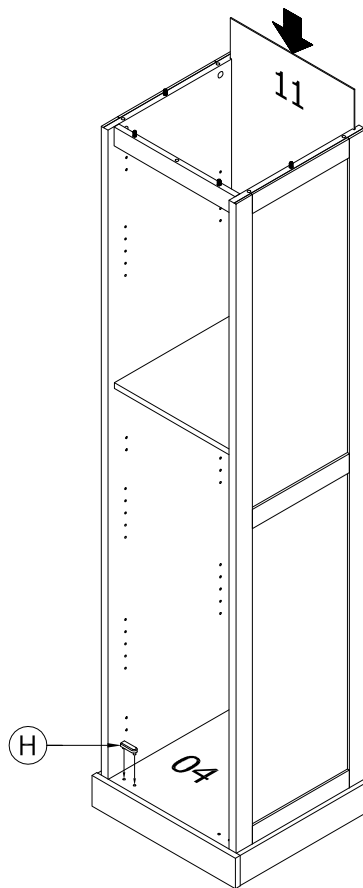
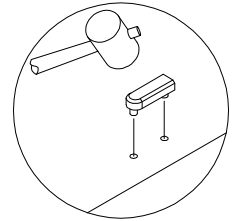

Note: Always use atleast 2 adults to stand the item upright

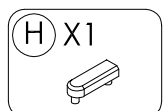

HAMPTONS 1 DOOR WARDROBE

ITEM CODE: 5295R-WHT

STEP 6

Attach top panel (3) to body frame. Fasten into place using CAM LOCKS (F) as shown.

Note: Please always ensure cam's are correctly locked to secure and support your item. Refer to Camlock guidelines at the beginning of this manual for further information.

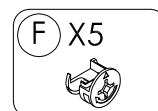
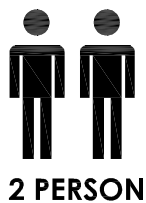
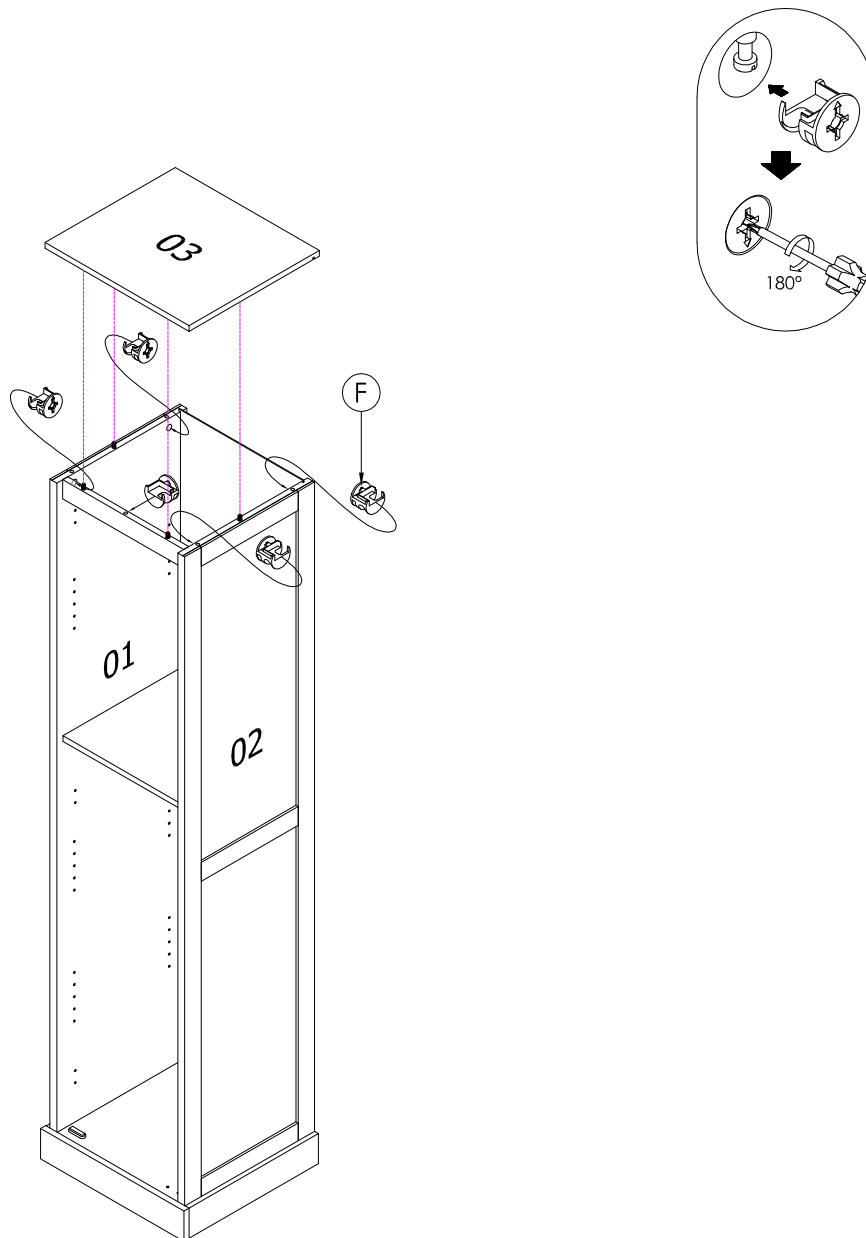

HAMPTONS 1 DOOR WARDROBE

ITEM CODE: 5295R-WHT

STEP 7

Slot the shelf panel (6) into the body after fix in the metal adjustable shelf stud (L) on the holes as shown.

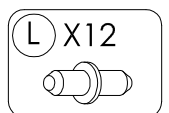
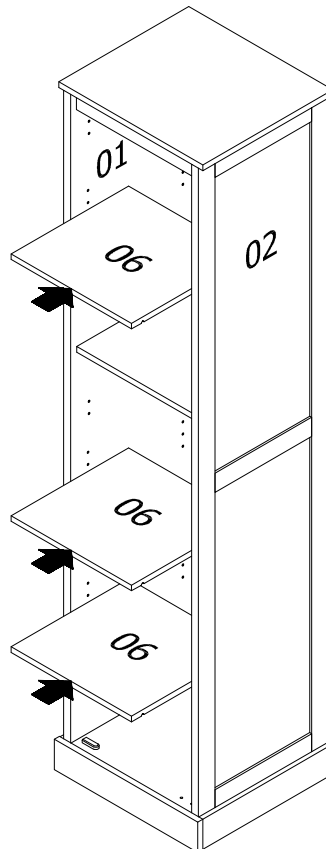
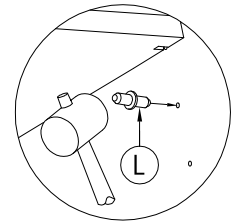

STEP 8

Attach hinges (G1) to door panel (10) using screw (A) as shown.

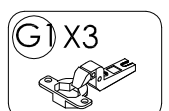
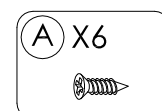
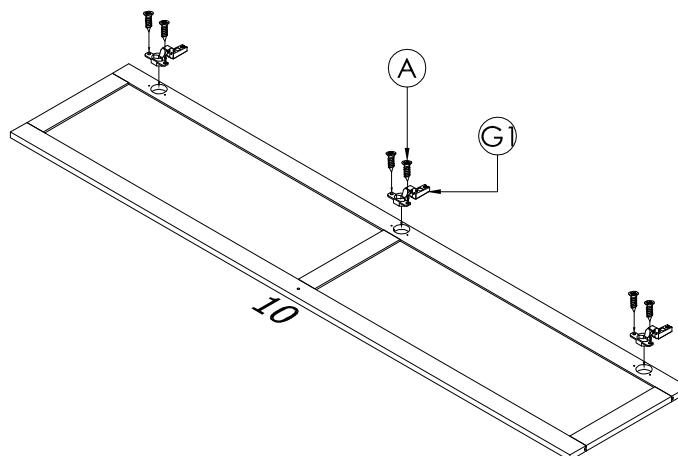
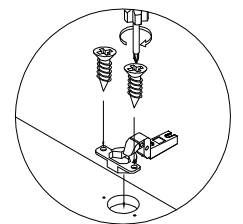

HAMPTONS 1 DOOR WARDROBE

ITEM CODE: 5295R-WHT

Hinge Installation Guideline

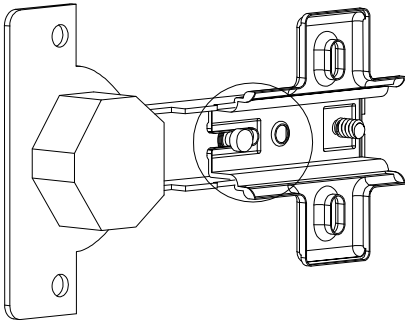

Image shows underside of hinge

STEP 1 - The hinge will arrive connected to the hinge plate.

Take note of the placement of this hinge, this is how it needs to be assembled when you align the door with the hinge plate during building process. (circle)

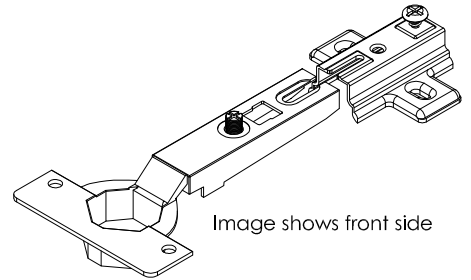

Image shows front side

STEP 2 - Take a part the hinges as shown in the Instructions so that you end up with the door hinge and hinge plate.

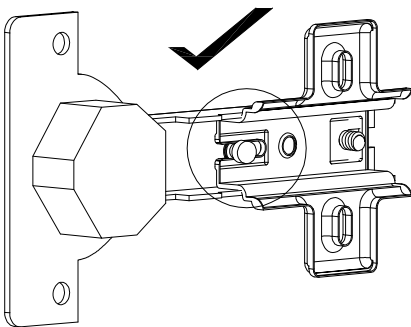

Image shows underside of hinge. You can see the middle pin is locked into its position. (circle)

STEP 3 - During installation, when the step requires you to attach the door to the hinge plate on the product please ensure the hinge slides over the hinge plate so the middle pin (circle) slides into the designed slot and locks the hinge in place.

It may be hard to tell if it is in place correctly due to the door being in the way. You could try and gently pull the hinge off the plate. If its locked in it wont move freely.

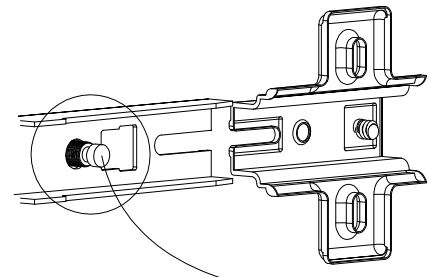
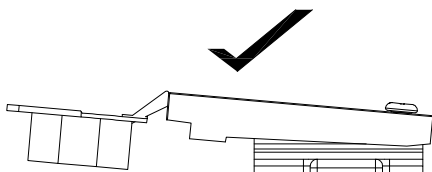

Image shows underside of hinge. You can see the middle pin clearly. (circle)



STEP 4 - Once you are confident the middle pin is locked into position you can use the screw provided to join the door hinge and the hinge plate together and start the alignment process.

Please refer to the instruction for guidelines on how to adjust the hinges so that your doors align nicely.

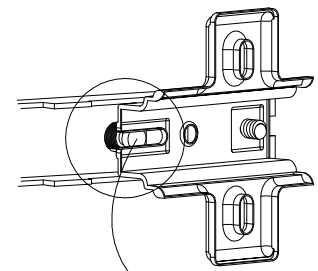
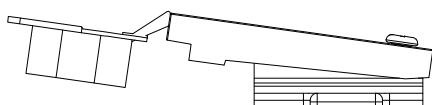
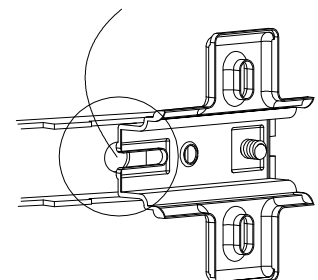

Image shows underside of hinge. You can see the middle pin is not locked into its position. (circle)

X



As per the image below the door hinge should sit nice and flat onto the hinge plate. If its raised (as shown below) then it hasn't correctly locked into position.



HAMPTONS 1 DOOR WARDROBE

ITEM CODE: 5295R-WHT

STEP 9

Attach the handle (J) to door panel (10). Then attach the door panel (10) to side panel (2).

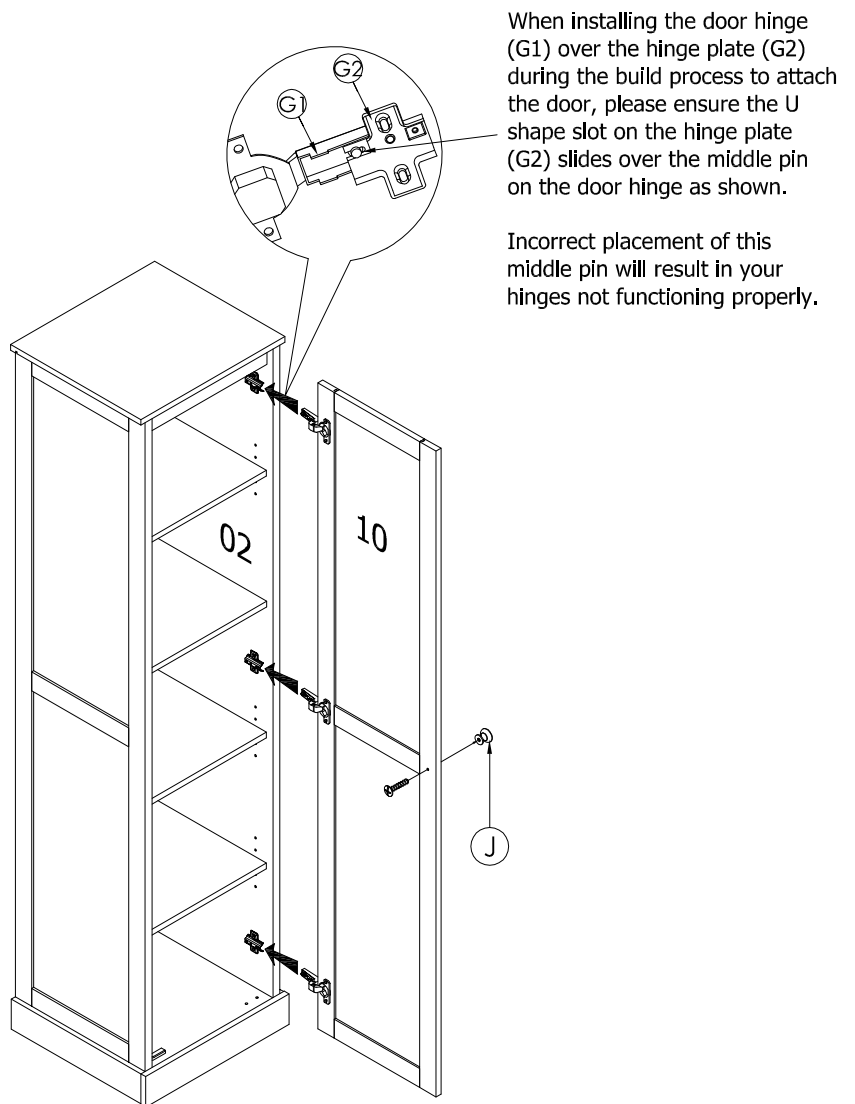
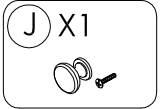

NOTE :

Before you complete Step 9, its best to tighten the "hinge plates" on panel 1 and 2 to ensure they are pushed in as far as they can, so when the door is attached they wont come loose. To successfully do this, please place your hand on the outside of the panel 1 and 2 so that you can push your hand inward against the panel as you screw in the hinge plate. Please make sure the screw grabs the side panel the entire way. It can take abit of pressure to successfully do this. You should notice that the hinge plate on these panels 1 and 2 will then sit flash with the panels and there should be no gaps between the plate and the side panel.

HAMPTONS 1 DOOR WARDROBE

ITEM CODE: 5295R-WHT

HOW TO ADJUST YOUR HINGES AND ALIGN THE DOORS

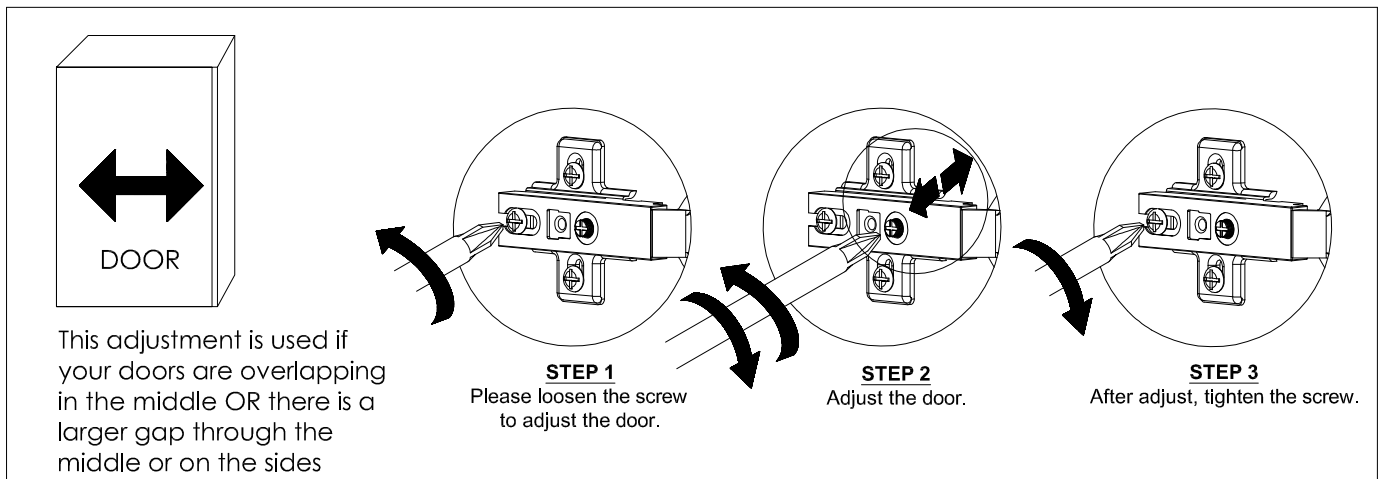

Follow the adjustments and make sure the middle pin is correctly installed as per previous instructions. If the middle pin isn't correctly installed then this adjustment will not work correctly.

If you tighten/loosen this screw it will adjust the doors to the left/right.

This step usually takes small adjustments and then closing doors to see if the gaps have evened out. Sometimes just half a turn of the screw can make a big impact to the gap.

The hinges are correctly installed and in position once you have a nice straight gap down the sides of the cupboard between the door and the side of the cupboard cavity.

HAMPTONS 1 DOOR WARDROBE

ITEM CODE: 5295R-WHT

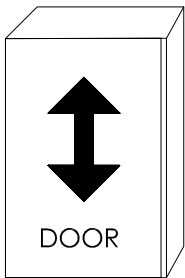

This adjustment is used if your doors have a big gap at the top or the bottom, or if one door sits straight but is lower than the other door.

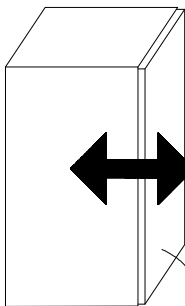
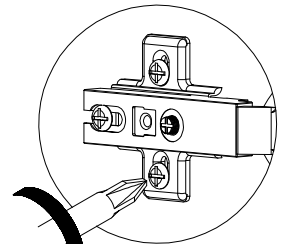
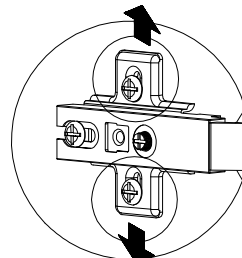
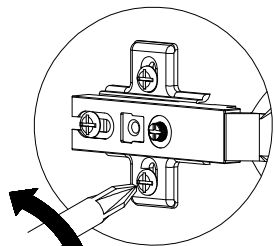

This adjustment is used if your doors are TOO CLOSE to the main cavity. You can loosen the screw and then move the door hinge closer or further out depending on the outcome you want to achieve

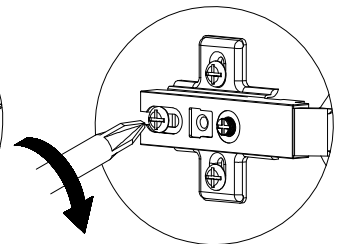
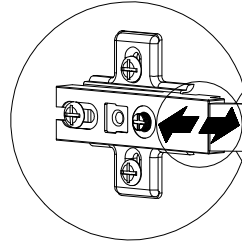
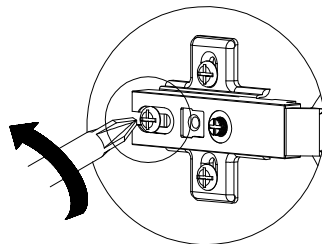

HAMPTONS 1 DOOR WARDROBE

ITEM CODE: 5295R-WHT

STEP 10

Attach backply stopper (M) to the back panel (11) using 15mm screw (A). Then attach pp strap (N) to top panel (3) with 16mm screw (C) as shown.

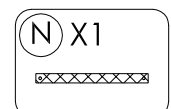
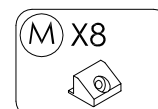
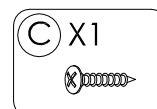
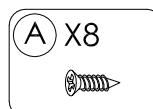
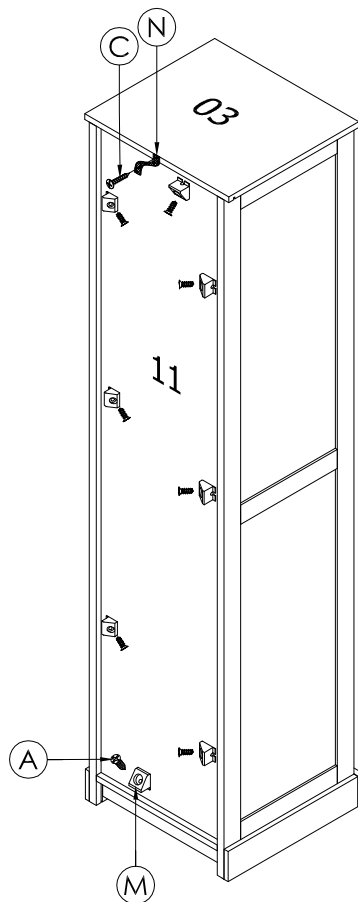
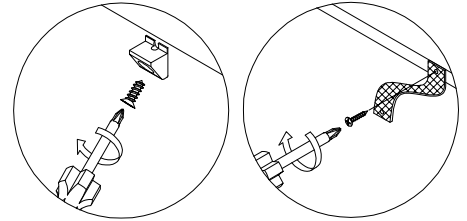

HAMPTONS 1 DOOR WARDROBE

ITEM CODE: 5295R-WHT

ASSEMBLY IS COMPLETE



WARNING

Serious or fatal crushing can occur from furniture tip over. To help prevent tip over :

- Install all tip over restraints provided with your product.
- Place heaviest item inside the lower doors.
- Do not sit TV 's or other heavy objects on top of this product.
- Never allow children to climb or hang on drawers, doors, shelves.
- Never open more than one door at a time.

Use a tip over restraints may only reduce, but will not eliminate, the risk of tip over.

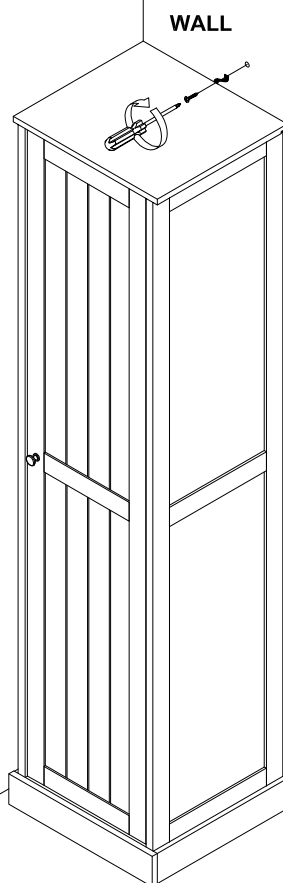

WARNING :

ENSURE THAT WALL STRAP IS ATTACHED TO AVOID SERIOUS INJURY

To avoid any serious injury, this product has been supplied with a wall strap to prevent toppling.

We strongly recommend that this product is permanently fixed to the wall or other suitable surface.

Wall fixing hardware is not supplied as different surface materials require different attachments. Please seek professional advice if you are in doubt of what fixing should be use.

Wall fixings can be purchased from your local hardware store.

Wall Mounting & Fixing Guide

NOTE: Supplied wall plugs are only suitable for use in masonry walls.

If you have any doubts about using the correct plug for your wall, please seek professional advice.

Failure of the product due to using incorrect fixings is the responsibility of the installer.



IMPORTANT:

When drilling into walls, always check for hidden wires or pipes, etc.



Tips & Tricks

Make sure that the hardware used is suitable for supporting your unit.

Please consult a qualified tradesperson if unsure.

- If you are unsure, please select a larger screw and wall plug.
- Ensure that you use the recommended drill bit to match the wall plug and hole size.
- Take extra care when drilling high walls, ceiling and ceramic tiles. Ensure wall plugs are inserted beyond the thickness of the ceramic tiles to avoid splitting or cracking.
- Ensure that wall plugs are well fitted and are a tight fit in the drilled hole.

Types Of Walls

Use one of the following types of wall plug (not included) if your walls are made of brick, breeze block, concrete, stone or wood. Screws may be able to be fixed directly to solid wood walls as they will provide a secure anchor point.

1. General purpose wall plug

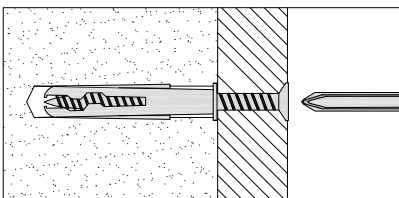

Generally aerated blocks should not be used to support heavy loads, use a specialist fitting in this case. For light loads, general purpose wall plugs can be used.

2. Plasterboard wall plug

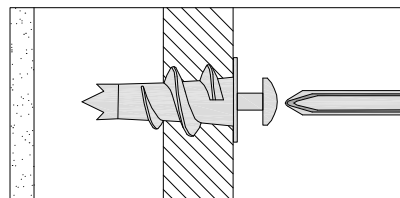

For use when attaching light loads on to plasterboard partitions or hollow wooden doors.

3. Cavity fixing wall plug

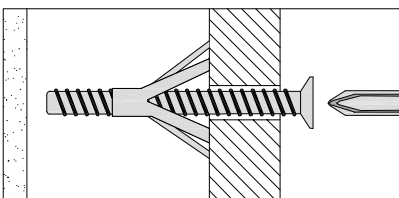

For use with plasterboard partitions or hollow wooden doors.

4. Cavity fixing-heavy duty wall plug

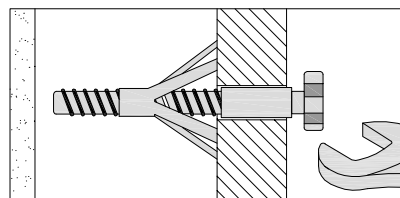

For use when fitting or supporting heavy loads such as shelving, wall cabinets and coat racks.

5. Hammer fixing wall plug

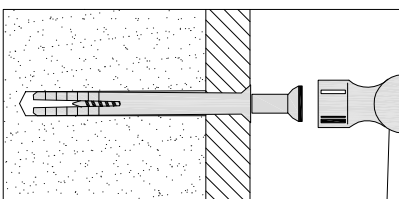

For use with walls stuck with plasterboard. The hammer fixing allows it to be fixed to the wall rather than the plasterboard. Always check the fixing is secure to the retaining wall.

6. Shield anchor wall plug - heavy loads

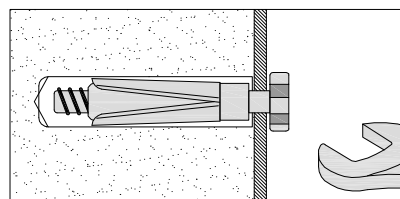

For use with heavier loads such as TV & HiFi speakers and satellite dishes etc.



MEUBILAIR
DIRECT IMPORTS

Warranty Certificate

Congratulations! You have made an excellent choice of this quality product. Our commitment to quality also includes our service. Should you, contrary to expectations, experience defects due to manufacturing faults, **Meubilair Direct Imports** will provide you with a warranty against defects as follows:

Warranty

The product is guaranteed to be free from defects in workmanship and parts for a period of 12 months from the date of purchase. Defects that occur within this warranty period, under normal use and care, will be repaired, replaced or refunded at our discretion. The benefits conferred

by this warranty are in addition to all rights and remedies in respect of the product that the consumer has under the Competition and

Consumer Act 2010 and similar state and territory laws.

Our goods come with guarantees that cannot be excluded under the Australian Consumer Law. You are entitled to a replacement or refund for a major failure and for compensation for any other reasonably foreseeable loss or damage. You are also entitled to have the goods repaired or replaced if the goods fail to be of acceptable quality and the failure does not amount to a major failure.

Proof of Purchase

This warranty is valid for the original purchase and is not transferable. Please keep your purchase docket, tax invoice or receipt as the best proof of purchase, and as proof of date on which the purchase was made.

Normal Wear and Tear

This warranty does not cover normal wear and tear to the products or parts.

Exclusions

This warranty does not cover:

- Any defects caused by an accident, misuse, abuse, improper installation or operation, lack of reasonable care, unauthorized modification, loss of parts, tampering or attempted repair by a person not authorized by the distributor.
- Any product that has not been installed, operated or maintained in accordance with the manufacturers' operating instructions provided with the product.
- Any product that has been used for purposes other than domestic use.
- Any damage caused by improper power input or improper cable connection.

MEUBILAIR DIRECT IMPORTS PTY LTD

Customer Service

Email: cs@meubilair.com.au

Address: Unit 4, 16 Hickeys Lane, Penrith, NSW, 2750

Opening Hours 9:00 am - 4:00pm (Mon-Fri)

When making a return, please ensure the product is properly packaged, so as to ensure that no damage occurs to the product during transit.

Please provide the original or a copy of the proof of purchase. Also please make sure you have included an explanation of the problem.

Please note that the costs of making a warranty claim, including any return postage, will be covered by the supplier identified above.

Please note upon receiving your warranty claim, the supplier will send, via the post or email, a repair and refurbished goods or parts notice.

Please provide your email address and advise the supplier, if you wish to obtain a repair and refurbished goods or parts notice via email.

AFTER SALES SUPPORT

EMAIL : cs@meubilair.com.au

Product code: 5295R-WHT

12/2021





MEUBILAIR
DIRECT IMPORTS

Warranty Certificate

PRODUCT NAME **HAMPTONS 1 DOOR WARDROBE.**

BRAND NAME

PRODUCT CODE **5295R-WHT**

NAME

ADDRESS

EMAIL

DAYTIME TEL NO

DATE OF PURCHASE

SERIAL NUMBER

We recommend that you attach a photocopy of your receipt, showing the date of purchase, to this Warranty certificate and **keep for your reference.**

In the event of a product fault, please email the Customer Service team. Please ensure that you include the product details (as shown on the card) at hand so that we are able to respond as quickly and efficiently as possible.

MEUBILAIR DIRECT IMPORTS PTY LTD

Customer Service

Email: cs@meubilair.com.au

Address: Unit 4, 16 Hickeys Lane , Penrith, NSW, 2750

Opening Hours 9:00 am - 4:00pm (Mon-Fri)

AFTER SALES SUPPORT

Product code: 5295R-WHT

12/2021

