

MULTI-PURPOSE CUPBOARD SINGLE DOOR WHITE



Children have been injured climbing on furniture when the child's weight has caused the furniture to topple over. A bracket and fitting instructions are included with this item to allow the cabinet to be fastened to your wall.

As the material used on walls varies from plasterboard, timber to masonry purchase a wall anchor suited to the surface that you will attach the bracket to. A wide variety of suitable fasteners is available from your local hardware store.

1.0hr

APPROXIMATE ASSEMBLY TIME

2 PERSON ASSEMBLY

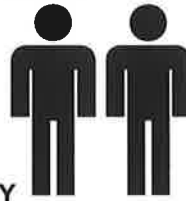

FLOOR AREA
1M x 2M



REQUIRED ASSEMBLY SPACE

REQUIRED ASSEMBLY TOOLS

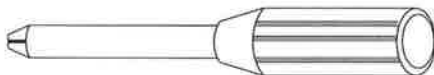

POZI SCREWDRIVER

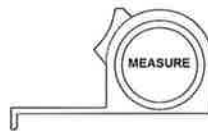

MEASURE TAPE

ASSEMBLED DIMENSIONS

24273

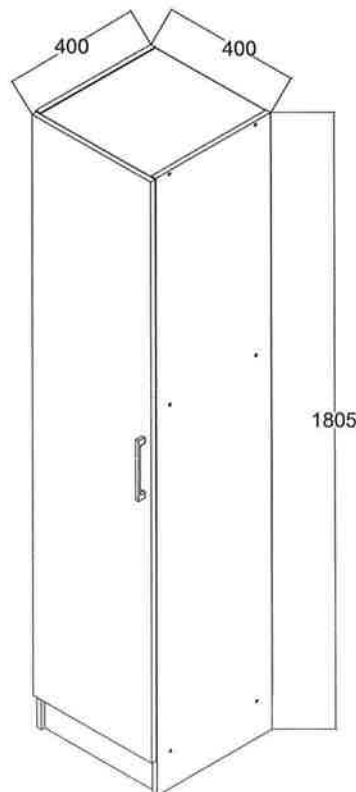

1 / 8

MULTI-PURPOSE CUPBOARD SINGLE DOOR WHITE

Tips before you start :

1. Please check that all parts are present before you start the assembly of your furniture.
2. For ease and speed of assembly, we recommend that before you commence each step of the assembly, that you identify all the parts required for that step.
3. For larger items, please ensure that you have sufficient space and people (as indicated on page 1) to assemble your product safely.
4. We recommend that, where possible, all items are assembled near to the area in which they will be placed in use, to avoid moving the product unnecessarily once assembled.
5. For the protection of your furniture, we recommend that the product is placed on a protected surface during assembly to prevent any damage.
6. During assembly please take care not to over-tighten any fittings, as this may damage the product.
7. Always place the product on a flat, steady and stable surface.
8. Do not stand on the product. Do not use the product as a stepladder.
9. This product is intended for indoor, household use only as it is non industrial product.

Care and Maintenance of your furniture

- Please periodically check all fittings and re-tighten as necessary.
- To clean your item, please use a damp cloth and wipe clean.
- Never allow any kind of liquid to remain on your furniture. Absorption can cause wood to warp or finishes to de-laminate.
- Please do not place hot items (eg. Hot drinks) directly on the surface.
- Please do not drag and pull your furniture .

MULTI-PURPOSE CUPBOARD SINGLE DOOR WHITE



12 x (A)
C/B SCREW
M3.5 X 16mm

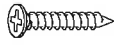

3 x (B)
C/B SCREW
M3.5 X 20mm



2 x (C)
C/B SCREW
M4 X 30mm

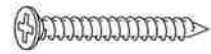

12 x (D)
C/B SCREW
M4 X 45mm



12 x (E)
SCREW COVER



16 x (F)
DOWEL Ø6 X 25mm



1 x (G)
PVC HANDLE



12 x (H)
SHELF SUPPORTS



36 x (I)
NAIL



4 x (J)
GLIDER WITH NAIL



3sets x (K)
METAL HINGE

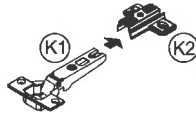

2 x (L)
L-BRACKET



2 x (M)
C/B SCREW
M3.5 X 12mm

**Requires separation before assembly

PARTS LIST

	1	1PC		2	1PC		3	3PCS
	4	3PCS		5	1PC		6	1PC
	7	1PC						

MULTI-PURPOSE CUPBOARD SINGLE DOOR WHITE

STEP 1

NOTE: THE HINGES AND HINGES PLATE ARE ALREADY ATTACHED TO EACH OTHER. PLEASE DETACH BEFORE USE.

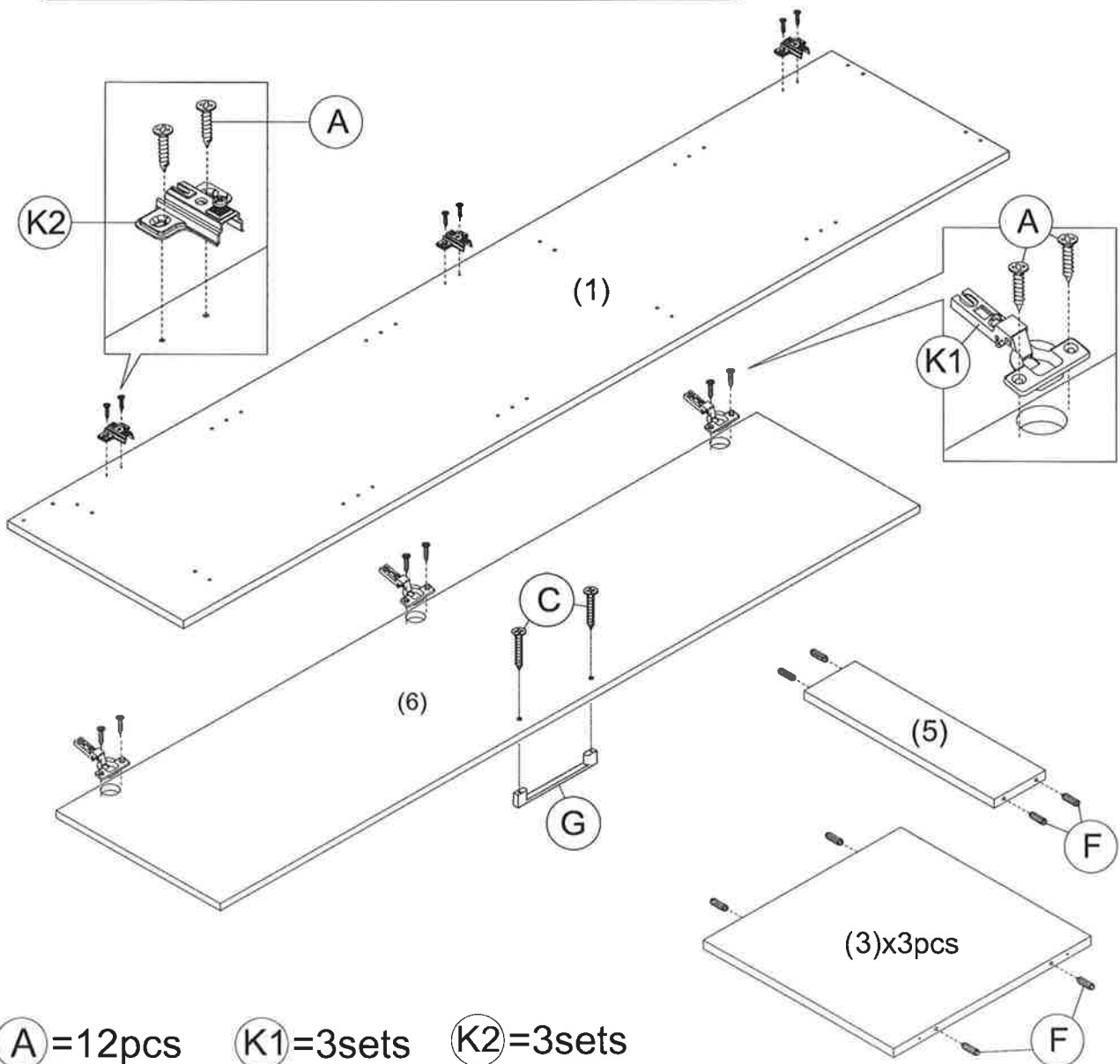
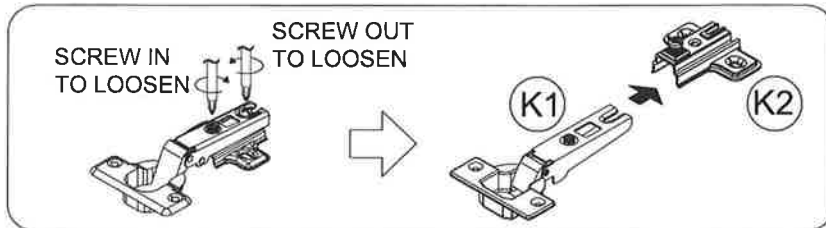

- | | | |
|-------------|--------------|--------------|
| (A) = 12pcs | (K1) = 3sets | (K2) = 3sets |
| (C) = 2pcs | (G) = 1pc | (F) = 16pcs |

MULTI-PURPOSE CUPBOARD SINGLE DOOR WHITE

STEP 2

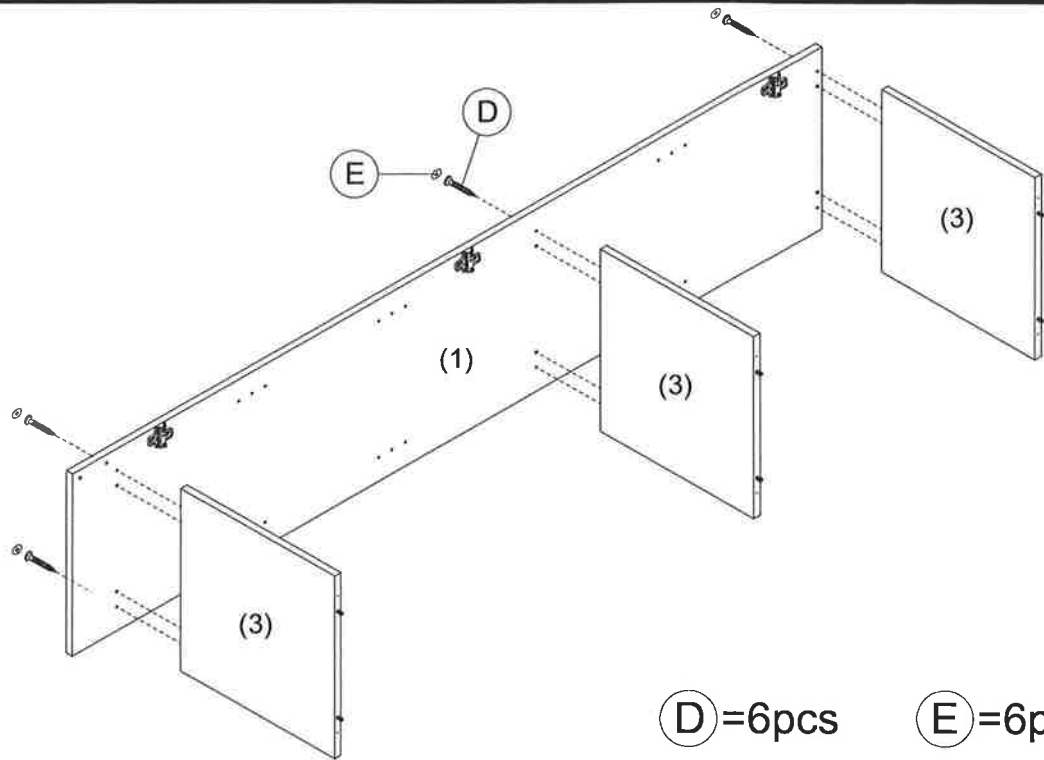

STEP 3

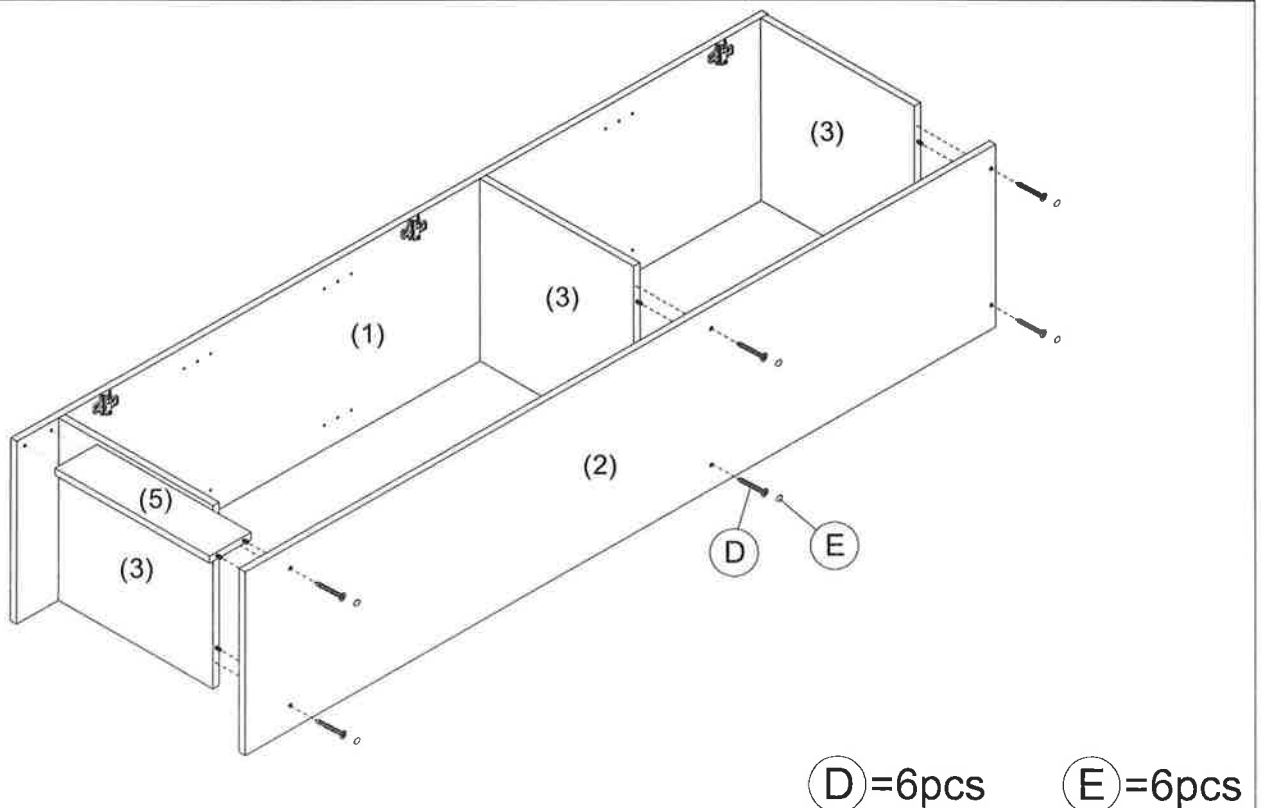

MULTI-PURPOSE CUPBOARD SINGLE DOOR WHITE

STEP 4

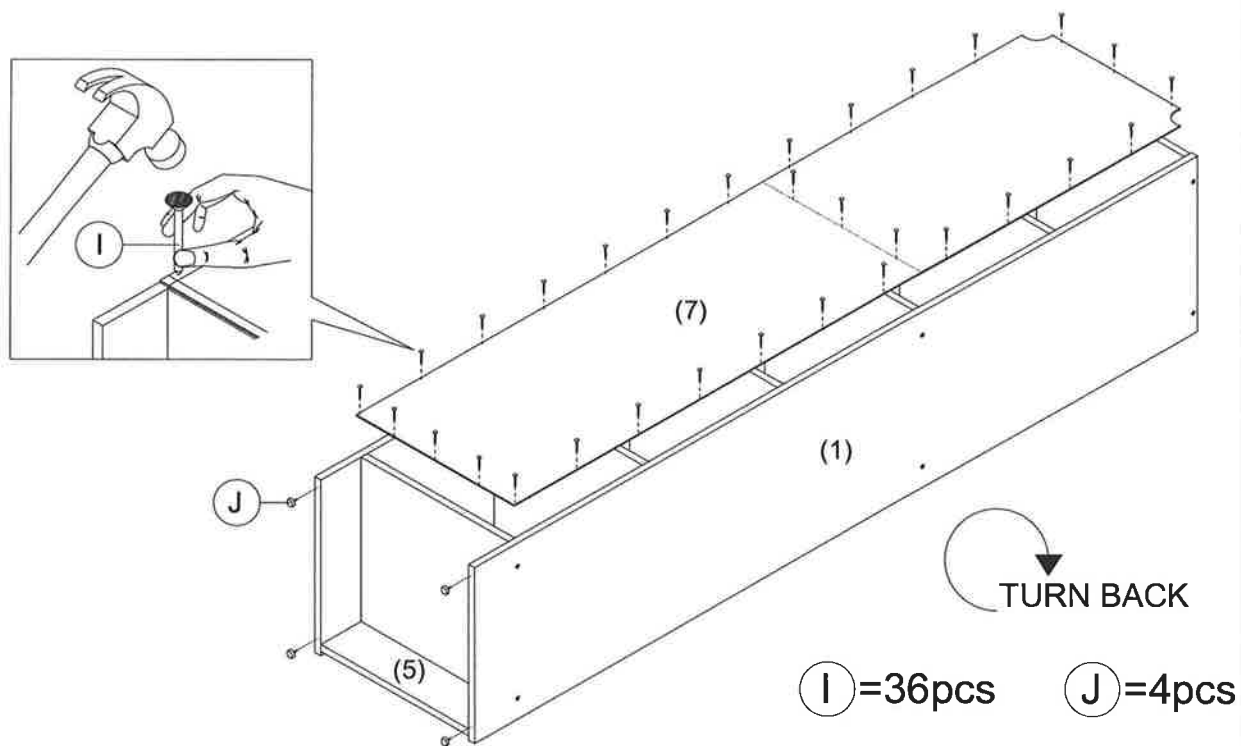

STEP 5

INSERT SHELVES

STEP 1

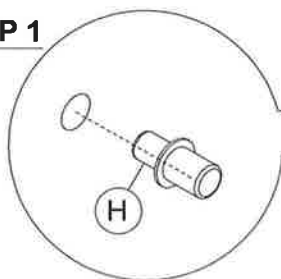

STEP 2

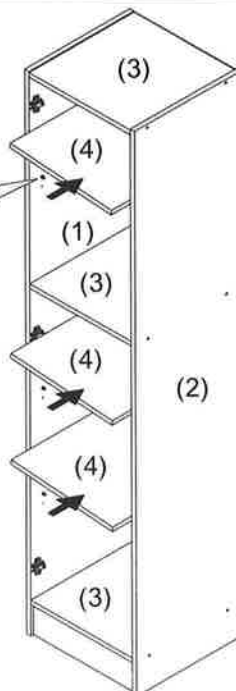
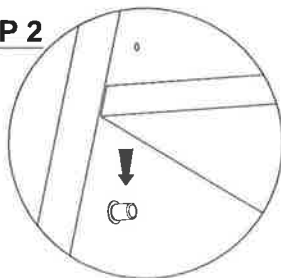

H = 12pcs

MULTI-PURPOSE CUPBOARD SINGLE DOOR WHITE

STEP 6

TO FIX THE DOOR

STEP 1

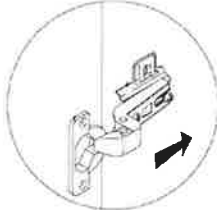

STEP 2

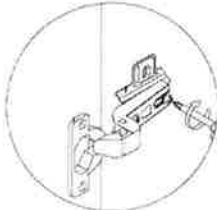

STEP 3

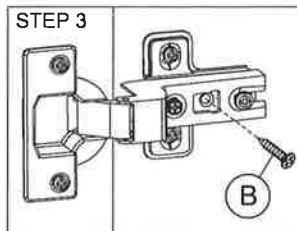

(B) = 3pcs

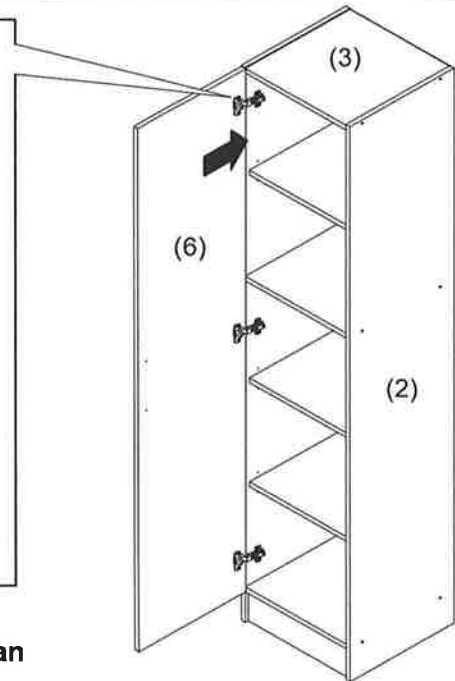

TO ADJUST THE DOOR

The step demonstrates that the alignment of the door can be adjusted after fixing the hinges.

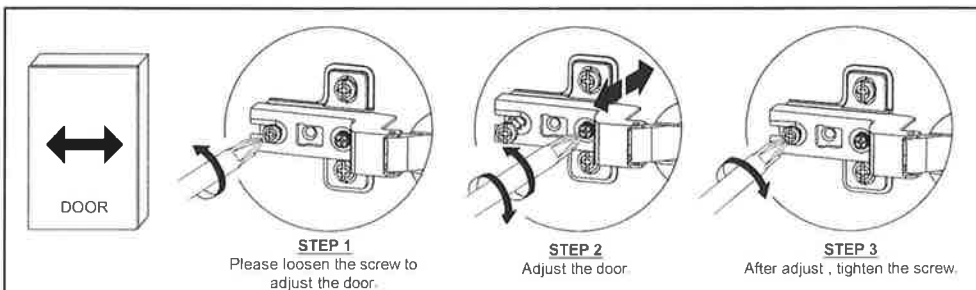
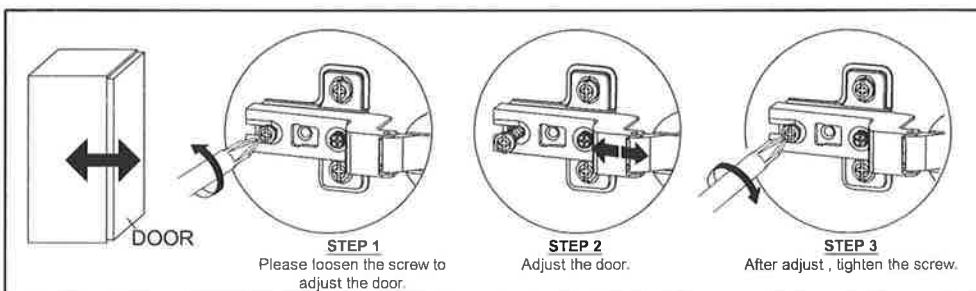
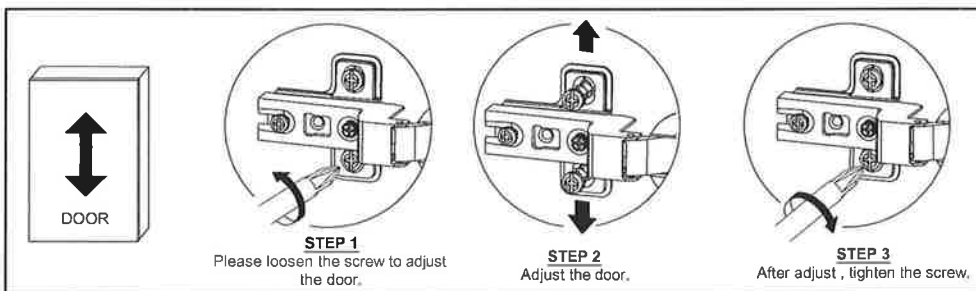

MULTI-PURPOSE CUPBOARD SINGLE DOOR WHITE

STEP 7

Bracket Fixing

The horizontal arms of the brackets are to be secured to the underside of shelf so that it is out of sight when the cabinet is installed into position.

- After assembling the unit place it against the wall where it will be permanently positioned.
- Working from inside the cabinet place the bracket through the pre-cut hole in the rear wall of the cabinet as shown in diagram.
- Use a pencil to mark through the screw hole in the bracket, where the bracket has to be attached to the wall.
- Move the cabinet away from the wall and secure the bracket to the wall at the marked position using a wall anchor suited to your wall surface.
- With the wall brackets in position, move the cabinet back to the wall allowing the horizontal arm of the bracket to enter into the cabinet through the pre-cut holes in the back wall of the cabinet.
- Then using the screw supplied, secure the horizontal arm of the brackets to the underside of the shelf.

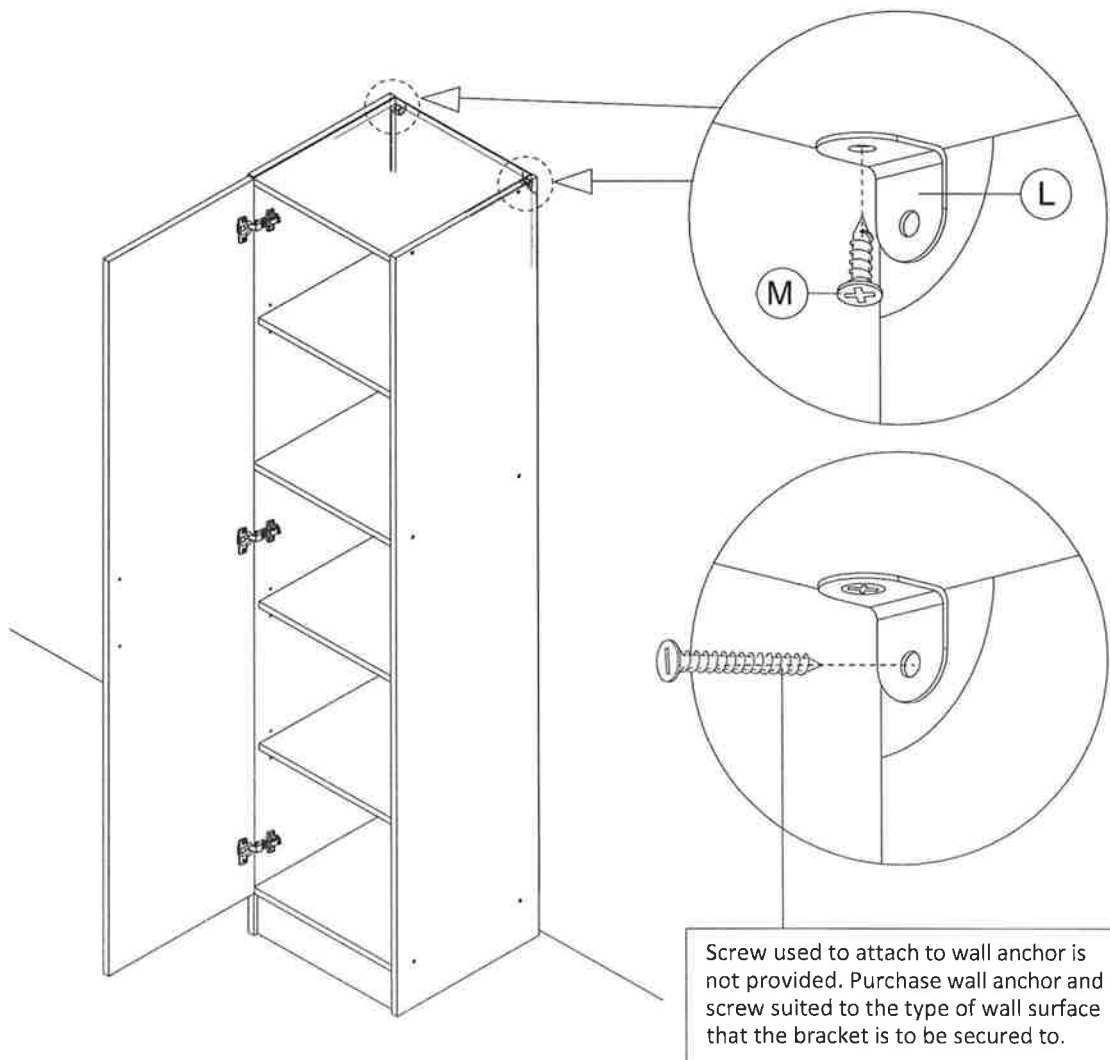

(L) = 2pcs

(M) = 2pcs