

Maine 4 Drawer Multipurpose Bathroom Cabinet

1.0hr

APPROXIMATE ASSEMBLY TIME

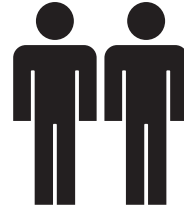

2 PERSON ASSEMBLY

FLOOR AREA
1M x 2M



REQUIRED ASSEMBLY SPACE

REQUIRED ASSEMBLY TOOLS

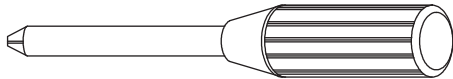

POZI SCREWDRIVER

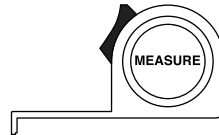

MEASURING TAPE

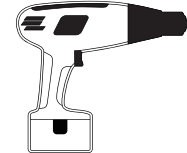

DRILL

Always use a drill with care to avoid damage to your item from over tightening

ASSEMBLED DIMENSIONS

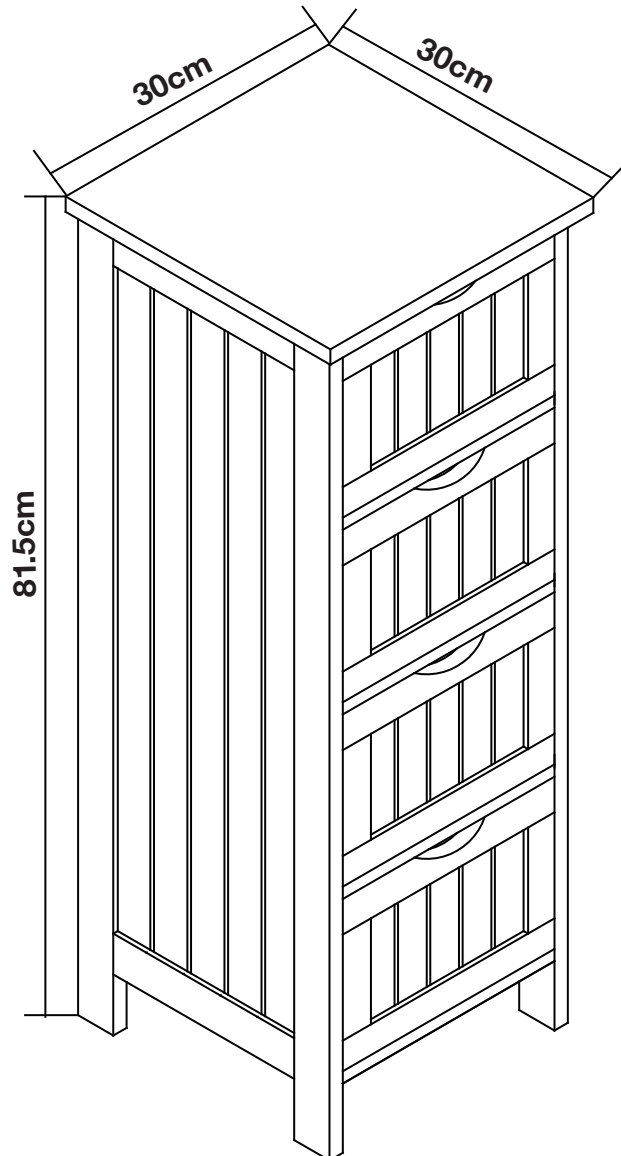

Maine 4 Drawer Multipurpose Bathroom Cabinet

Tips before you start:

1. Please check that all parts are present before you start the assembly of your furniture.
2. For ease and speed of assembly, we recommend that before you commence each step of the assembly, that you identify all the parts required for that step.
3. For larger items, please ensure that you have sufficient space and people (as indicated on page 1) to assemble your product safely.
4. We recommend that, where possible, all items are assembled near to the area in which they will be placed in use, to avoid moving the product unnecessarily once assembled.
5. For the protection of your furniture, we recommend that the product is placed on a protected surface during assembly to prevent any damage.
6. During assembly please take care not to over-tighten any fittings, as this may damage the product.
7. Always place the product on a flat, steady and stable surface.
8. Do not stand on the product. Do not use the product as a stepladder.
9. This product is intended for indoor, household use only as it is non industrial product.

Care and Maintenance of your Furniture

- Please periodically check all fittings and re-tighten as necessary.
- To clean your item, please use a damp cloth and wipe clean.
- Never allow any kind of liquid to remain on your furniture. Absorption can cause wood to warp or finishes to de-laminate.
- Please do not place hot items (eg. Hot drinks) directly on to the surface.
- Please do not drag and pull your furniture.

Maine 4 Drawer Multipurpose Bathroom Cabinet

HARDWARE LIST

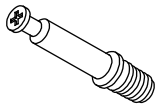

10xA
Pin



10xB
Cam Lock

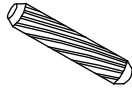

18xC
Wooden Dowel



13xD
Screw



2xE
Screw



16xF
Screw



32xG
Screw

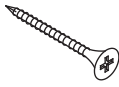

1xH
Screw



1xI



1xJ

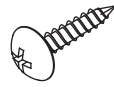

1xK

PARTS LIST

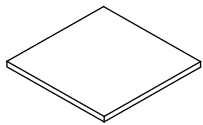

1 1PC

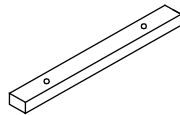

2 1PC

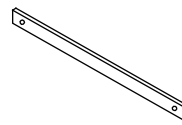

3 8PCS

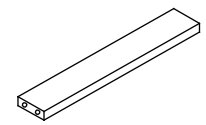

4 2PCS

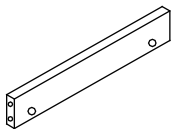

5 1PC



6 1PC

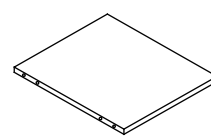

7 1PC

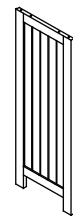

8 1PC

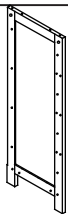

9 1PC

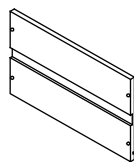

10 4PCS

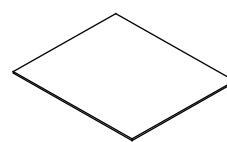

11 4PCS

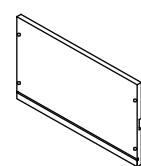

12 4PCS

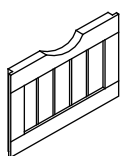

13 4PCS

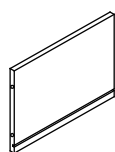

14 4PCS

Maine 4 Drawer Multipurpose Bathroom Cabinet

STEP 1

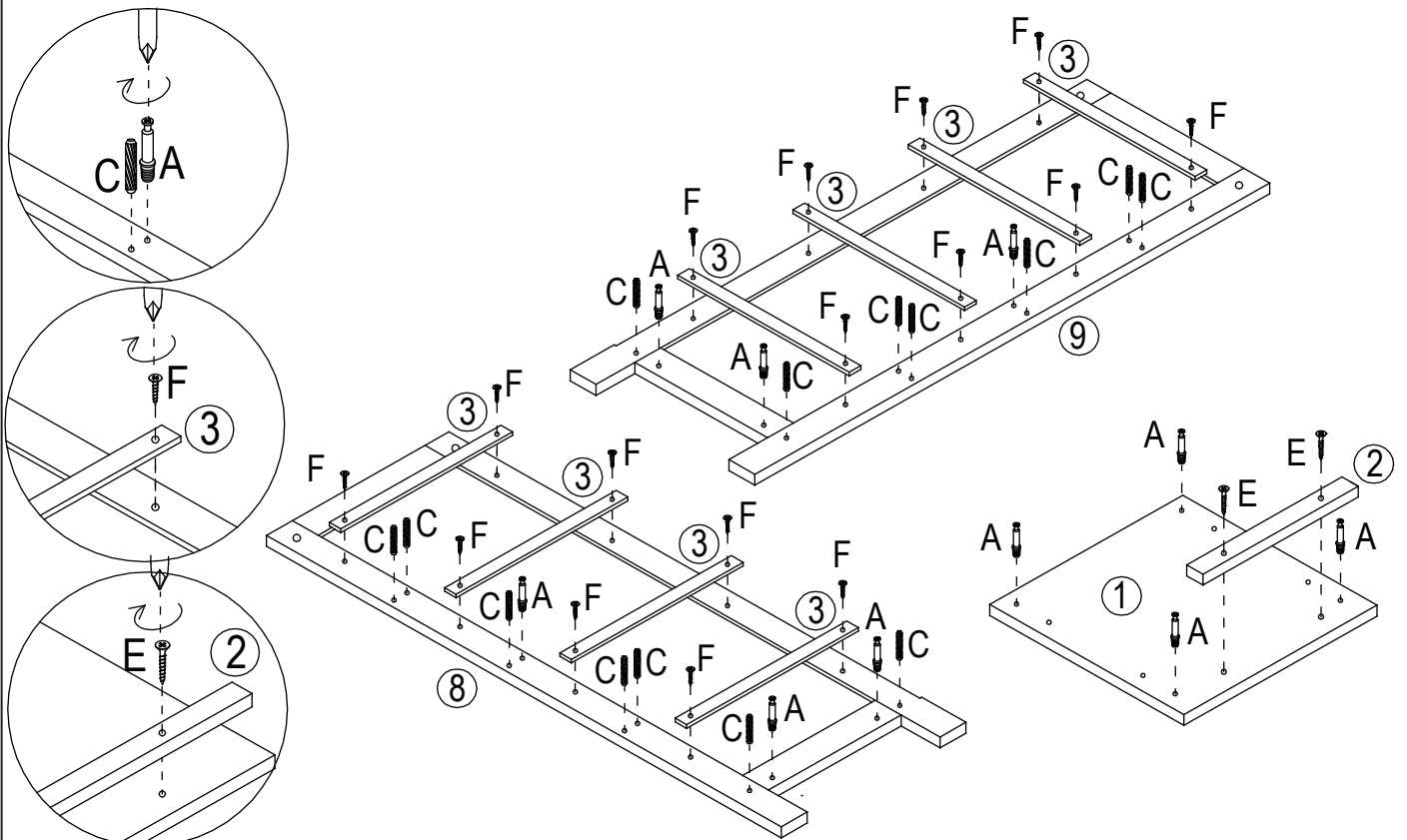

STEP 2

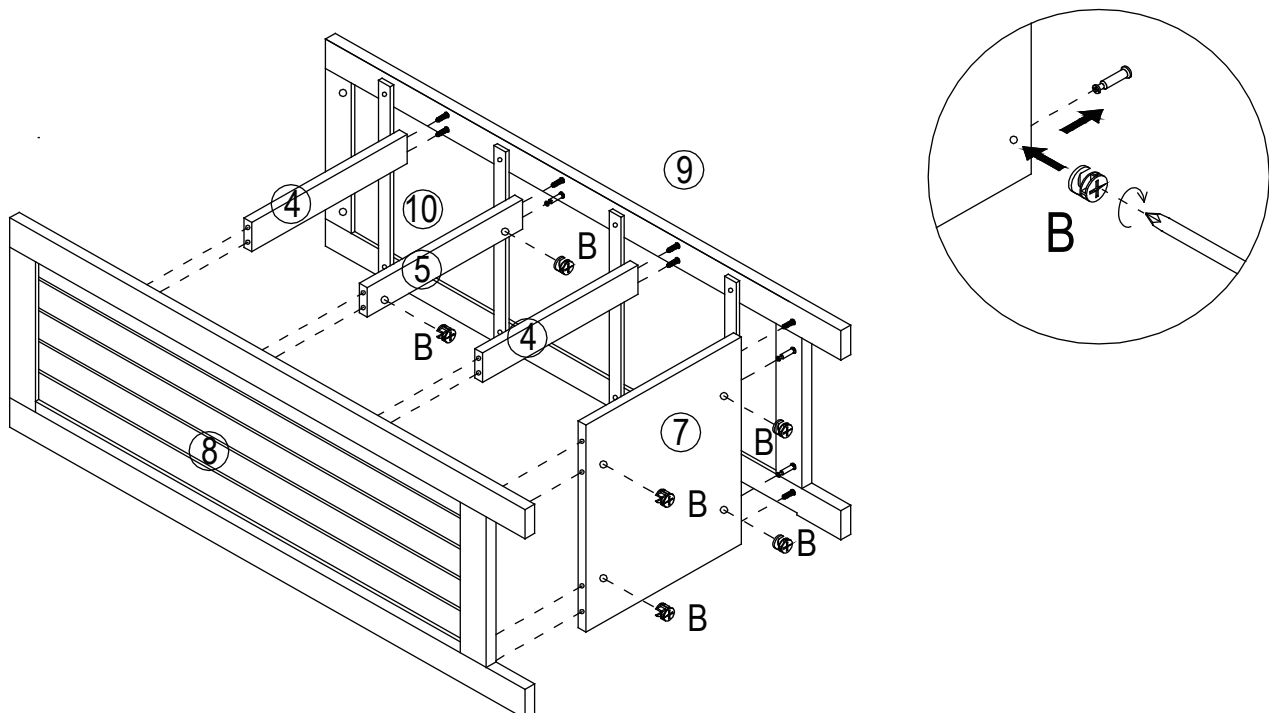

Maine 4 Drawer Multipurpose Bathroom Cabinet

STEP 3

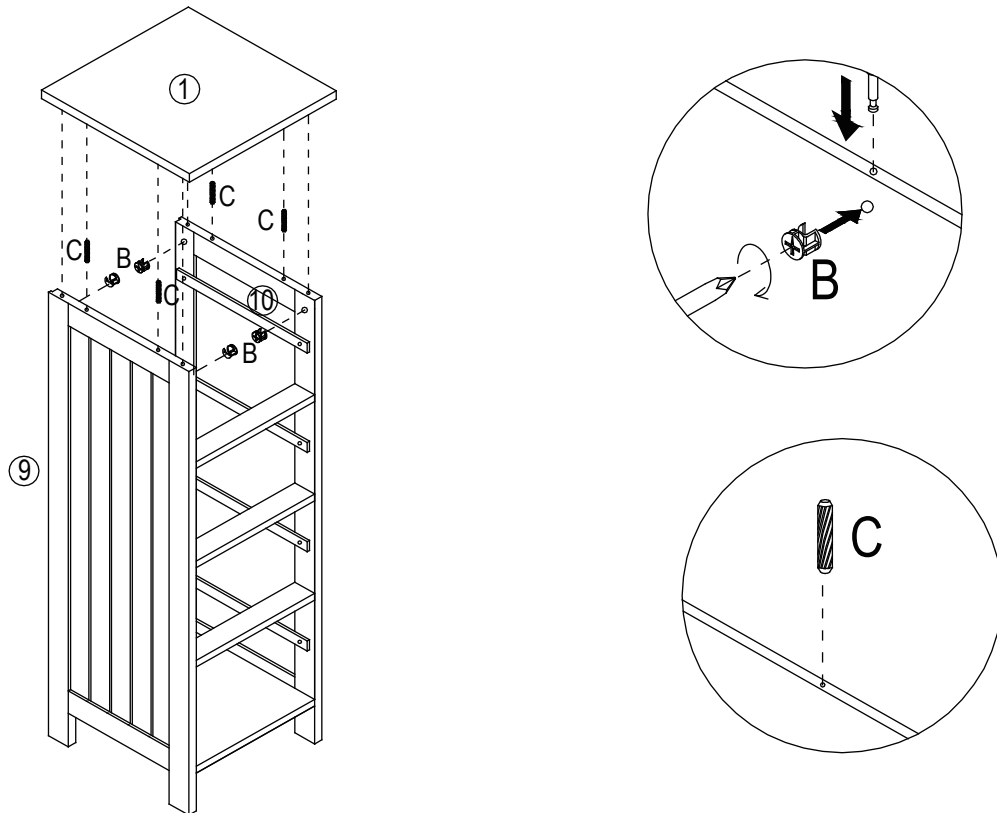

STEP 4

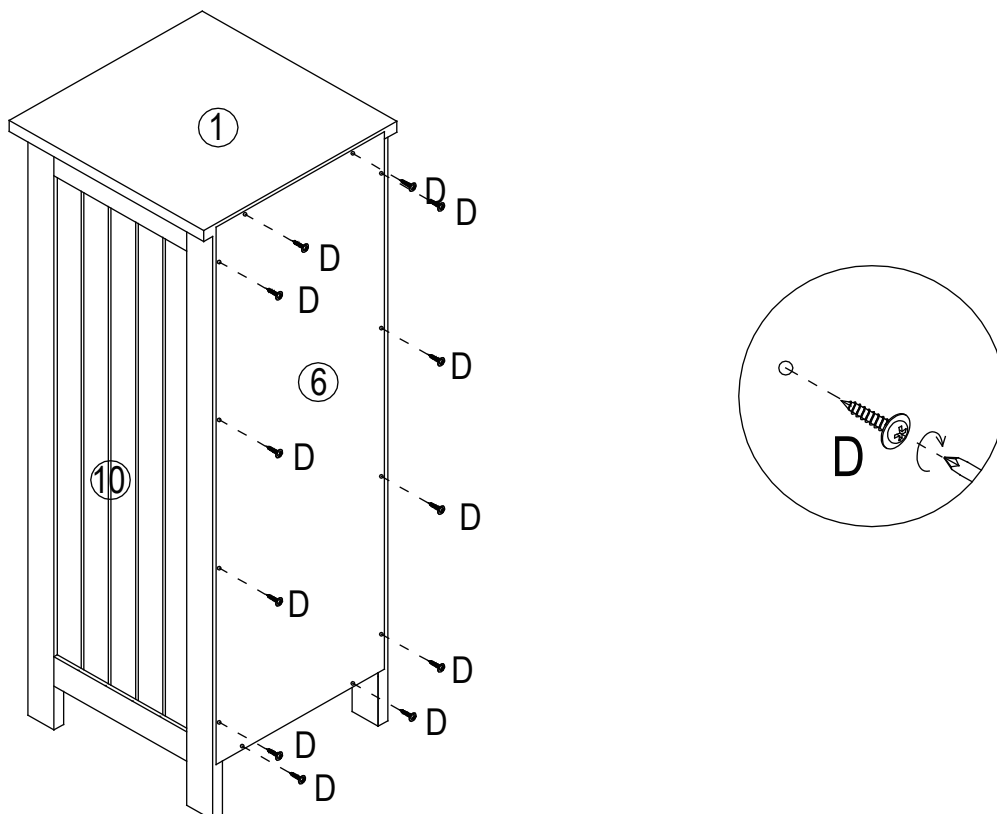

Maine 4 Drawer Multipurpose Bathroom Cabinet

STEP 5

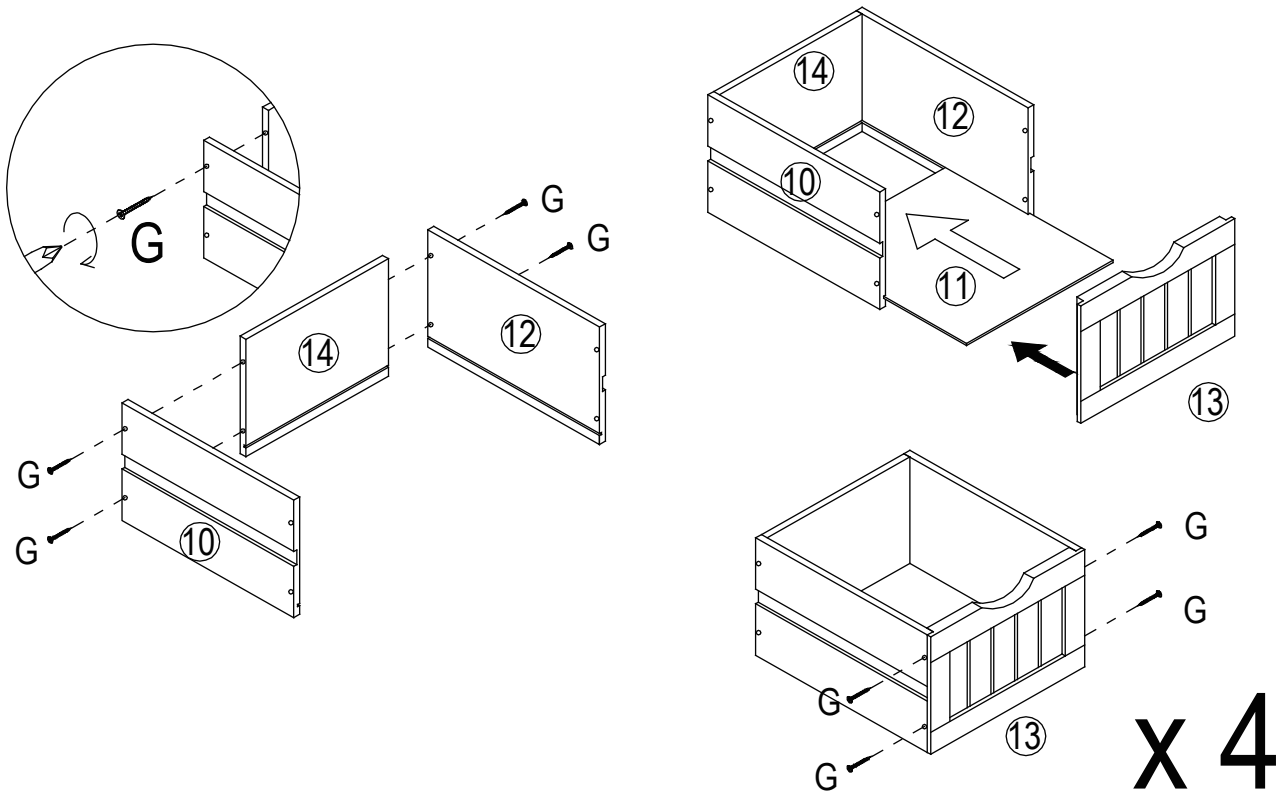

STEP 6

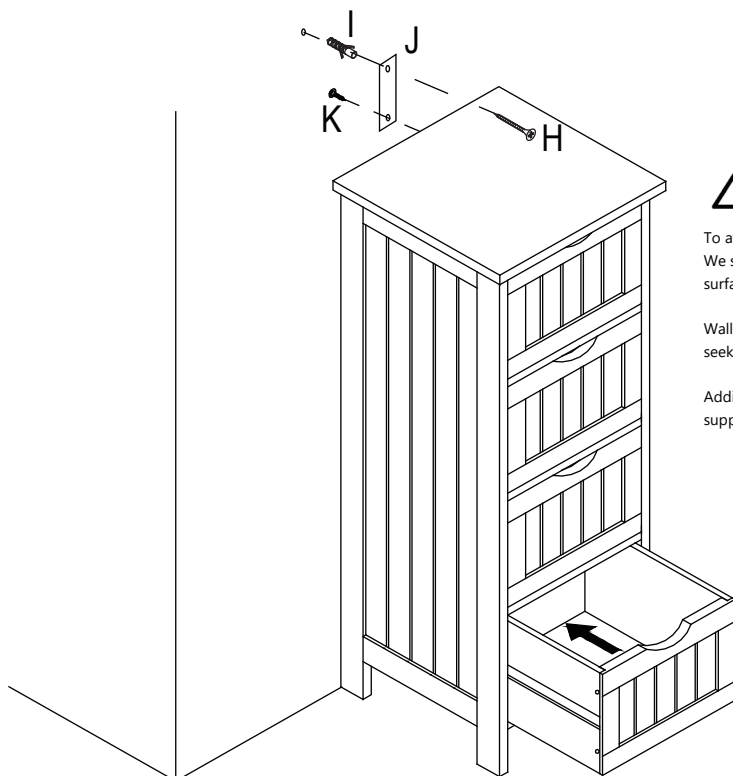

⚠ WARNING: ENSURE THAT WALL STRAP IS ATTACHED TO AVOID SERIOUS INJURY

To avoid any serious injury, this product has been supplied with a wall strap to prevent toppling. We strongly recommend that this product is permanently fixed to the wall or other suitable surface.

Wall fixing hardware has been supplied which is suitable for use only on a concrete wall. Please seek professional advice if you are in doubt of what fixing should be used.

Additional wall fixing hardware can be purchased from your local hardware store if the ones supplied are not suitable for your surface.