

BLOC DESK WITH STORAGE SHELVES

ITEM CODE: 2115-2

1.5 HR

APPROXIMATE ASSEMBLY TIME

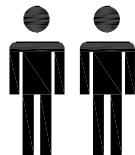

2 PERSON ASSEMBLY

FLOOR AREA
2.5M X 2.0M

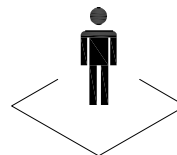

REQUIRED ASSEMBLY SPACE

REQUIRED ASSEMBLY TOOLS

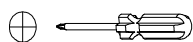

POZI SCREWDRIVER

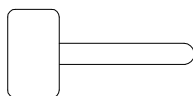

HAMMER

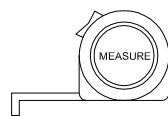

MEASURING TAPE

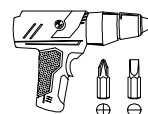

DRILL

ASSEMBLED DIMENSIONS

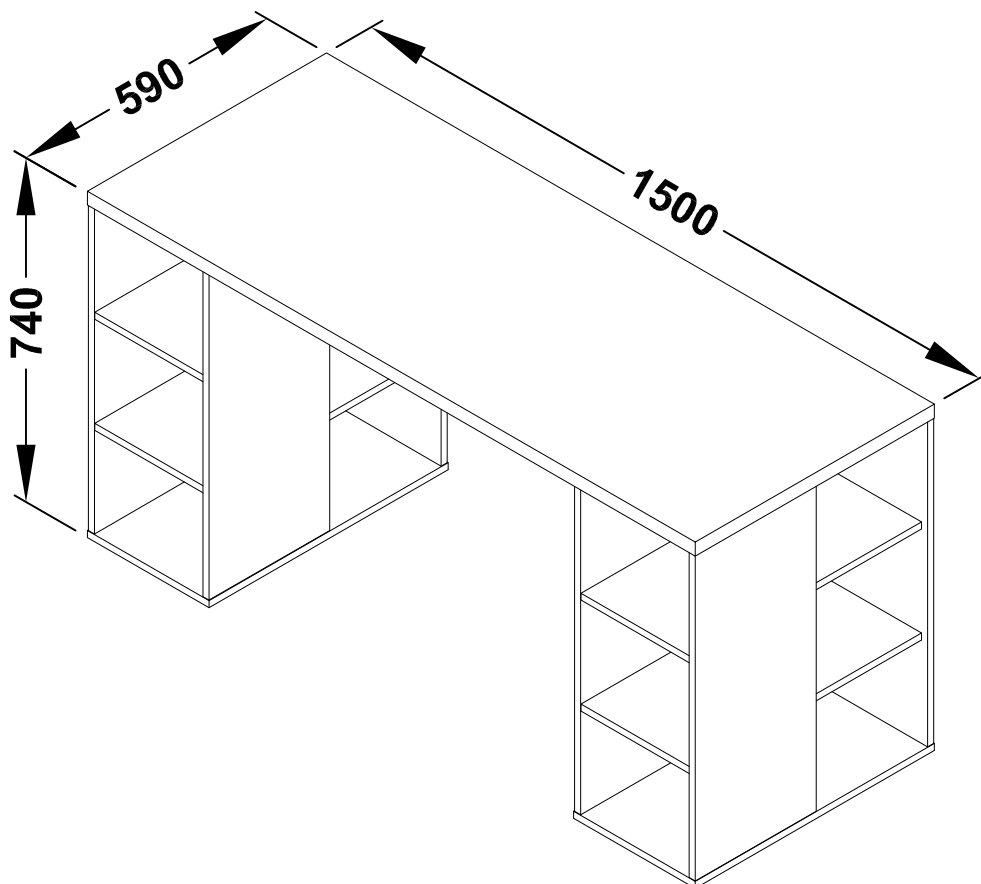

BLOC DESK WITH STORAGE SHELVES

ITEM CODE: 2115-2

Tips before you start:

1. Please check that all parts are present before you start the assembly of your furniture.
2. For ease and speed of assembly, we recommend that before you commence each step of the assembly, that you identify all the parts required for that step.
3. For larger items, please ensure that you have sufficient space and people (as indicated on page 1) to assemble your product safely.
4. We recommend that, where possible, all items are assembled near to the area in which they will be placed in use, to avoid moving the product unnecessarily once assembled.
5. For the protection of your furniture, we recommend that the product is placed on a protected surface during assembly to prevent any damage.
6. During assembly please take care not to over-tighten any fittings, as this may damage the product.
7. Always place the product on a flat, steady and stable surface.
8. Do not stand on the product. Do not use the product as a stepladder.
9. This product is intended for indoor, household use only as it is non industrial product.

Care and Maintenance of your Furniture

- Please periodically check all fittings and re-tighten as necessary.
- To clean your item, please use a damp cloth and wipe clean.
- Never allow any kind of liquid to remain on your furniture. Absorption can cause wood to warp or finishes to de-laminate.
- Please do not place hot item (e.g. hot drinks) directly on to the wood surface.
- Please do not drag or pull your furniture.

BLOC DESK WITH STORAGE SHELVES

ITEM CODE: 2115-2

Tips before you start:

QUICKFIT

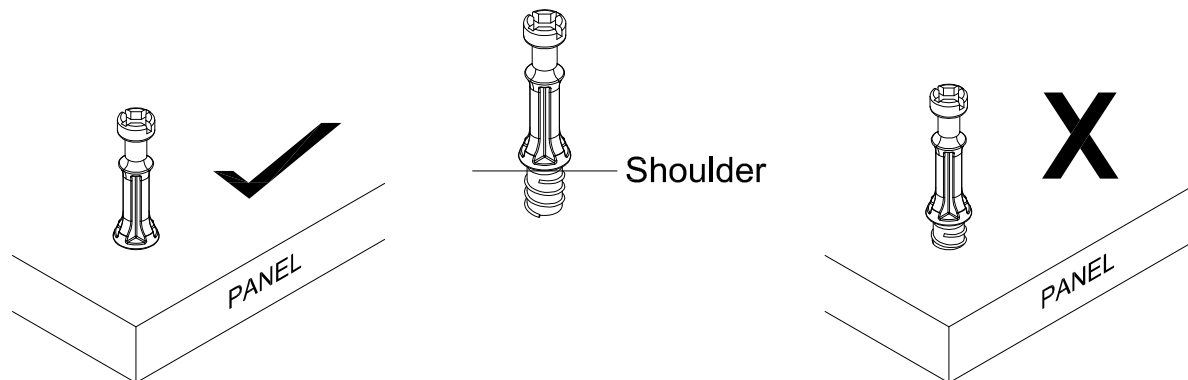

Tighten quickfit until shoulder is flush with panel. Do not overtighten or undertighten.

CAM LOCK

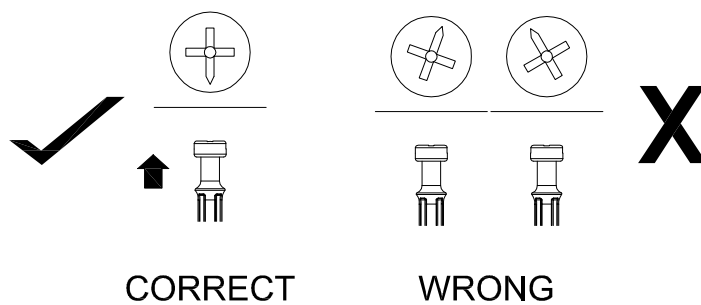

When fitting cam lock, ensure starting position is correct before you insert connecting quickfit.

Quickfit head should be in the centre of the cam lock when the two panels are joined.

Cam lock should be inserted before quickfit.

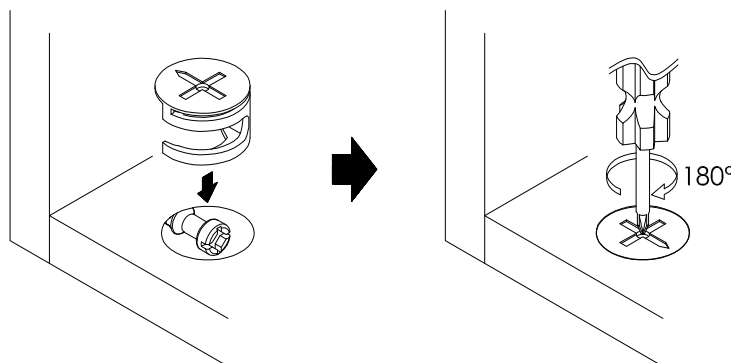

Turn camlock clockwise to tighten.

BLOC DESK WITH STORAGE SHELVES

ITEM CODE: 2115-2

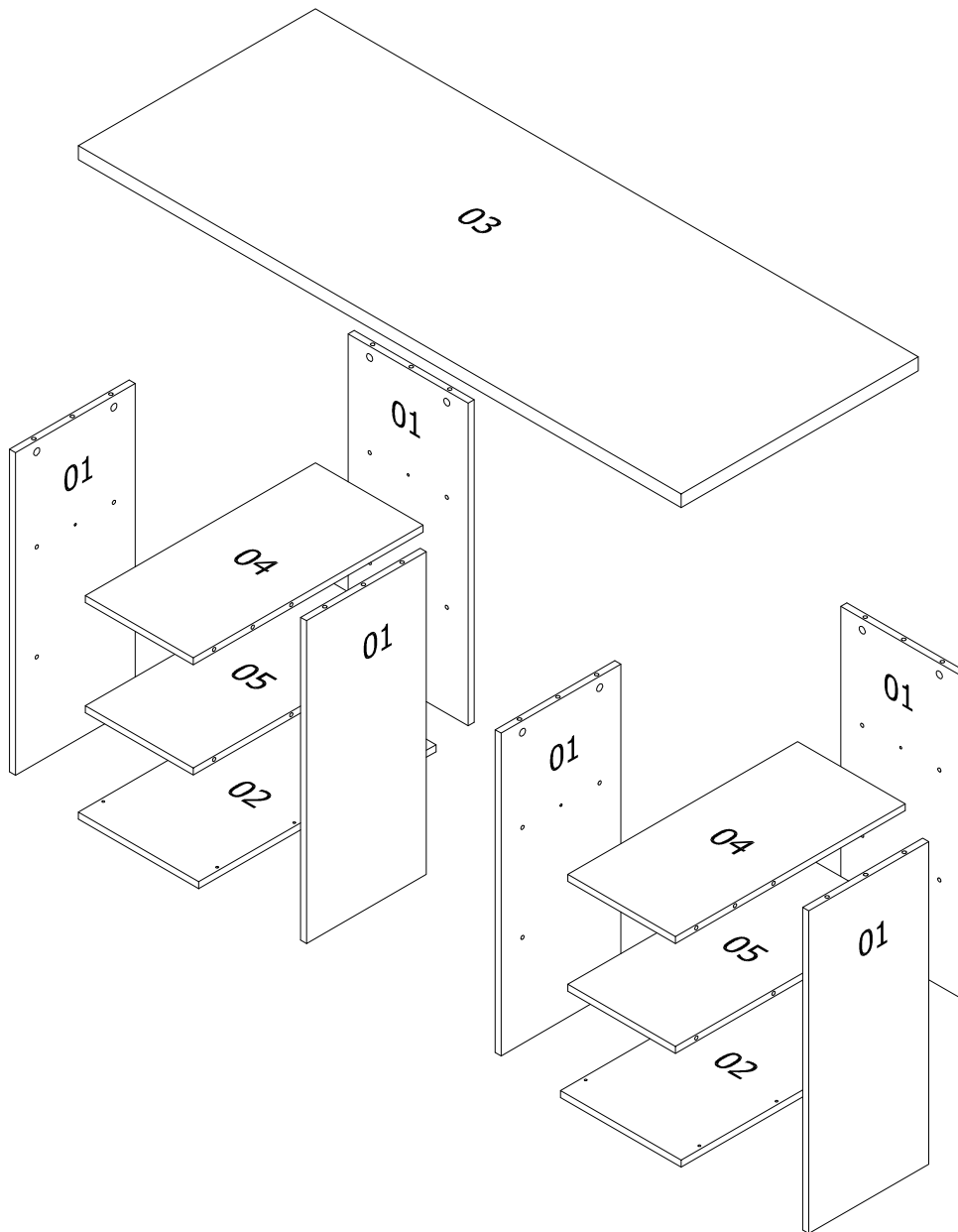

PART LIST:

NO.	PART NAME	QTY
1	SIDE / BACK PANEL (LEFT / RIGHT)	6
2	BOTTOM PANEL	2

NO.	PART NAME	QTY
3	TOP PANEL	1
4	SHELF PANEL (TOP)	2
5	SHELF PANEL (BOTTOM)	2

BLOC DESK WITH STORAGE SHELVES

ITEM CODE: 2115-2

HARDWARE LIST

(A) X12



SCREW
M4.7 X 38MM

(B) X30

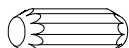

WOOD DOWEL
Ø8 X 25MM

(C) X18

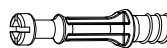

BOLT-9607 PARALEL
NECK DOWEL 24 X 8.5

(D) X18



CAM-9642 CAM
3000 12/13MM

(E) X18



ROUND STICKER
(Ø18MM)

(F) X1

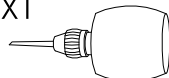

GLUE

BLOC DESK WITH STORAGE SHELVES

ITEM CODE: 2115-2

STEP 1

Using glue (F) insert dowel (B) into pieces (1, 4 & 5) as shown.

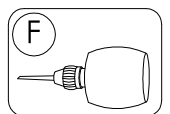
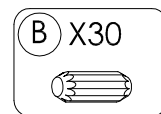
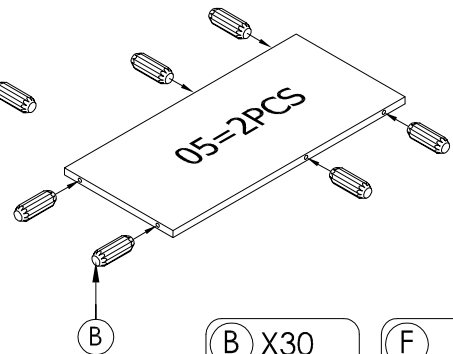
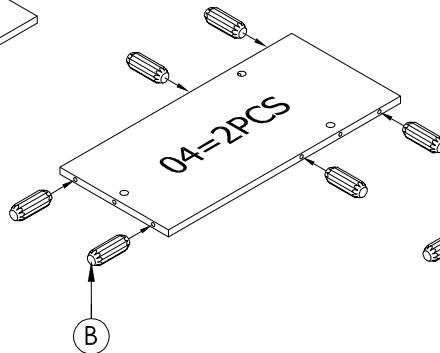
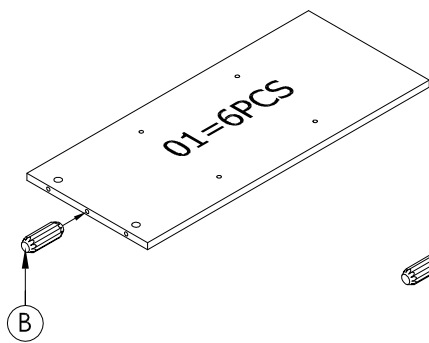
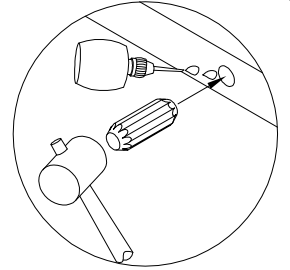

STEP 2

Take both side panels (1 & 3), using a drill on low speed / torque or a phillips head screw driver CAM PINS (C) as shown.

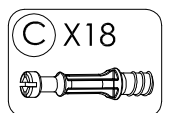
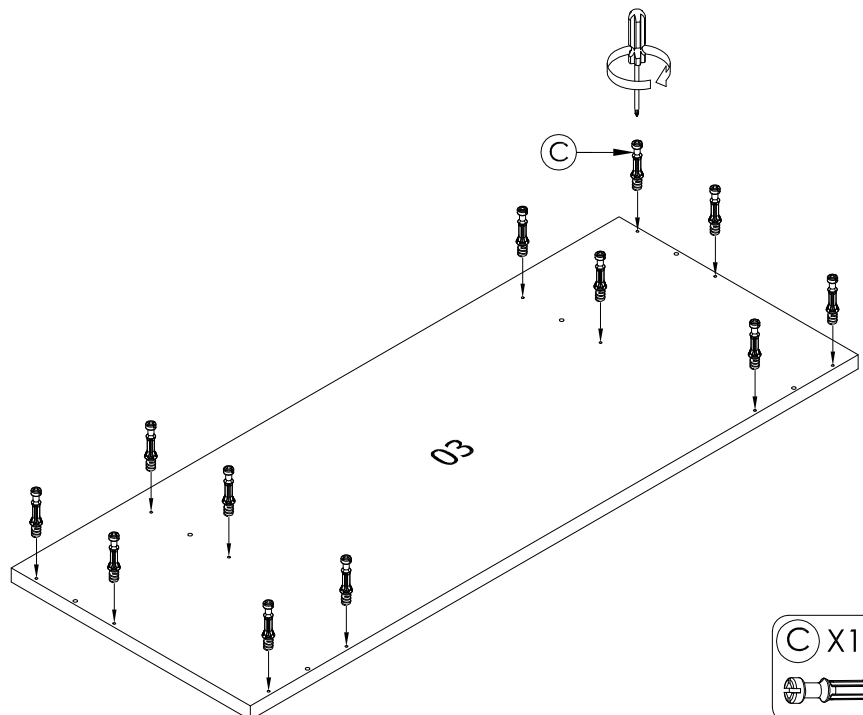
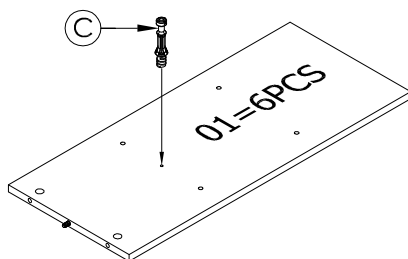

BLOC DESK WITH STORAGE SHELVES

ITEM CODE: 2115-2

STEP 3

Lay panel (1) flat (on a clean dry surface) . Using glue (F) attach with CAM LOCKS (D) panels (4). Attach 18mm round sticker(E) to top of the cam locks as shown. Attach panels (5) using glue. (NOTE: holes for feet attachment should face bottom of cabinet).

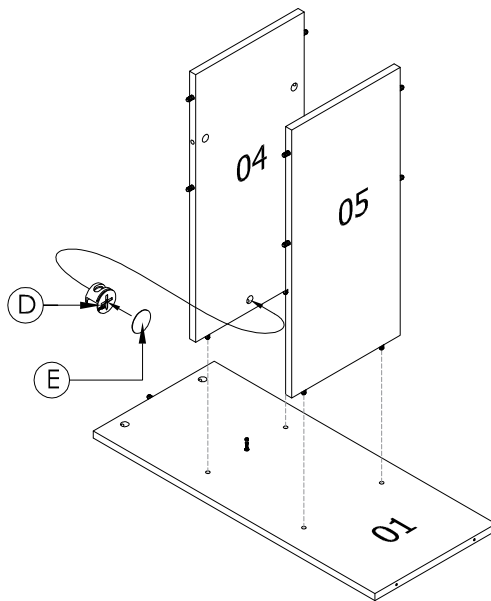
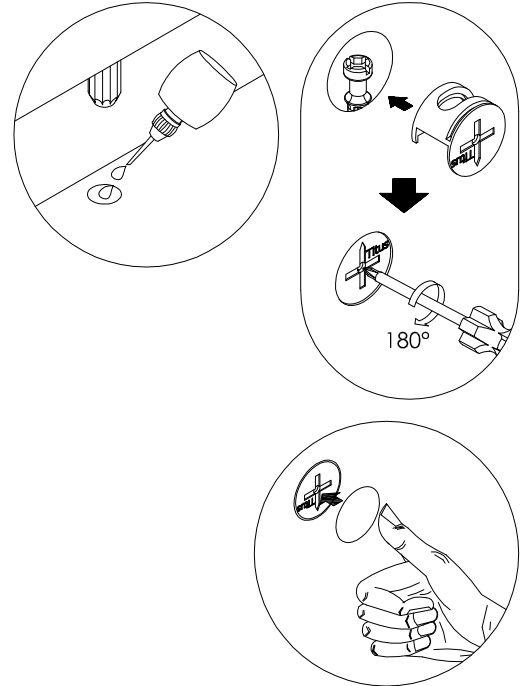

X2

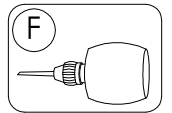
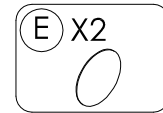
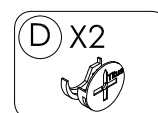

BLOC DESK WITH STORAGE SHELVES

ITEM CODE: 2115-2

STEP 4

Lay panel (1) flat (on a clean dry surface) . Using glue (F) attach with CAM LOCKS (D) panels (4). Attach 18mm round sticker(E) to top of the cam locks as shown. Attach panels (5) using glue. (NOTE: holes for feet attachment should face bottom of cabinet).

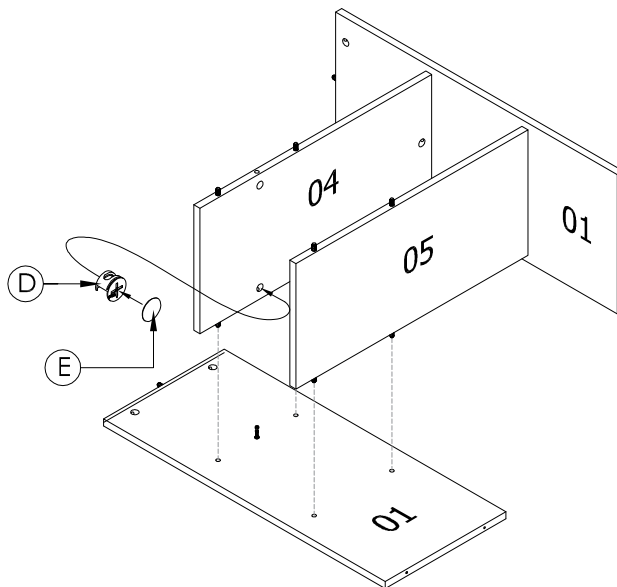
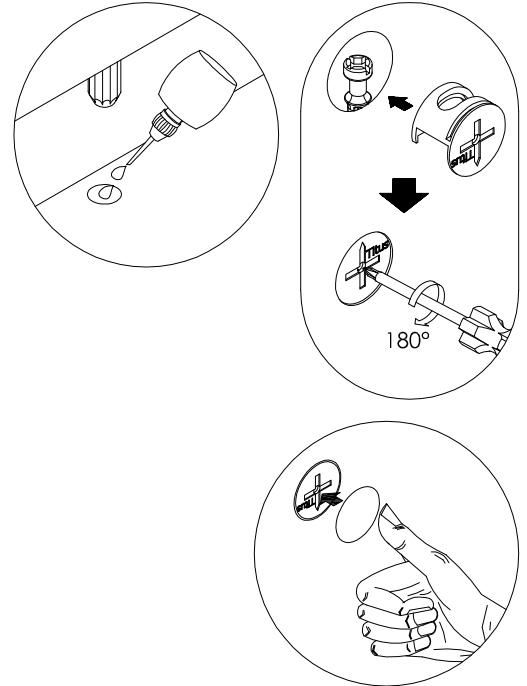

X2

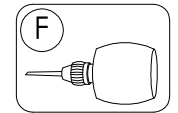
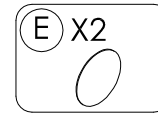
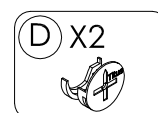

BLOC DESK WITH STORAGE SHELVES

ITEM CODE: 2115-2

STEP 5

Lay panel (1) flat (on a clean dry surface) . Using glue (F) attach with CAM LOCKS (D) panels (4). Attach 18mm round sticker(E) to top of the cam locks as shown. Attach panels (5) using glue. (NOTE: holes for feet attachment should face bottom of cabinet).

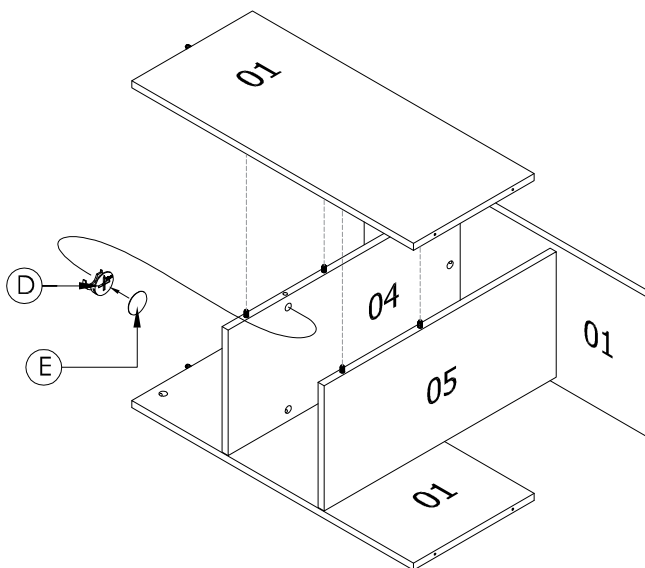
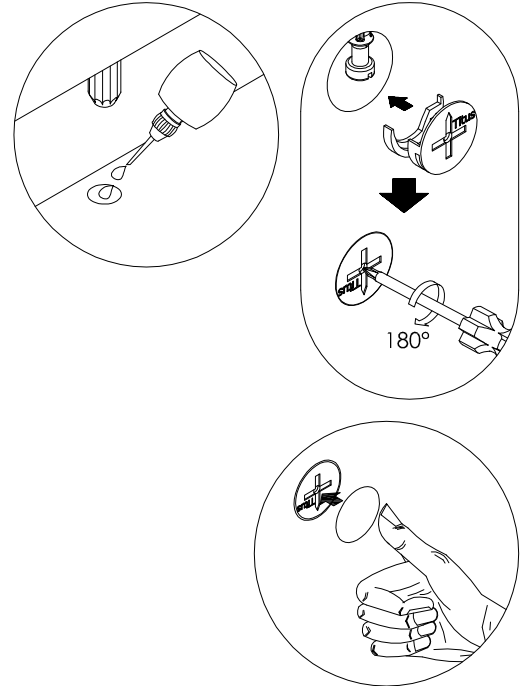

X2

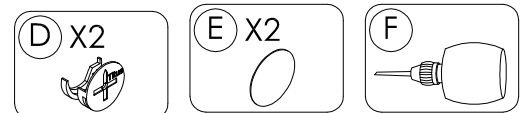

BLOC DESK WITH STORAGE SHELVES

ITEM CODE: 2115-2

STEP 6

Attach panel (2) to frame using screw 38mm (A) as shown.

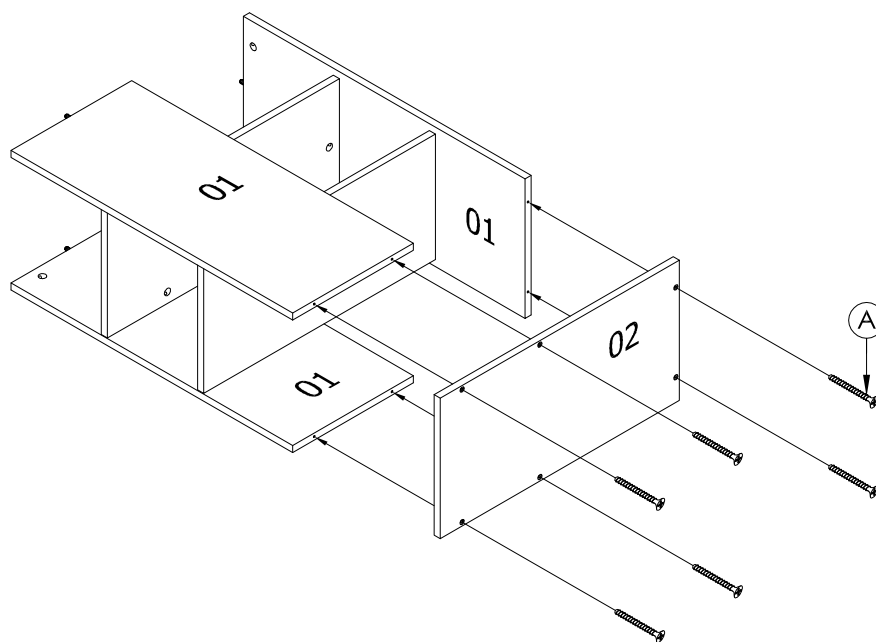

X2

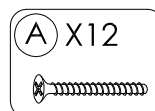

BLOC DESK WITH STORAGE SHELVES

ITEM CODE: 2115-2

STEP 7

Attach top panels (3) to frame using glue (F) and CAM LOCKS (D). Attach 18mm round sticker (E) to top of the cam locks as shown.

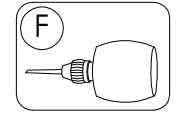
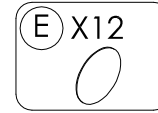
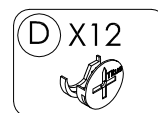
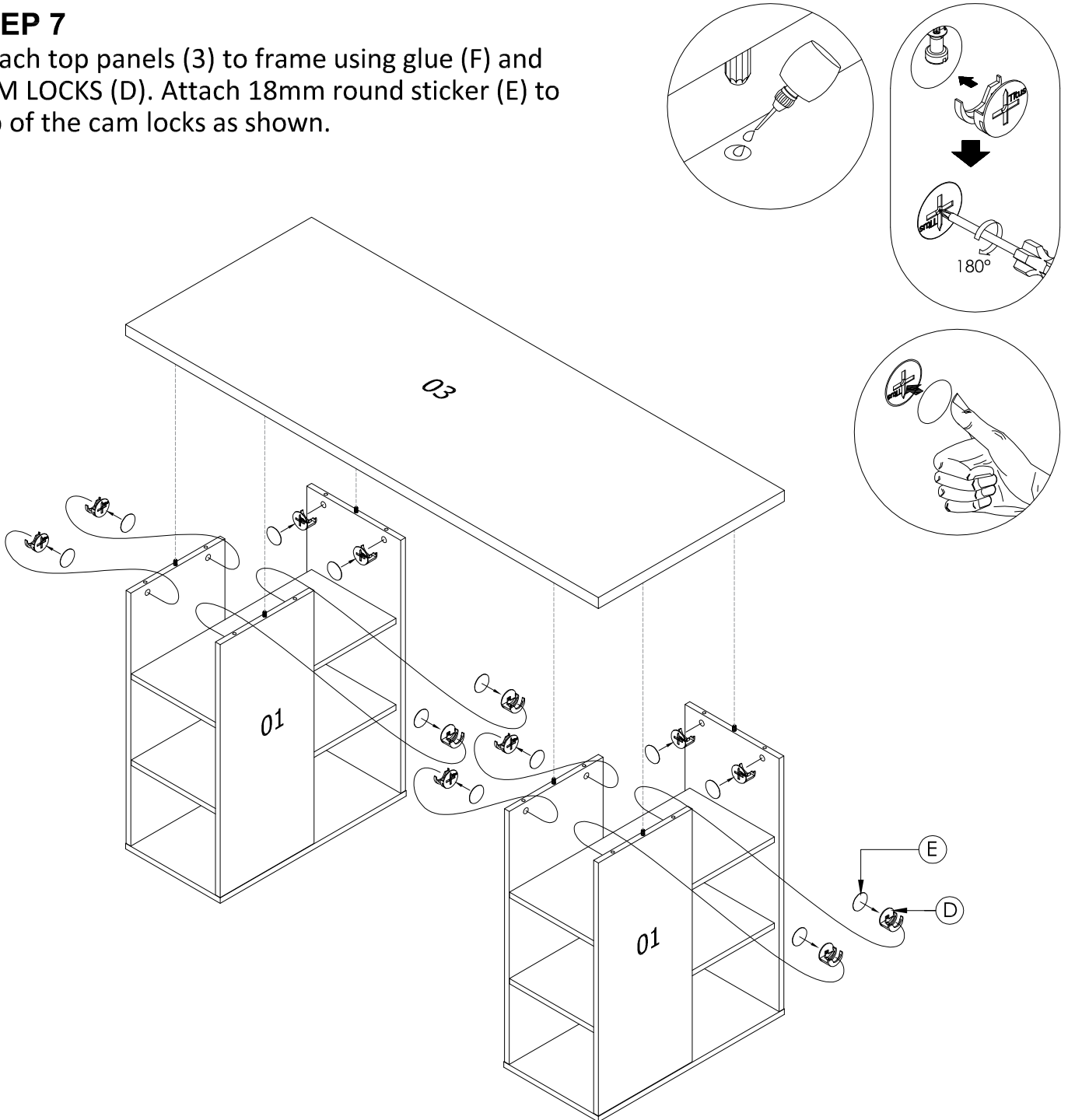



MEUBILAIR
DIRECT IMPORTS

Warranty Certificate

Congratulations! You have made an excellent choice of this quality product. Our commitment to quality also includes our service. Should you, contrary to expectations, experience defects due to manufacturing faults, **Meubilair Direct Imports** will provide you with a warranty against defects as follows:

Warranty

The product is guaranteed to be free from defects in workmanship and parts for a period of 12 months from the date of purchase. Defects that occur within this warranty period, under normal use and care, will be repaired, replaced or refunded at our discretion. The benefits conferred

by this warranty are in addition to all rights and remedies in respect of the product that the consumer has under the Competition and

Consumer Act 2010 and similar state and territory laws.

Our goods come with guarantees that cannot be excluded under the Australian Consumer Law. You are entitled to a replacement or refund for a major failure and for compensation for any other reasonably foreseeable loss or damage. You are also entitled to have the goods repaired or replaced if the goods fail to be of acceptable quality and the failure does not amount to a major failure.

Proof of Purchase

This warranty is valid for the original purchase and is not transferable. Please keep your purchase docket, tax invoice or receipt as the best proof of purchase, and as proof of date on which the purchase was made.

Normal Wear and Tear

This warranty does not cover normal wear and tear to the products or parts.

Exclusions

This warranty does not cover:

- Any defects caused by an accident, misuse, abuse, improper installation or operation, lack of reasonable care, unauthorized modification, loss of parts, tampering or attempted repair by a person not authorized by the distributor.
- Any product that has not been installed, operated or maintained in accordance with the manufacturers' operating instructions provided with the product.
- Any product that has been used for purposes other than domestic use.
- Any damage caused by improper power input or improper cable connection.

MEUBILAIR DIRECT IMPORTS PTY LTD

Customer Service

Email: cs@meubilair.com.au

Address: Unit 4, 4-5 Lambridge Place, Penrith, NSW, 2750

Opening Hours 9:00 am - 4:30pm (Mon-Fri)

When making a return, please ensure the product is properly packaged, so as to ensure that no damage occurs to the product during transit.

Please provide the original or a copy of the proof of purchase. Also please make sure you have included an explanation of the problem.

Please note that the costs of making a warranty claim, including any return postage, will be covered by the supplier identified above.

Please note upon receiving your warranty claim, the supplier will send, via the post or email, a repair and refurbished goods or parts notice.

Please provide your email address and advise the supplier, if you wish to obtain a repair and refurbished goods or parts notice via email.

AFTER SALES SUPPORT

EMAIL : cs@meubilair.com.au

Product code: 2115-2

03/2017





MEUBILAIR
DIRECT IMPORTS

Warranty Certificate

PRODUCT NAME **BLOC DESK WITH STORAGE SHELVES**

BRAND NAME

PRODUCT CODE **2115-2**

NAME

ADDRESS

EMAIL

DAYTIME TEL NO

DATE OF PURCHASE

SERIAL NUMBER

We recommend that you attach a photocopy of your receipt, showing the date of purchase, to this Warranty certificate and **keep for your reference**.

In the event of a product fault, please email the Customer Service team. Please ensure that you include the product details (as shown on the card) at hand so that we are able to respond as quickly and efficiently as possible.

MEUBILAIR DIRECT IMPORTS PTY LTD

Customer Service

Email: cs@meubilair.com.au

Address: Unit 4, 4-5 Lambridge Place, Penrith, NSW, 2750

Opening Hours 9:00 am - 4:30pm (Mon-Fri)

AFTER SALES SUPPORT

Product code: 2115-2

03/2017

