

TY-S0408 File Cabinet

ASSEMBLY INSTRUCTION

Thanks for purchasing one of our products, please read carefully the assembly instructions before the installation (Attention: Do not tighten the screws before all screws are in place).

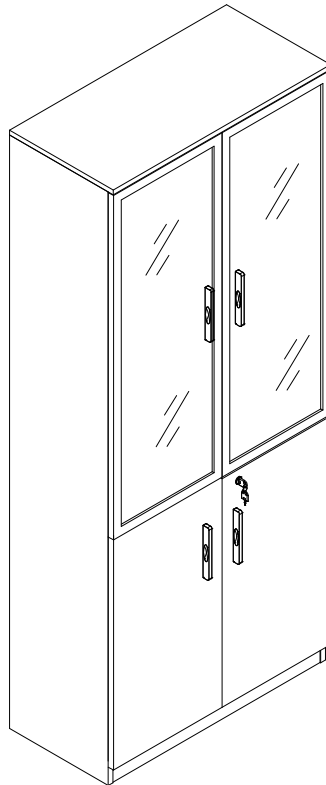

60 MINS



2 PERSONS
ASSEMBLY

TY-S0408

General Care:

-Keep your furniture out direct sunlight-Use desk pads and coasters to protect the surface from dents,scratches,and moisture from hot or cold liquids.

Cleaning:

-For cleaning, wipe the surface with a damp (not wet) cloth or a dry clean lint free cotton cloth.

IMPORTANT - Please Read These Instructions Carefully Before Assembly.

Keep children and animals away from the work area, small parts could cause choking if swallowed. Assemble the item as close to its intended position (in the same room) as possible.

Assemble on a soft level surface to avoid damage.

Remove all fittings from the plastic bags and separate them into their groups.

Check you have all the components and tools listed. Make sure you have enough space to layout the parts before assembly.

Do not stand or put weight on the product, which could cause damage.

Additional Tool required is screw-driver.



Dispose of all packaging carefully and responsibly.

Parts of the assembly will be easier with 2 people.

Every few months, check that there are no loose fittings on this unit.

This product should not be discarded with household waste. Take to your local authority waste disposal center.

How to use safely

Spilt liquids should be blotted rather than wiped off. This should be done immediately using a soft cloth after a spillage has occurred, then wipe it clean and dry it as stated above. It's important to carry out this procedure to prevent liquids penetrating the surface as this could cause a separation and/or splitting of the surface material.

Furniture tops may be damaged by hot plates, wet cups and objects with sharp or hard surfaces. It is recommended to use place mats.

Furniture should only be used in accordance with its structure and intended purpose of use. For your safety, the furniture should not be used as the replacement of a ladder, steps or hanger, etc. If some parts are missing or damaged, stop using the furniture until they are replaced with the original replacements.

Doors, drawers, and shelves should not be unnecessarily left open (pulled out) as it can endanger the safety of users, especially children.

The Furniture should be placed at least 1 meter from active heat sources such as radiators and heaters. They should be used in rooms that are dry, closed and protected against the effect of atmospheric conditions including the effect of direct sunlight. Too dry or damp air may cause deformities to some parts of the furniture. Avoid placing the furniture on damp surface.

Stop using them in case of easing (unscrewing) of screws, bolts or nuts.

Please Keep this for Future Reference!

PRODUCT CHECK

Upon receiving the furniture, please check product size, carton quantity.

TY-S0408 set should be packaged in 2 cartons. The shipping mark to be show on 1 of 1 & 2 of 2.

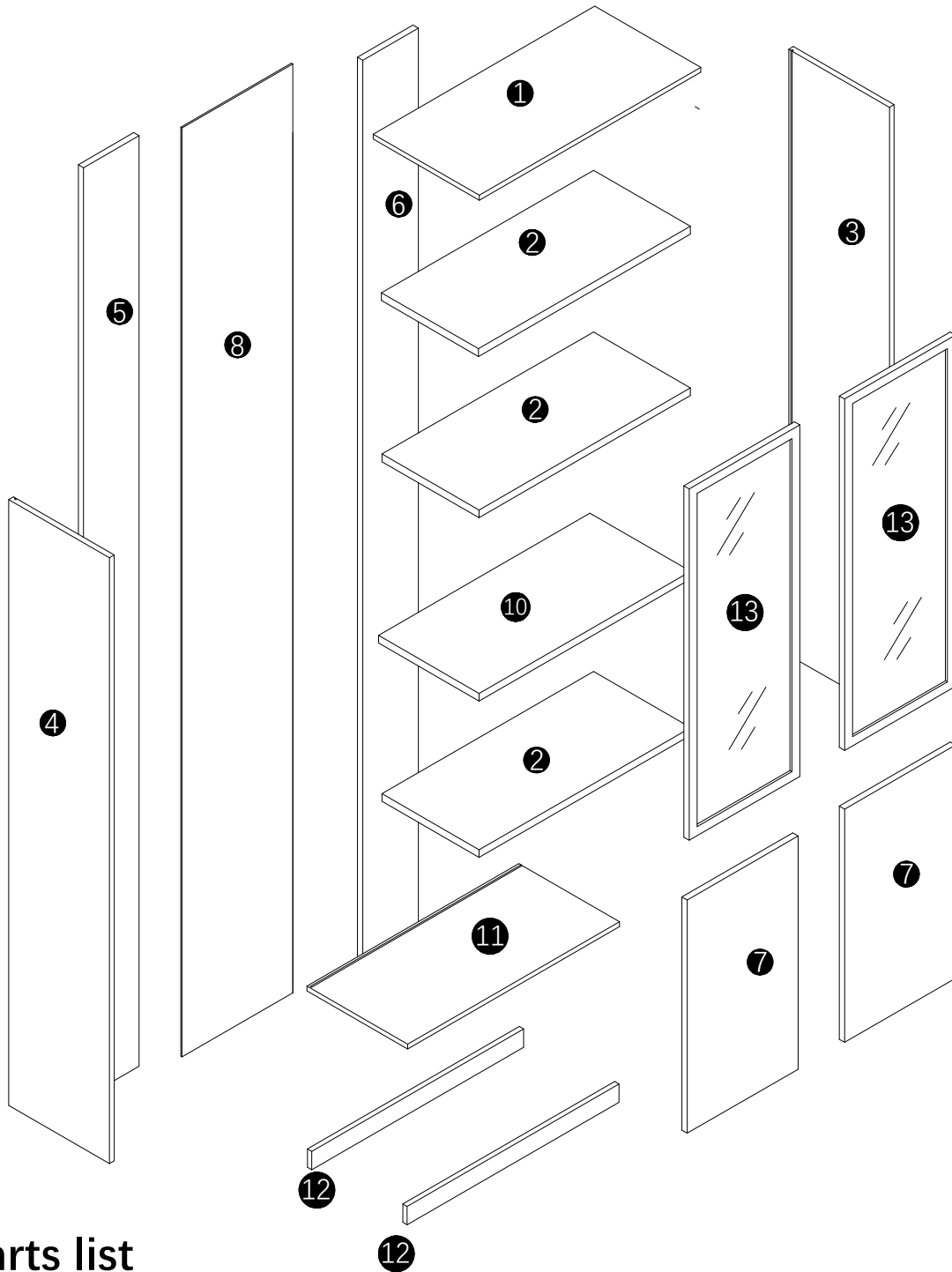







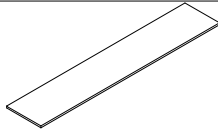
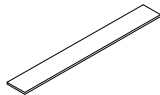
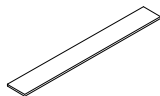
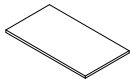
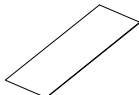
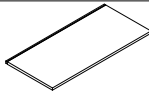
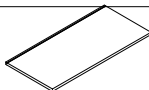
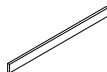
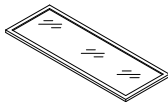







■ Parts list

NO.	Description	Dimension	QTY	Drawing
1	Top panel	800*400*16	1	
2	Moveable shelf pane	764*380*16	3	
3	Right side panel	1979*380*16	1	

■ Parts list

NO.	Description	Dimension	QTY	Drawing
4	Left side panel	1979*380*16	1	
5	Left back panel	1903*187*16	1	
6	Right back panel	1903*187*16	1	
7	Wooden door panel	769*397*16	2	
8	Mid back panel line	1917*397*4	1	
10	Fixed layer	754*380*16	1	
11	Bottom panel	754*380*16	1	
12	Leg panel	764*60*16	2	
13	Glass door panel	1146*397*16	2	

■ Fixing List

NO.	Description	Size(MM)		QTY	NO.	Description	Size(MM)		QTY
A1	Cam	Ø15*11.5		24	A2	Pin	Ø6*32		24
B	Wood plug	Ø8*30		12	C	Lock			1
D	Lock plate			1	E	Wooden door hinge			4
F	Glass door hinge			6	G	Large flat head bolt	M4*20		4
H	Self tapping screw	3.5*12		20	I	Self tapping screw	4*16		95
J	Shelf Pin	26*12*8		12	K	Cam sticker			24
L	Handle			4	M	Large flat head bolt	M4*8		4
N	Plastic fixed connector			16					

PIN INSTALLATION AS BELOW:

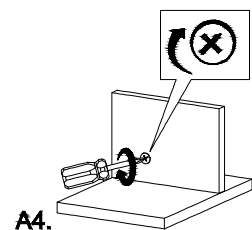
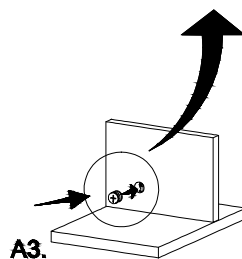
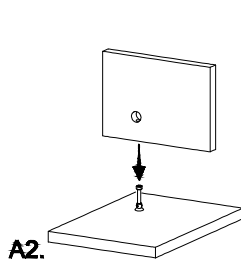
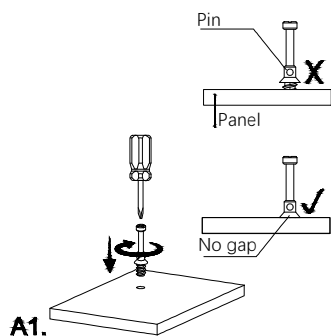
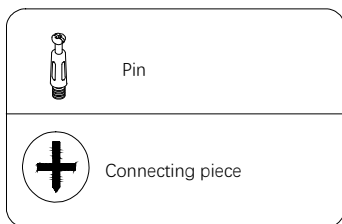

■ Assembly Steps

1

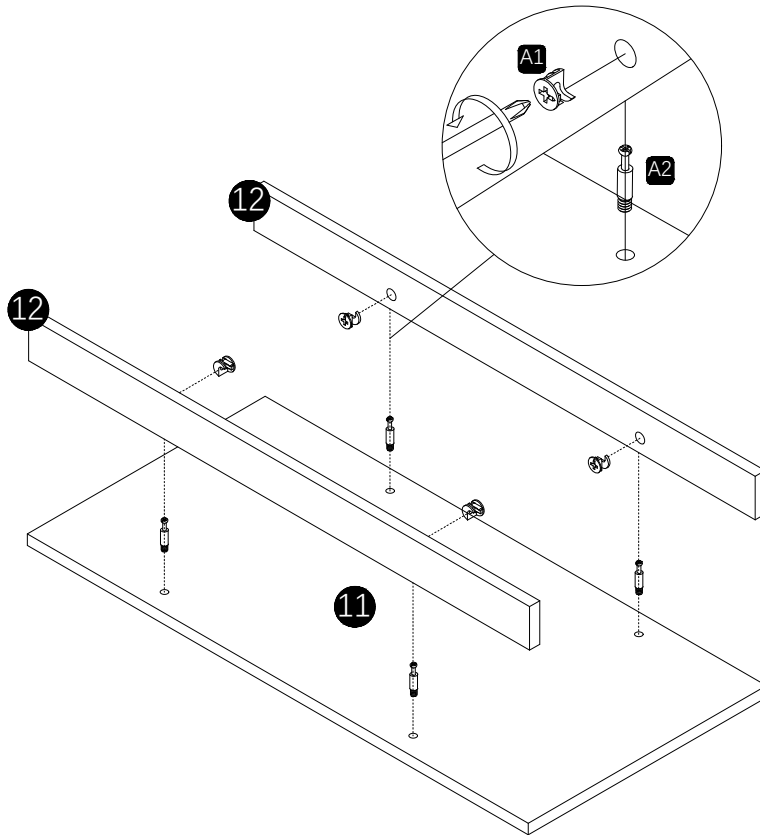

■ SCREWS

A1 $\varnothing 15 \times 11.5$

 X 4

A2 $\varnothing 15 \times 11.5$

 X 4

K $\varnothing 20$

 X 4



2

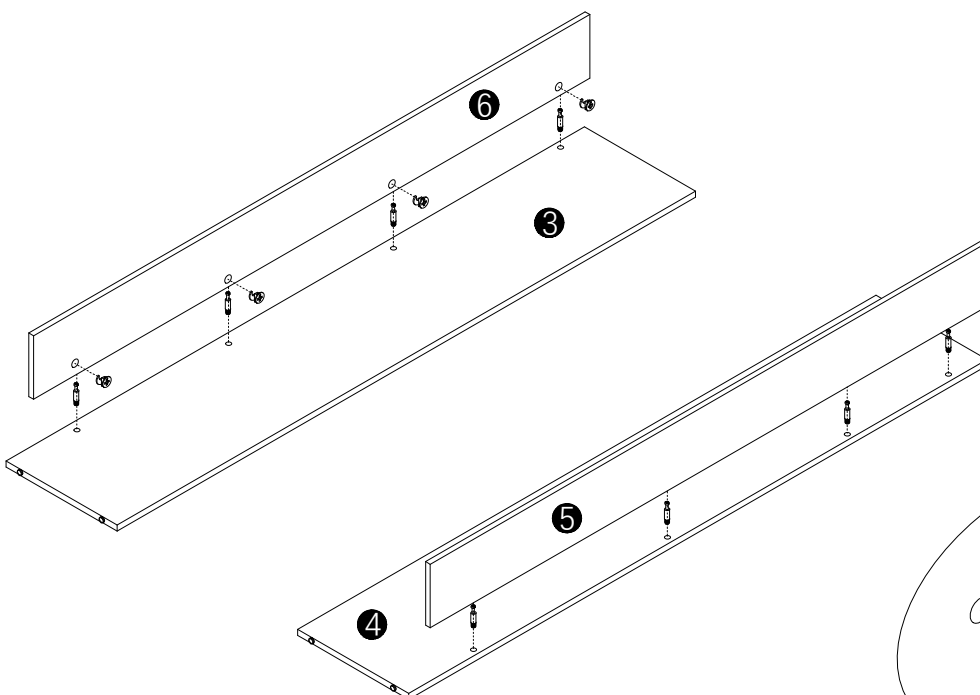

■ SCREWS

A1 $\varnothing 15 \times 11.5$

 X 8

A2 $\varnothing 15 \times 11.5$

 X 8

K $\varnothing 20$

 X 8



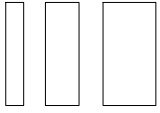

Assembly Steps

3

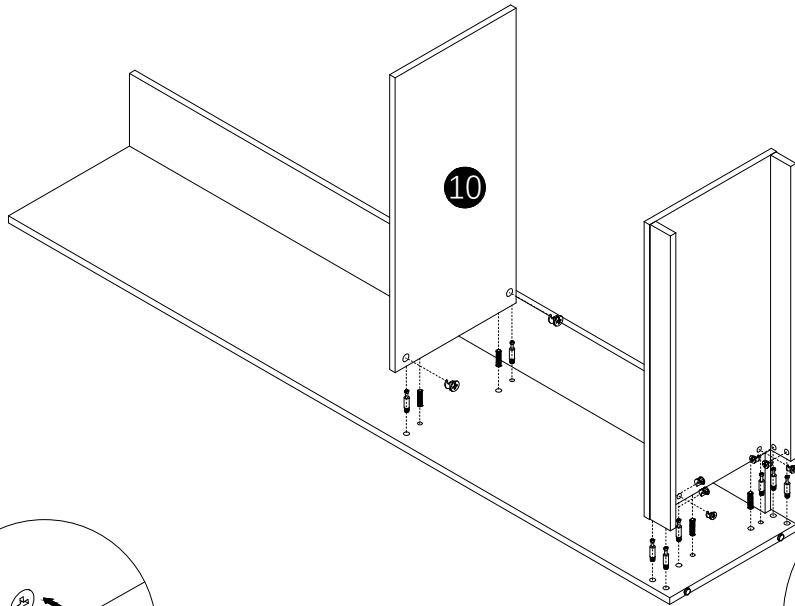

SCREWS	
A1	∅15*11.5
X 8	
A2	∅15*11.5
X 8	
B	∅8*30
X 4	
K	∅20
X 8	

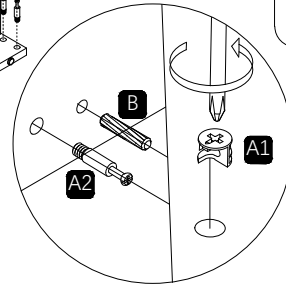

4

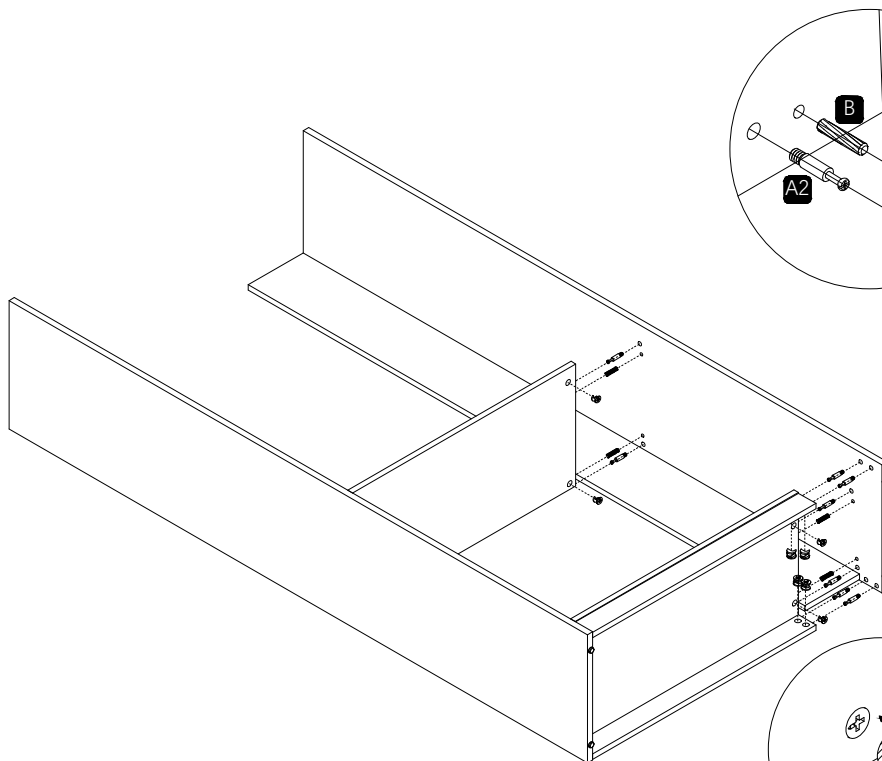

SCREWS	
A1	∅15*11.5
X 8	
A2	∅15*11.5
X 8	
B	∅8*30
X 4	
K	∅20
X 8	

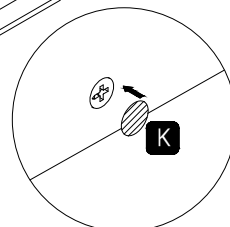
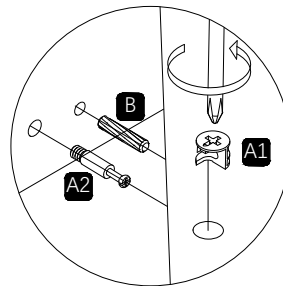

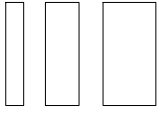

TY-S0408

P.8

■ Assembly Steps

5

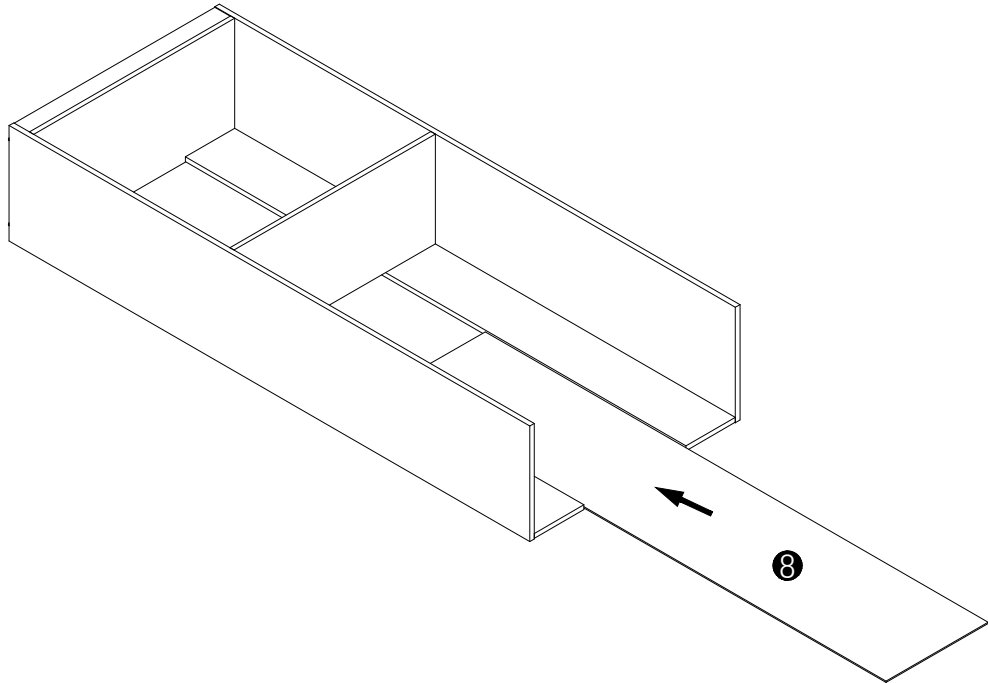

6

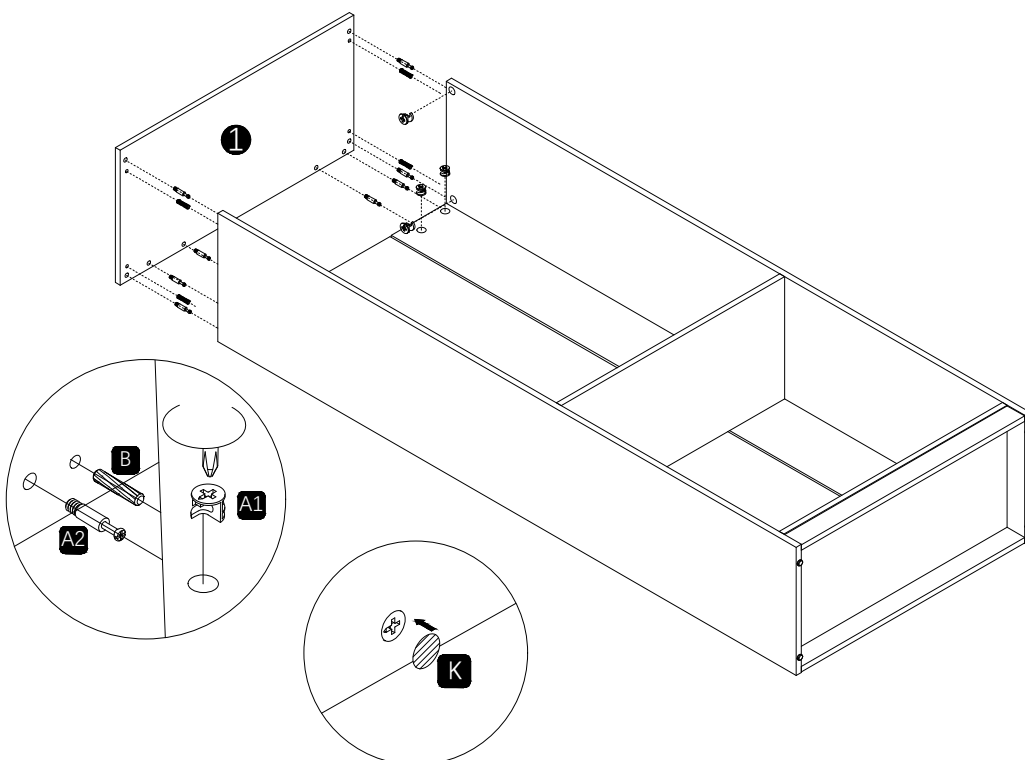

■ SCREWS

A1 $\varnothing 15 \times 11.5$

 X 8

A2 $\varnothing 15 \times 11.5$

 X 8

B $\varnothing 8 \times 30$

 X 4

K $\varnothing 20$



 X 8

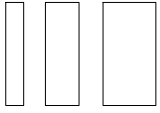



■ Assembly Steps

7

■ SCREWS	
H	3.5*12
	X 2
D	
	X 1
	

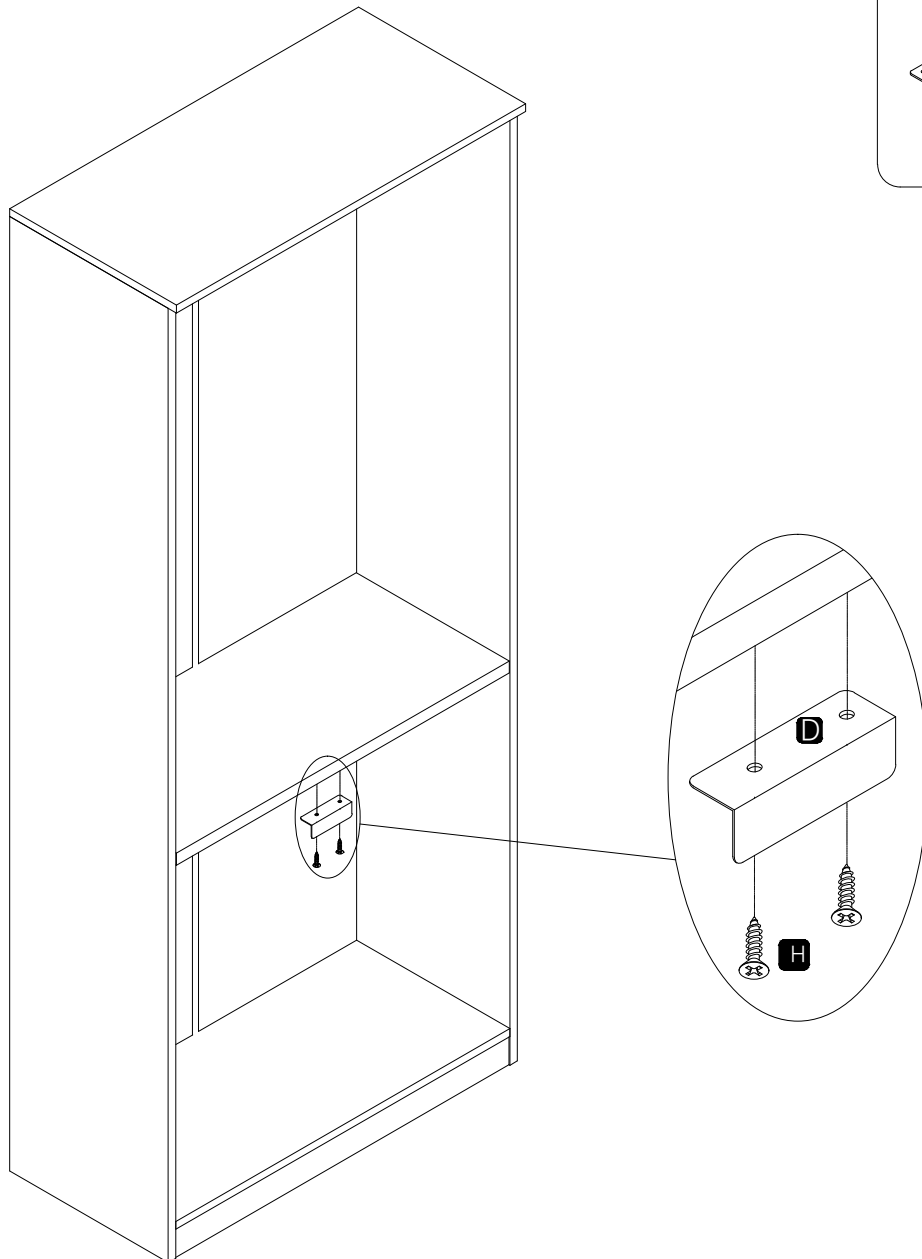

Assembly Steps

8

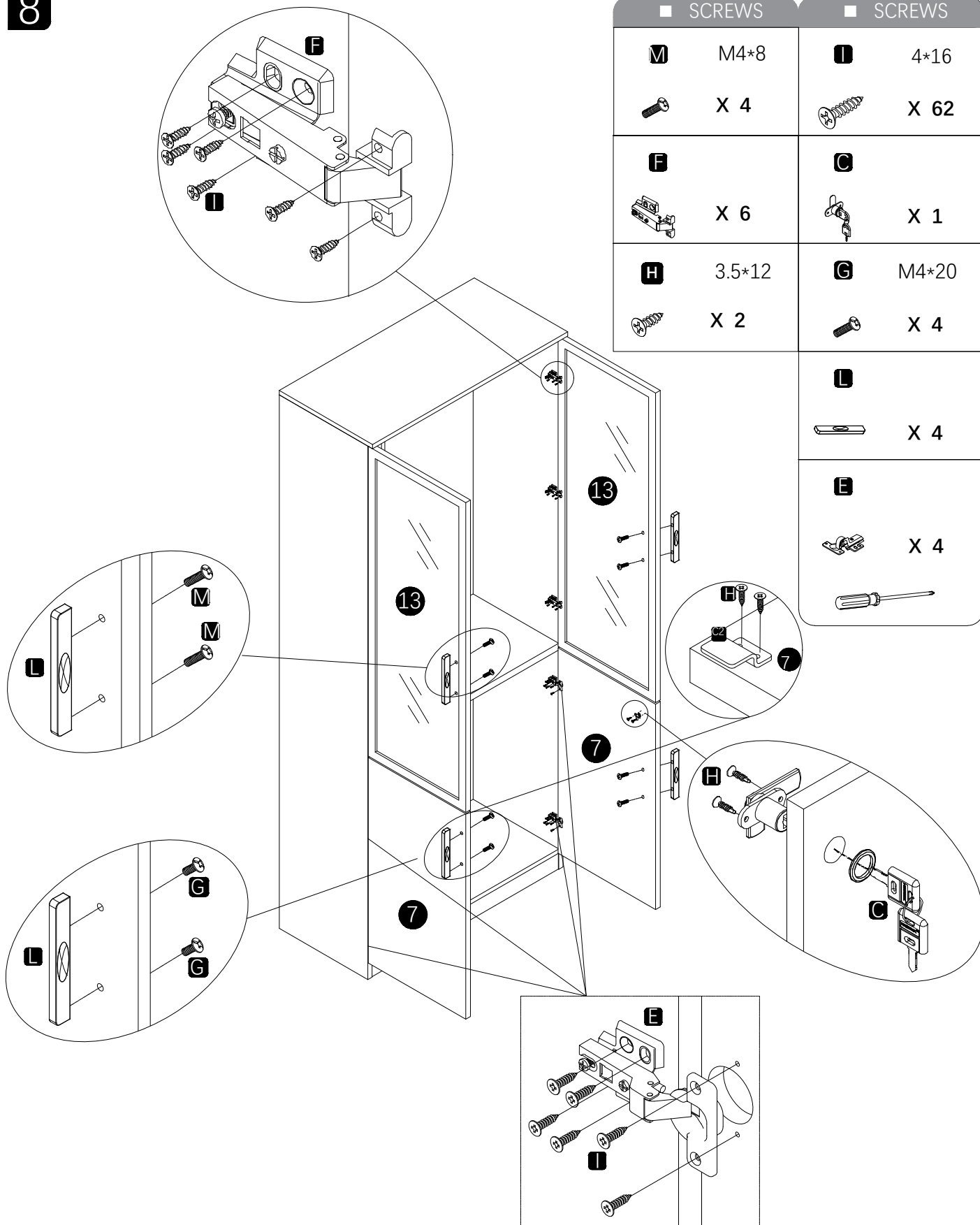

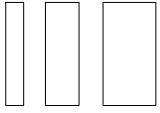



TY-S0408

P.11

■ Assembly Steps

9

■ SCREWS	
	26*12*8
	X 12
	

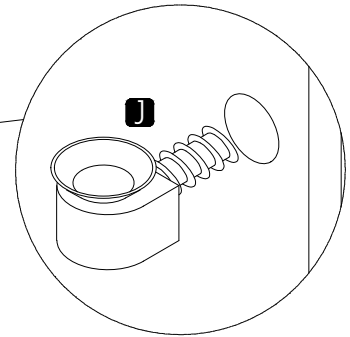
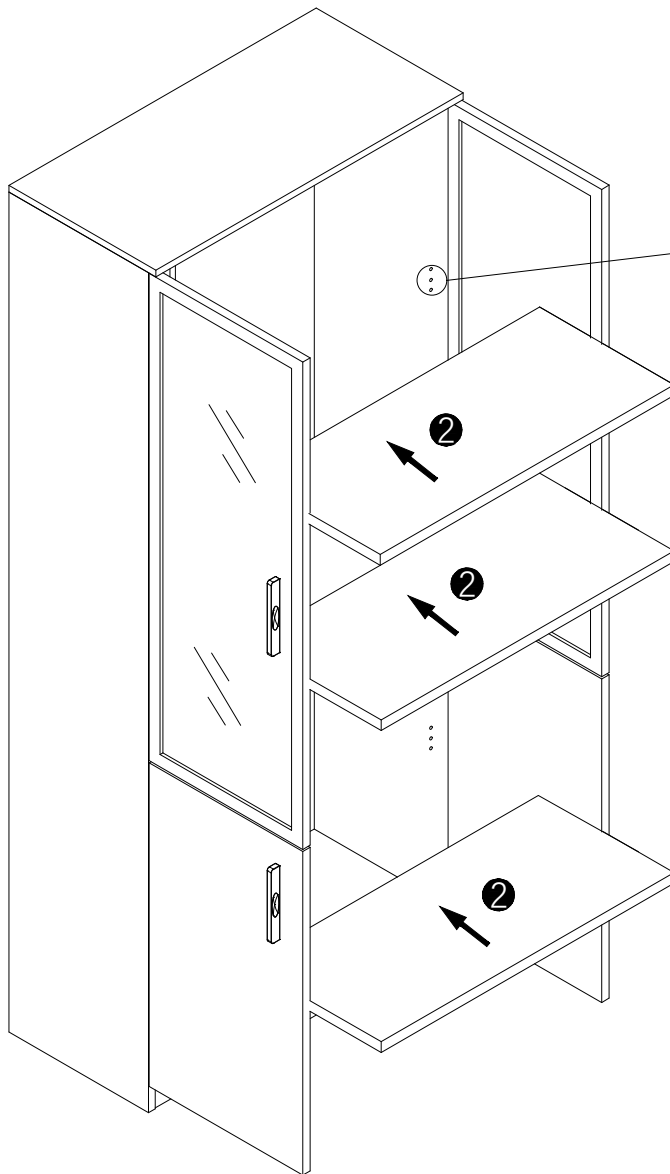

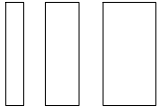





TY-S0408

P.12

■ Assembly Steps

10

■ SCREWS	
	
	X 12
	3.5*12
	X 12
	

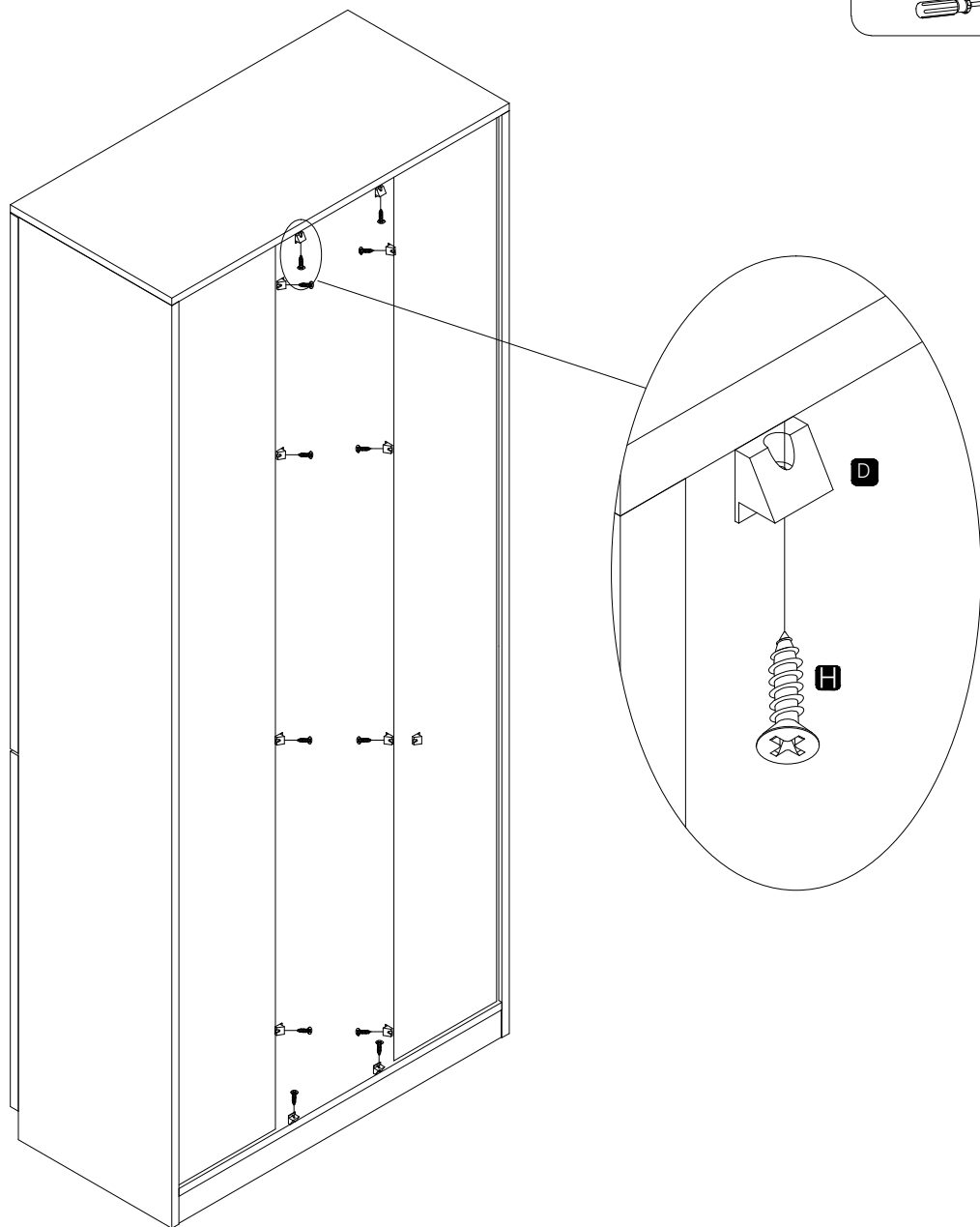

FINAL NOTE:

Do not drag the furniture as this may cause damage to the legs. Instead, ask at least 2 persons to lift carefully with caution from either end.

IMPORTANT: CARE GUIDE FOR YOUR MELAMINE BOARD FURNITURE

Please read up on important information regarding your furniture.

- Dust frequently with a clean damp, lint , free cloth.
- Avoid using chemicals or solvents when cleaning the furniture.
- Do not place hot objects on any furniture surface.
- Avoid exposing your furniture to strong sunlight.
- Do not expose your furniture to any liquids.
- Do not allow sharp or rough object scratch the surface of furniture.
- When moving furniture, do not drag it across the floor.