











## ASSEMBLY INSTRUCTION

**MODEL : CF 5018 - C  
2 SEATER**

A		1 pc
B		2 pcs
C		2 pcs
D		1 pc
E		4 pcs
F		8 pcs
G		16 pcs
H		1 pc
I		1 pc
J		4 pcs

Step 1 : Attach the arm (B) to the back rest (A) by pushing the bracket down to fit it.

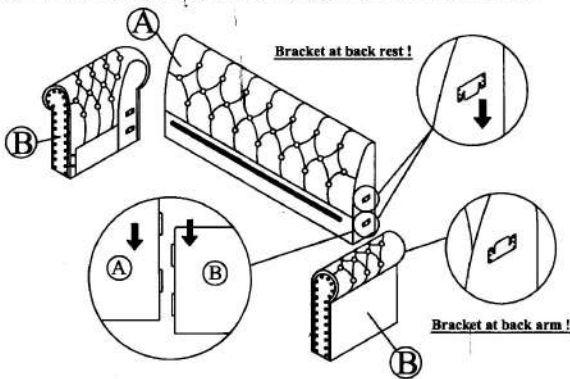

Step 2 : Attach the side rail (D) to the arm (B).

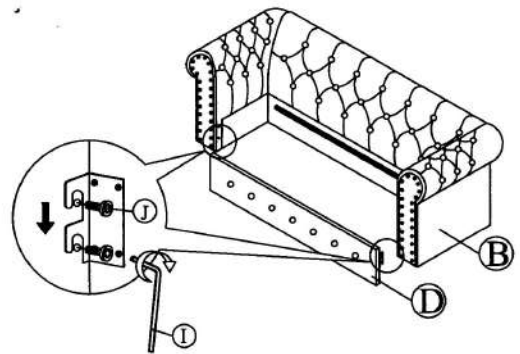

Step 3 : Attach the black woven (H) to the bottom the back rest (A), arm (B) and side rail (D).

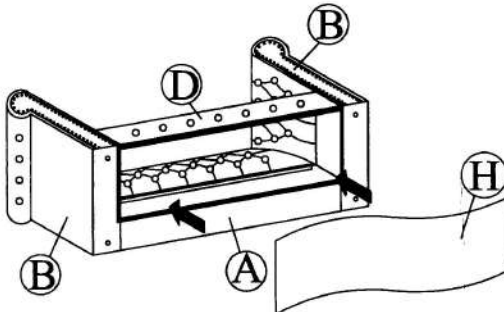

BOTTOM VIEW

Step 4 : Install the legs (E) to the arm (B).

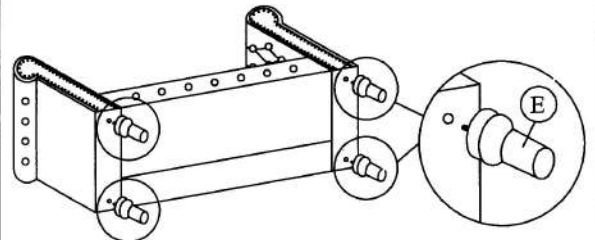

BOTTOM VIEW

Step 5 : Assembly of the slat holders with LVL slats as shown. Attach the sitter (C) to the arm (B), side rail (D) and back rest (A).

