

CHESTER OTTOMAN KING BED

ASSEMBLY INSTRUCTIONS

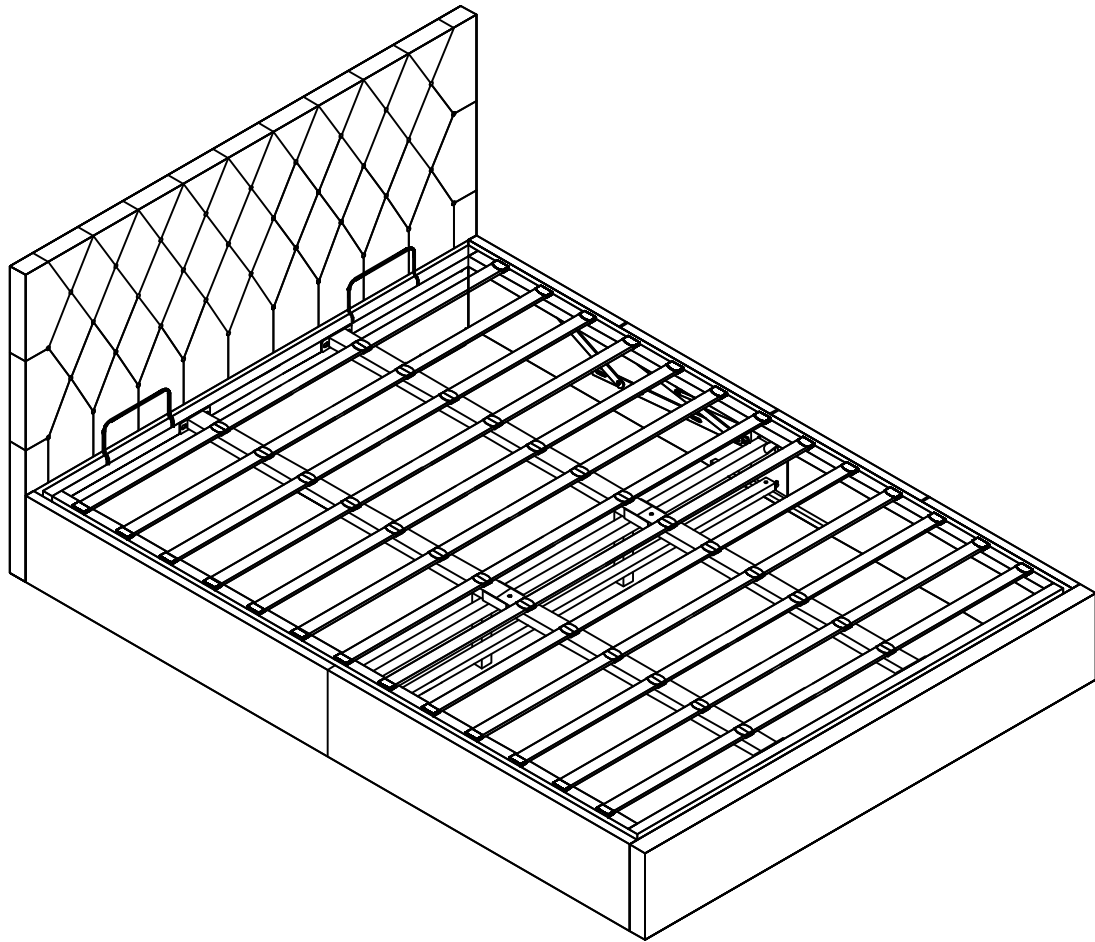

**CHESTER OTTOMAN KING BED IS FOR DOMESTIC USE
AND STRICTLY NOT FOR CONTRACT USE.**

PLEASE ASSEMBLE THE BED BY TWO PERSONS.

PART LIST

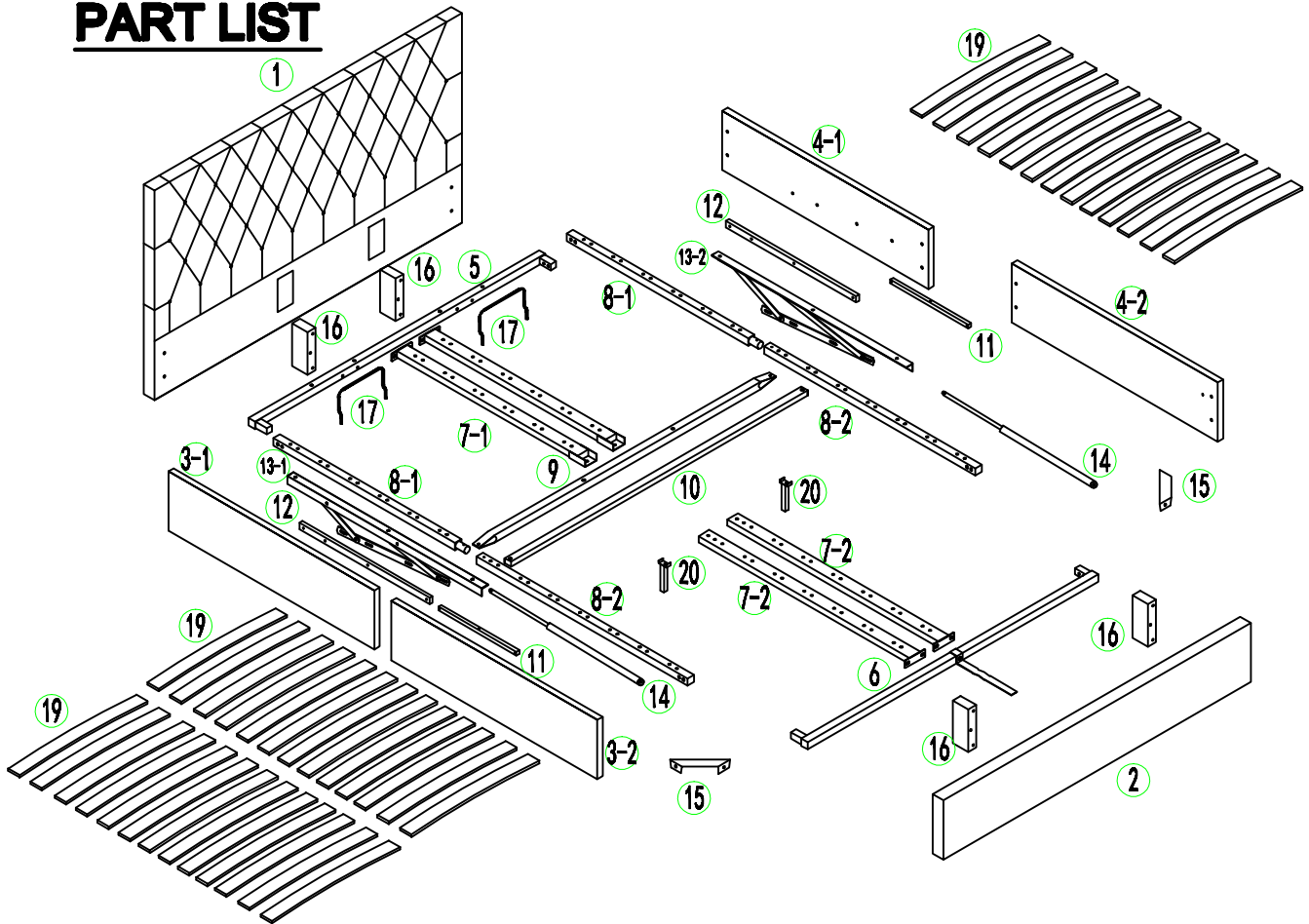

HARDWARE LIST

Label	Picture	Description	Qty	Label	Picture	Description	Qty
A		Single Plastic CAP	26	I		Bolt M6x60	2
B		Double Plastic CAP	26	J		Screw 4*80	12
C		Bolt M6x20	20	L		Connection Plate Left	2
D		Bolt M8x25	8	R		Connection Plate Right	2
E		Spring Washer	8	M		Bolt M8x35	8
F		Washer M8	8	N		Bolt M8x15	22
G		Nut M8	4	S		Bolt M6x40	6
H		Connection	2	O		Nut M6	4
K		Bolt M6x35	2	P		Washer M6	4

TOOL list

Label	Picture	Description	Qty
T-1		Screw driver(not provided)	1
T-2		Allen key M5	1
T-3		Allen key M4	1
T-4		Spanner M8	1
T-5		Spanner M6	1

Steps 1

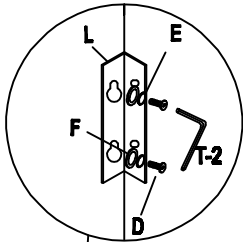

Steps 1b

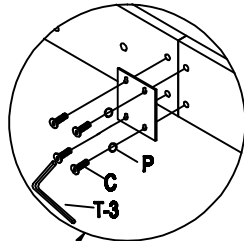

Steps 1a

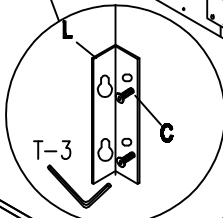

Steps 2c

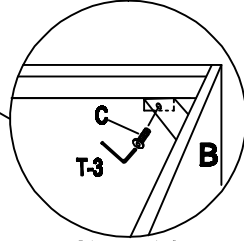

Steps 1d

L		2pcs	R		2pcs
Connection Plate Left			Connection Plate Right		
D		8pcs	E		8pcs
Bolt M8x25			Spring Washer		
F		8pcs	T-2		1pcs
Washer M8			Allen key 5#		
H		2pcs	T-3		1pcs
Connection			Allen key 4#		
C		20pcs	P		4pcs
Bolt M6x20			Washer M6		

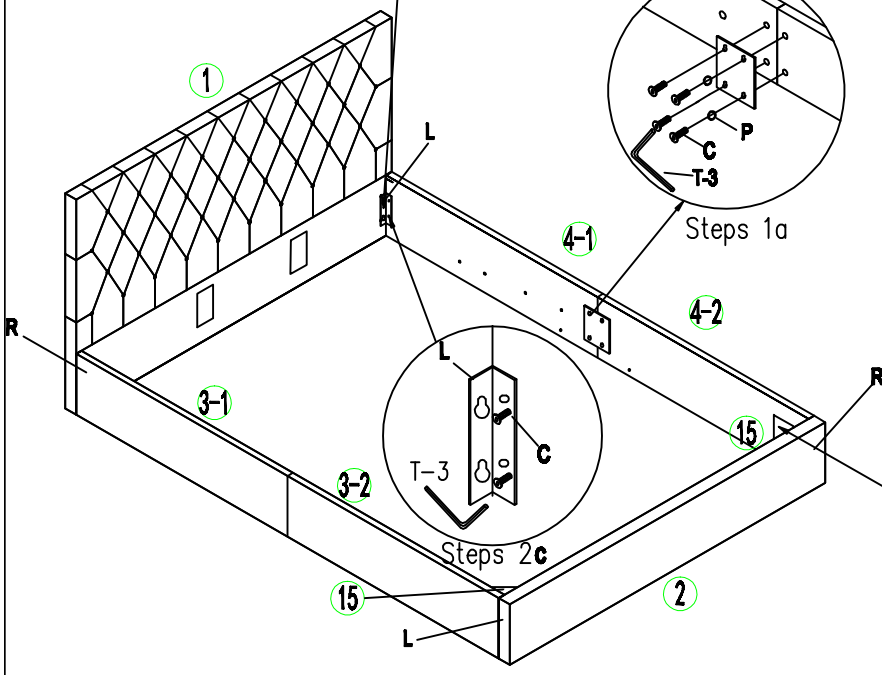

Steps 2

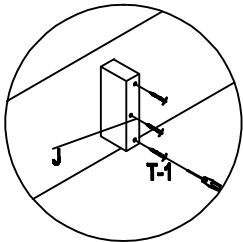

Steps 2a

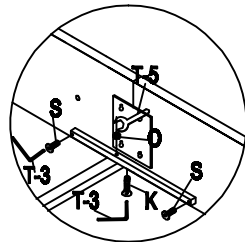

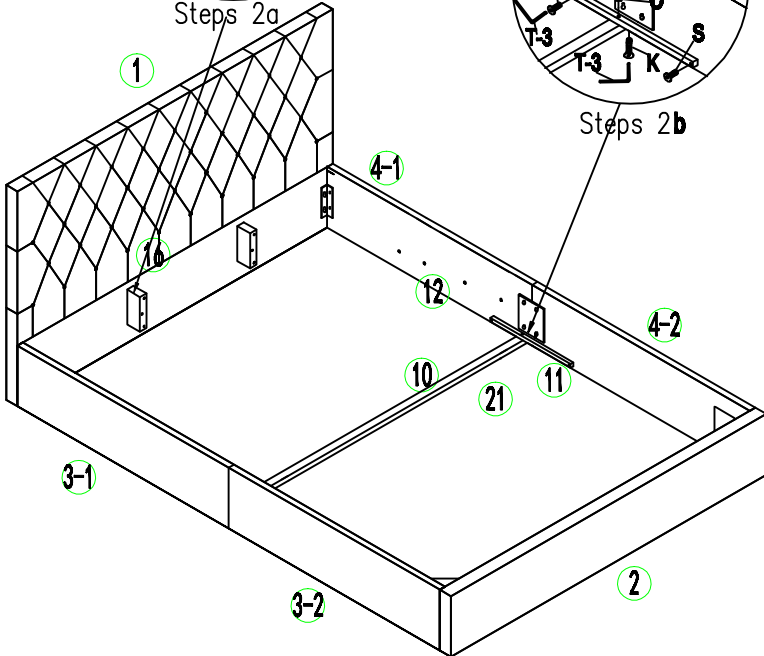

Steps 2b

J		12pcs	T-1		1pcs
Screw 4*80			Screw driver (not provided)		
K		2pcs	T-3		1pcs
Bolt M6x35			Allen key 4#		
O		2pcs	S		4pcs
Nut M6			Bolt M6x40		
			T-5		1pcs
			Spanner M6		







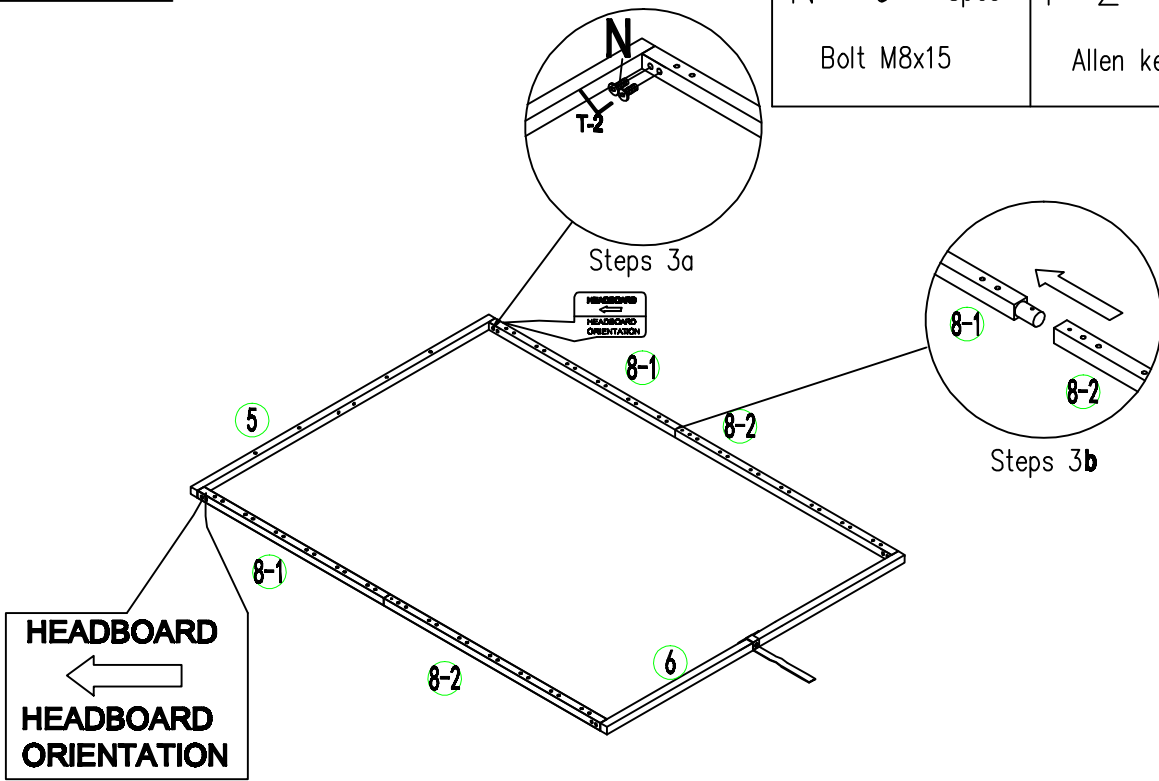

Steps 3

N	 8pcs	T-2	 1pcs
	Bolt M8x15		Allen key 5#



Steps 4

N	 6pcs	T-2	 1pcs
	Bolt M8x15		Allen key 5#
M	 8pcs	S	 2pcs
	Bolt M8x35		Bolt M6x40
		O	 2pcs
			Nut M6
		T-5	 1pcs
			Spanner M6
		T-3	 1pcs
			Allen key 4#

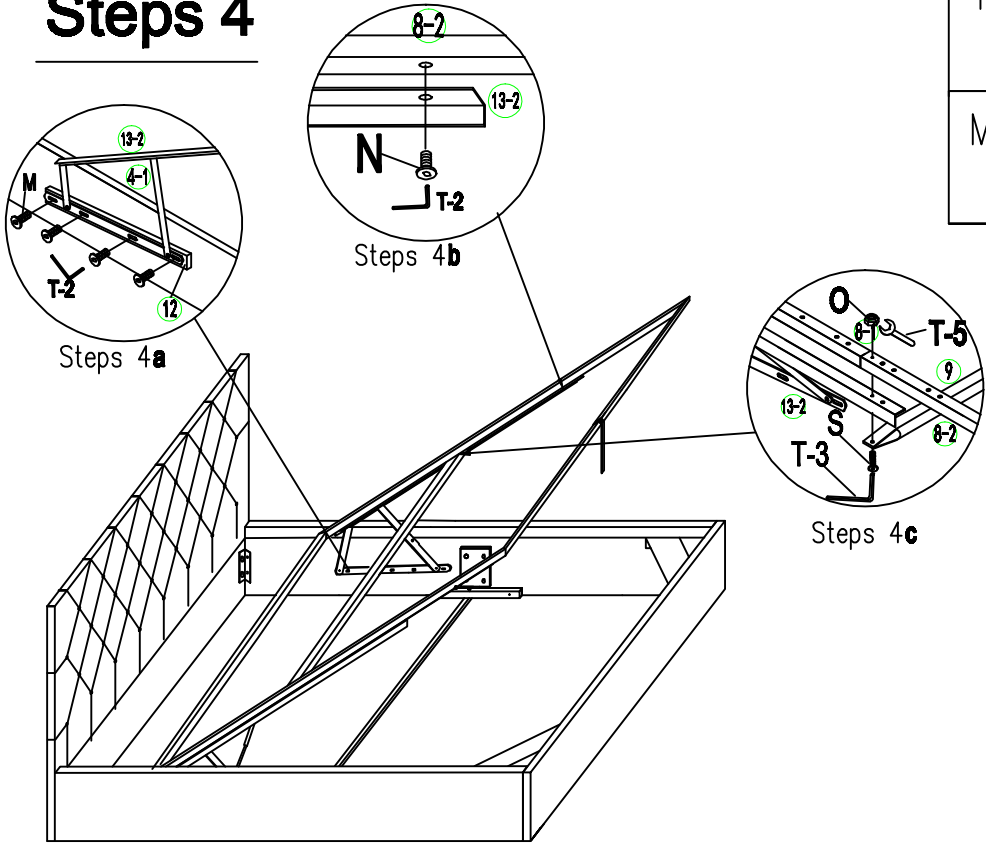

Steps 5

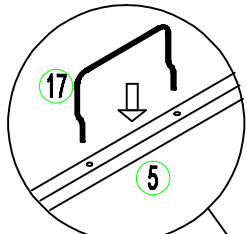

Steps 5e

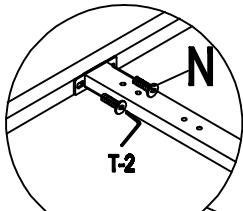

Steps 5b

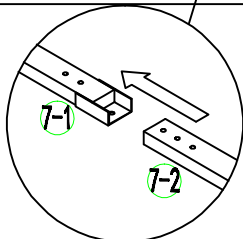
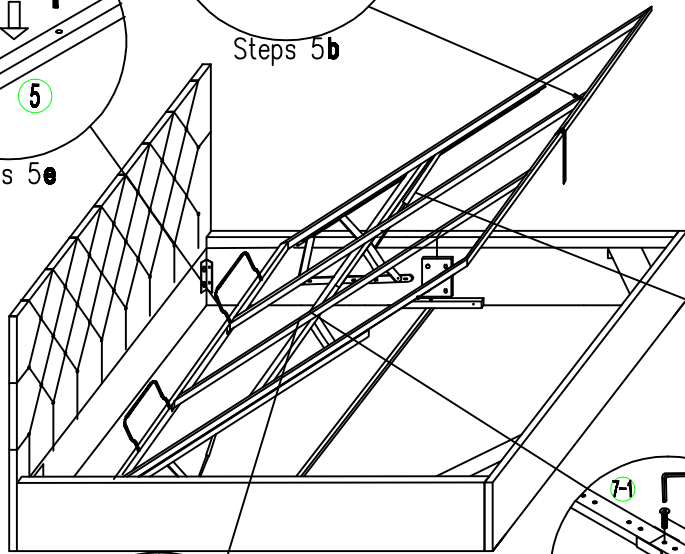



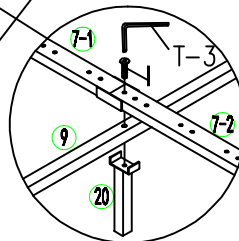

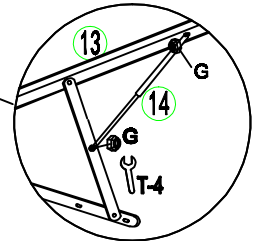

Steps 5c





Steps 5d



Steps 5a

G  4pcs Nut M8	T-4  1pcs Spanner M8
I  2pcs Bolt M6x60	T-3  1pcs Allen key 4#
N  8pcs Bolt M8x15	T-2  1pcs Allen key 5#

A  26pcs Single Plastic CAP	B  26pcs Double Plastic CAP
--	--

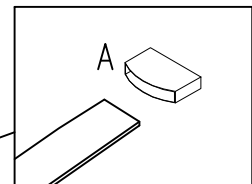
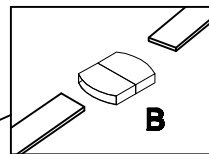
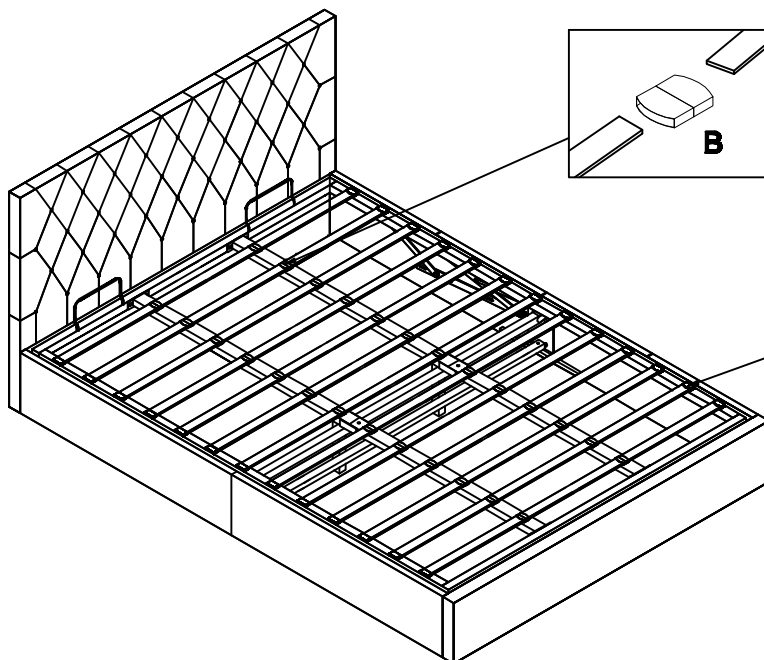

Steps 7

PASTE NON WOVEN FABRIC TO THE BOTTOM OF THE BED

