

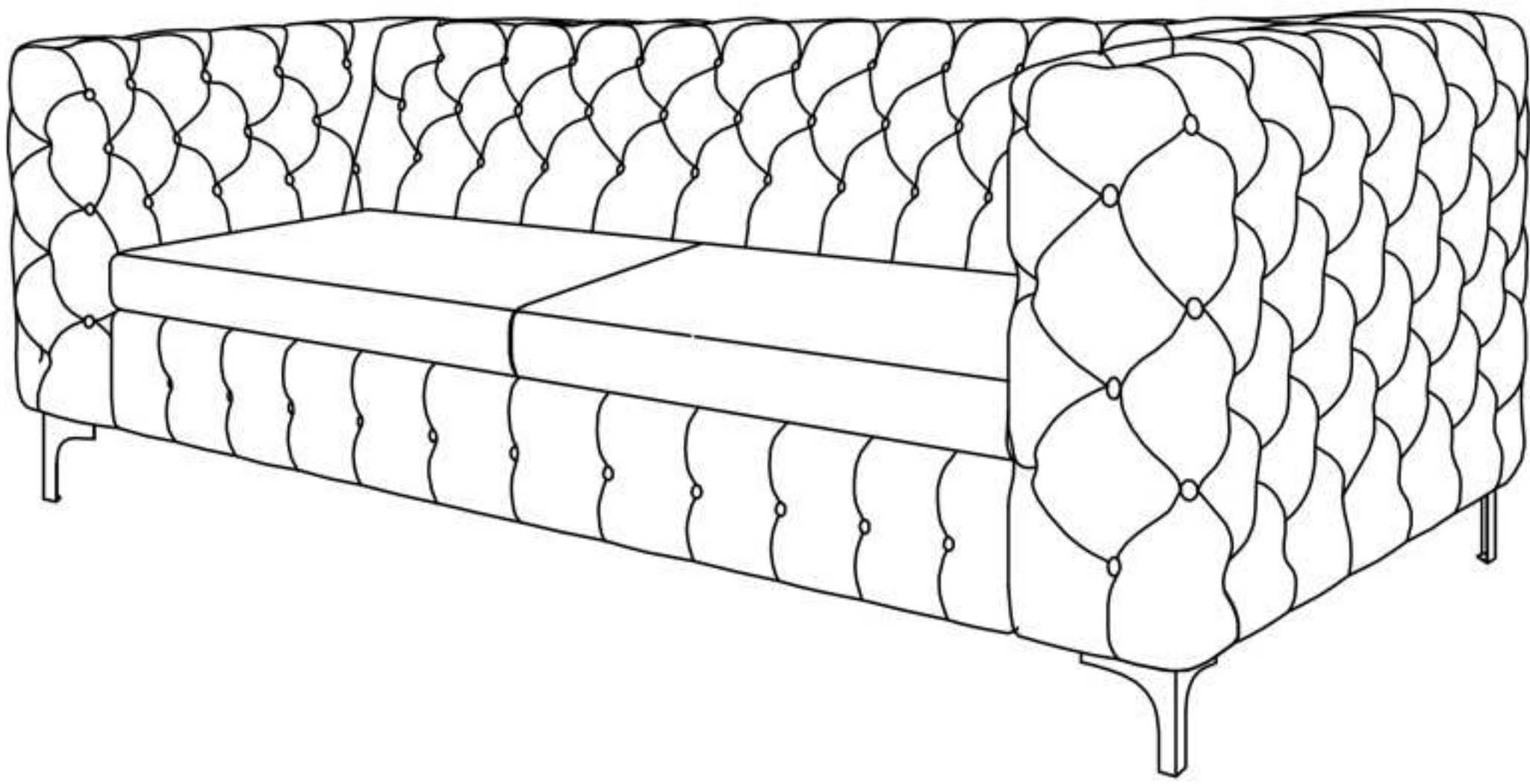

ASSEMBLY INSTRUCTION

“Must not drag or push after assembly. Please always lift the item for moving”.





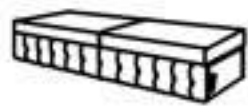
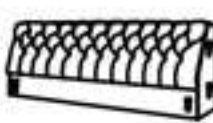
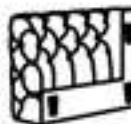

Do not tighten screws until completely assembled.

PARTS IDENTIFICATION

NO	Part	Specification	Quantity
1		Seat	1pc
2		Back	1pc
3		Handrail	2pcs
4		Legs	4pcs
5		Middle Foot	1pc

HARDWARE LIST

NO	Shape	Specification	Quantity
A		Allen Wrench 4mm	1pc
B		Bolt 5/16"x1-1/4"	8pcs
C		Lock Washer 5/16"x12mm	8pcs
D		Flat Washer 5/16"x22mm	8pcs

STEP 1

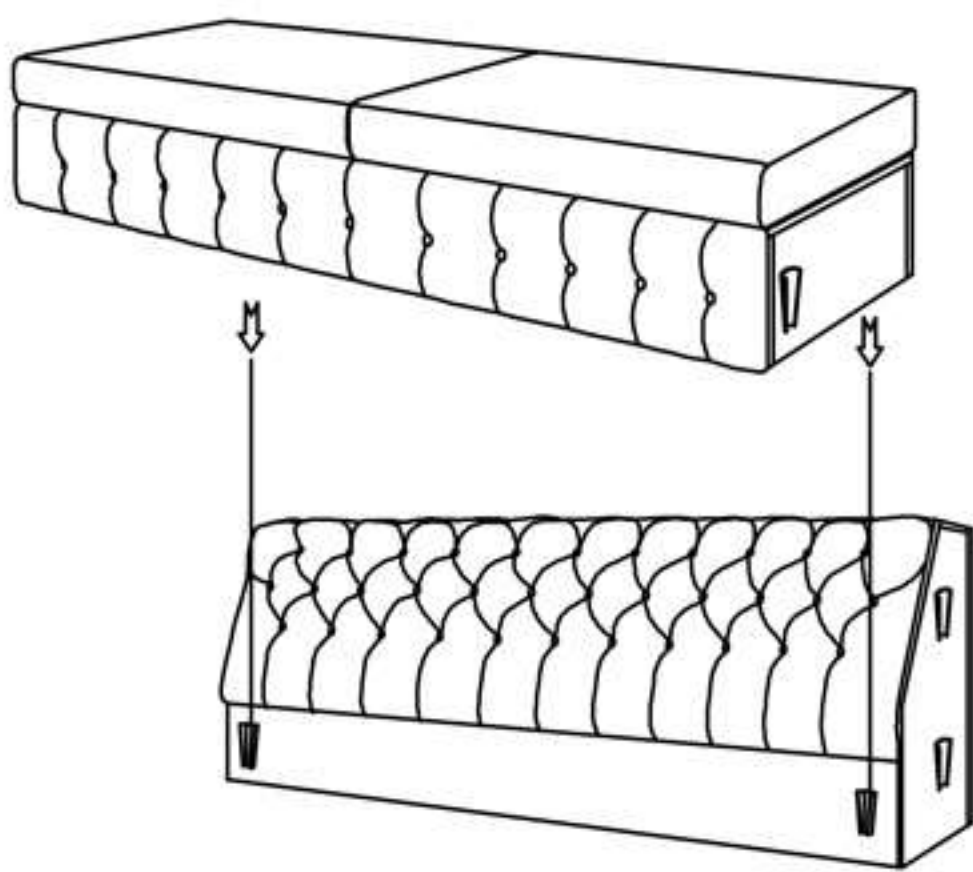

STEP 2

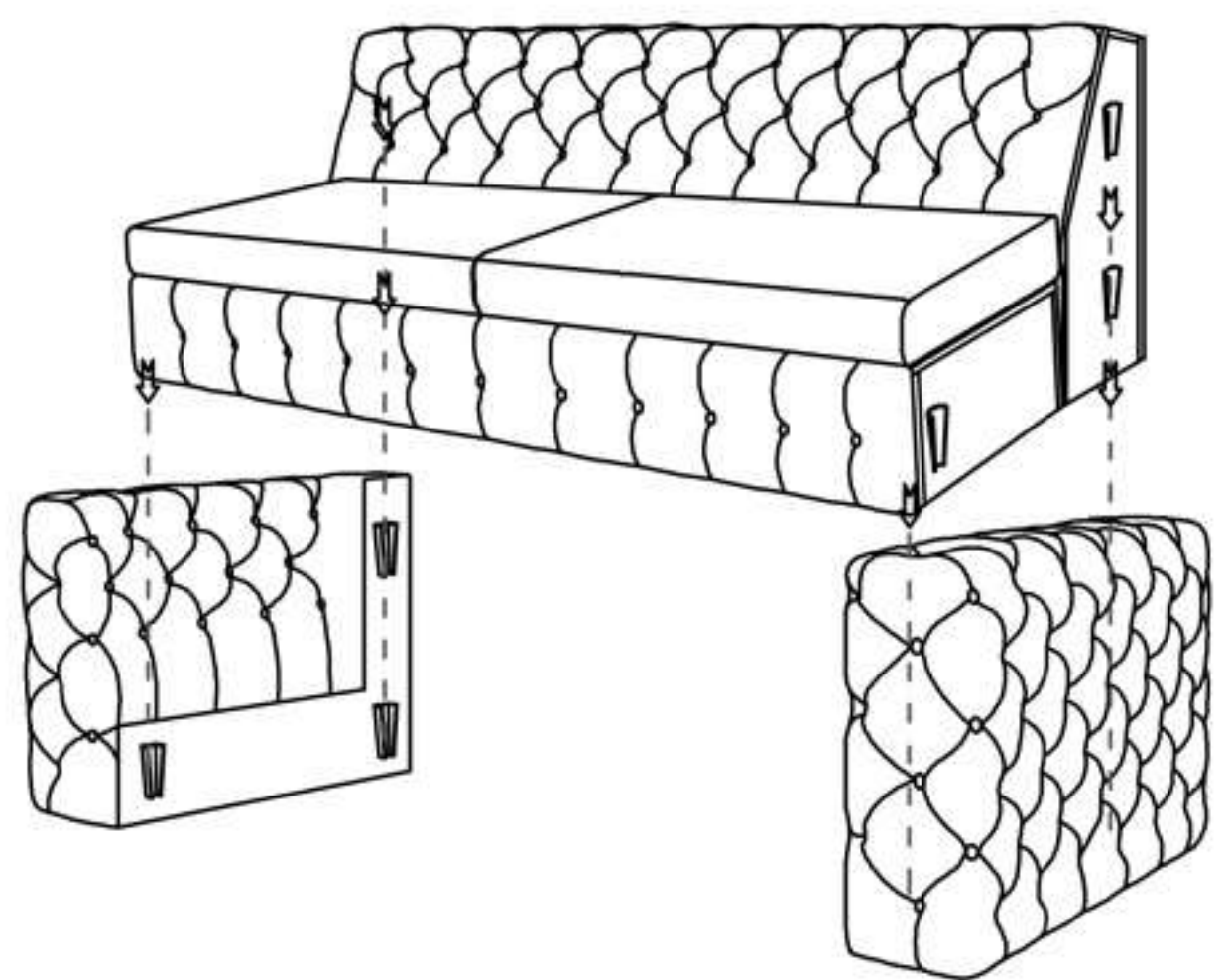

STEP 3

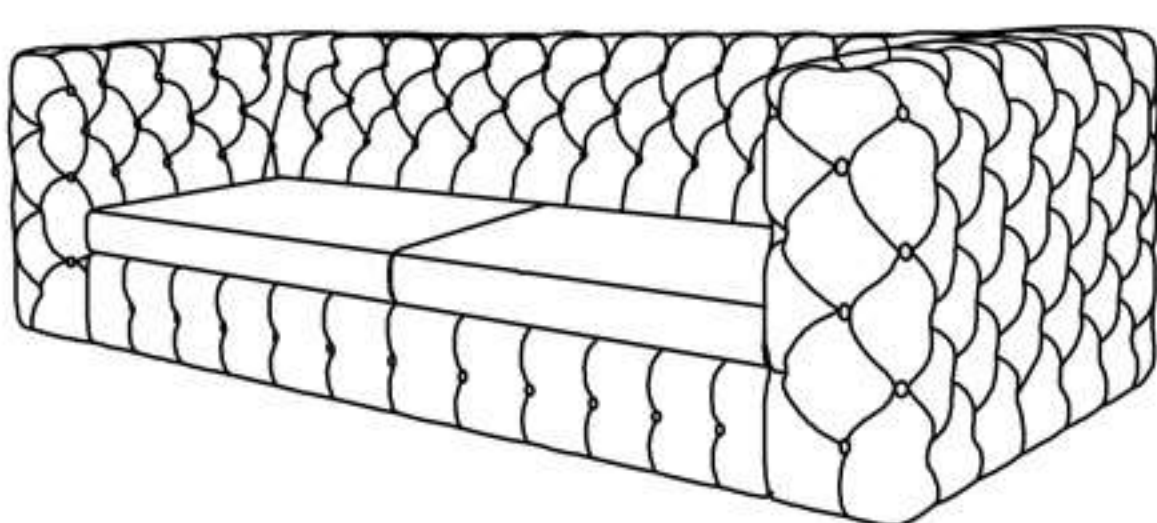

STEP 4

