

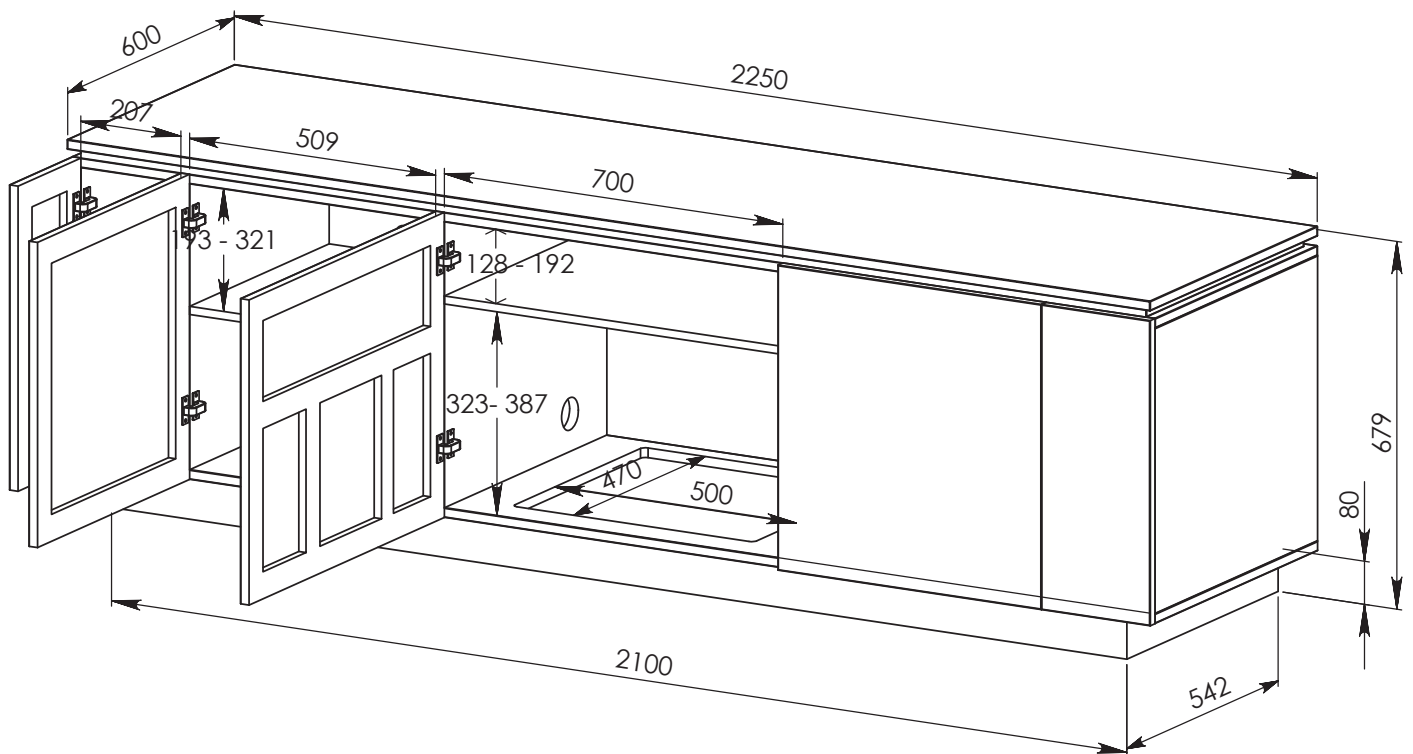

www.rvm.com.au

Assembly Instruction Manual

MODEL NO.: HOLLYWOOD2250











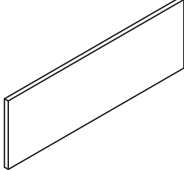
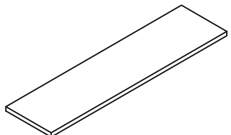
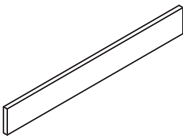
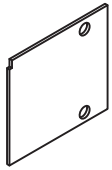
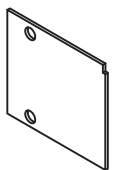
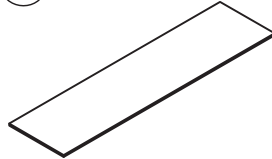
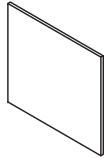
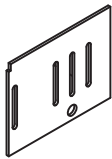
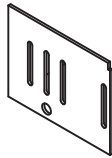
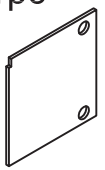
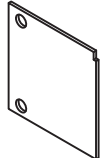
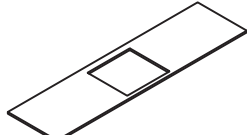
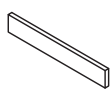
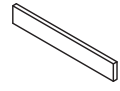
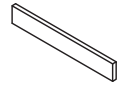
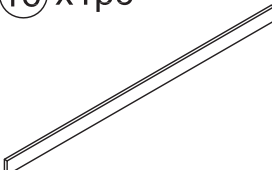
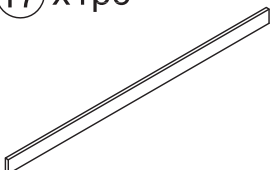
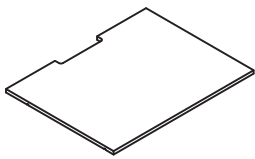
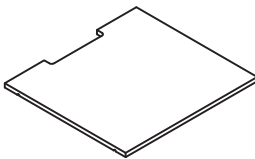
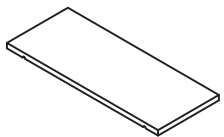
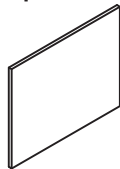
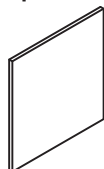

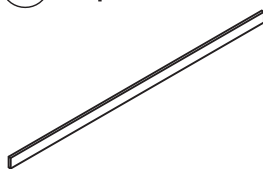
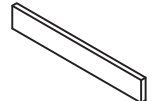
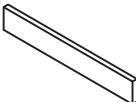
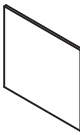

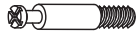
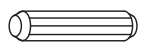
- Please follow these assembly instructions as it will save you time, make assembly easier and prevent possible damage to your new unit.
- We strongly recommend that the unit is assembled on a soft surface such as carpet or blanket.

as power tools can strip threads if over tightened.

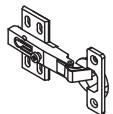
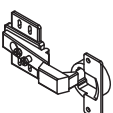
- Correct assembly is your responsibility.
- **When moving this furniture item, always carry the unit. Dragging or sliding the unit could damage the unit and the floor surface.**

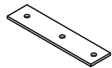
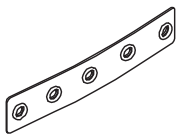
Part List:

① x1pc 	② x1pc 	③ x1pc 	④ x1pc 	⑤ x1pc 	
⑥ x1pc 	⑦ x1pc 	⑧ x1pc 	⑨ x1pc 	⑩ x1pc 	
⑪ x1pc 	⑫ x1pc 	⑬ x1pc 	⑭ x1pc 	⑮ x2pcs 	
⑯ x1pc 	⑰ x1pc 	⑱ x1pc 	⑲ x2pcs 	⑳ x2pcs 	
㉑ x1pc 	㉒ x2pcs 	㉓ x2pcs 	㉔ x1pc 	㉕ x1pc 	
㉖ x1pc 	㉗ x1pc 	㉘ x58pcs 	㉙ x58pcs 	㉚ x38pcs  ø8x30	
㉛ x14pcs  ø4x40	㉜ x4pcs  M6x25	㉝ x20pcs  ø 5x (10+10)	㉞ x64pcs  ø4x16	㉟ x4pcs 	
㊱ x6pcs 	㊲ x2pcs  ø7x38	㊳ x2pcs 	㊴ x2pcs 	㊵ x2pcs  M4x10	㊶ x4pcs  ø4x25

OVERVIEW

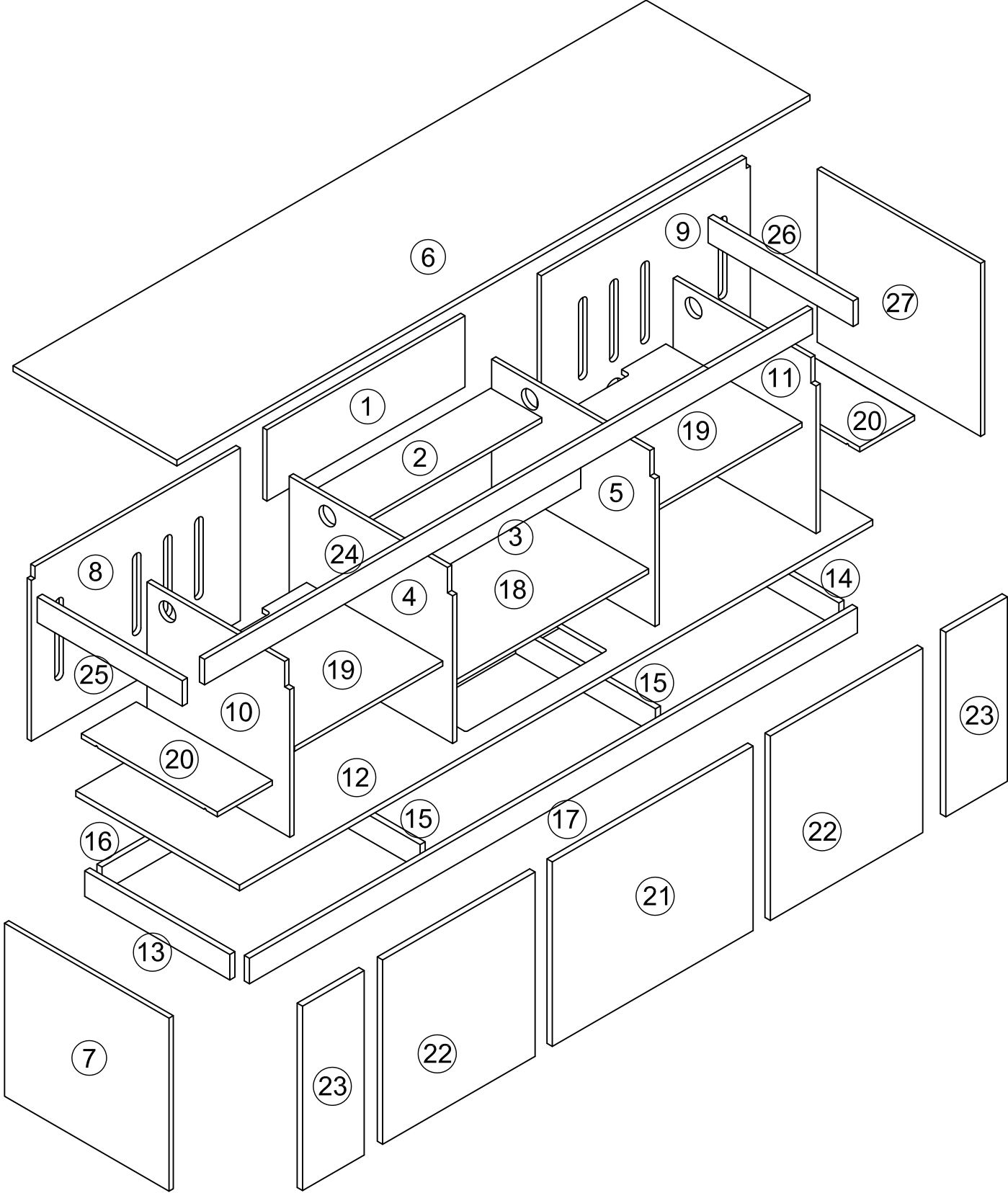

STEP 1



28 x4pcs

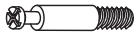

29 x4pcs



30 x4pcs

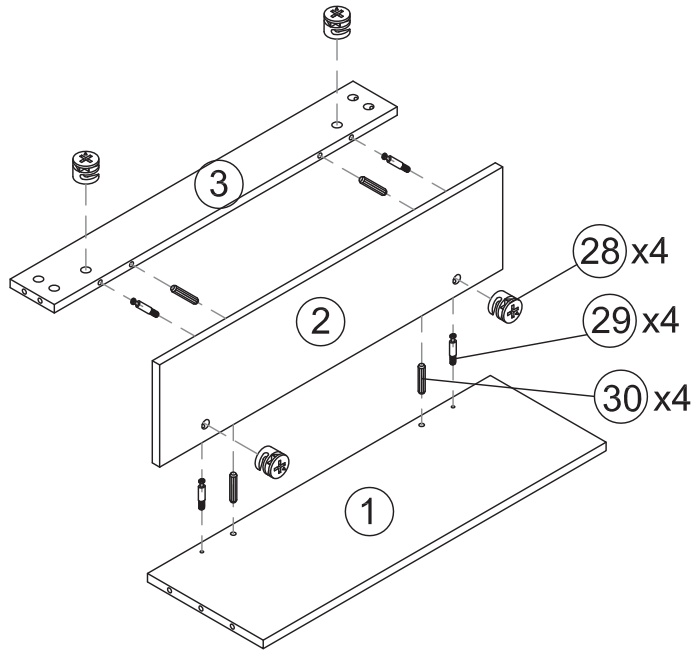

HINT

Cam fitting detail

When inserting cam, ensure arrowhead on cam points toward to the hole on the panel edge.



Arrowhead

STEP 2



28 x8pcs

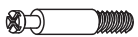

29 x8pcs

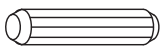

30 x2pcs

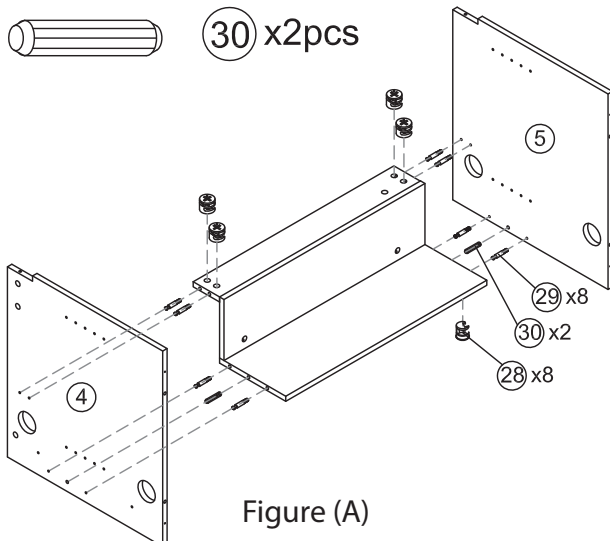
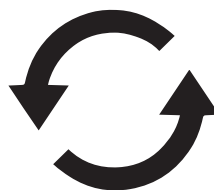

Figure (A)



Rotate cabinet as image shown in Figure (B)

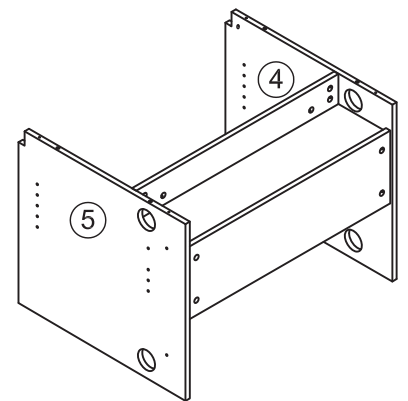

Figure (B)



HINT

Cam fitting detail

When inserting cam, ensure arrowhead on cam points toward to the hole on the panel edge.



Arrowhead

STEP 3



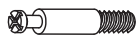

28 x4pcs

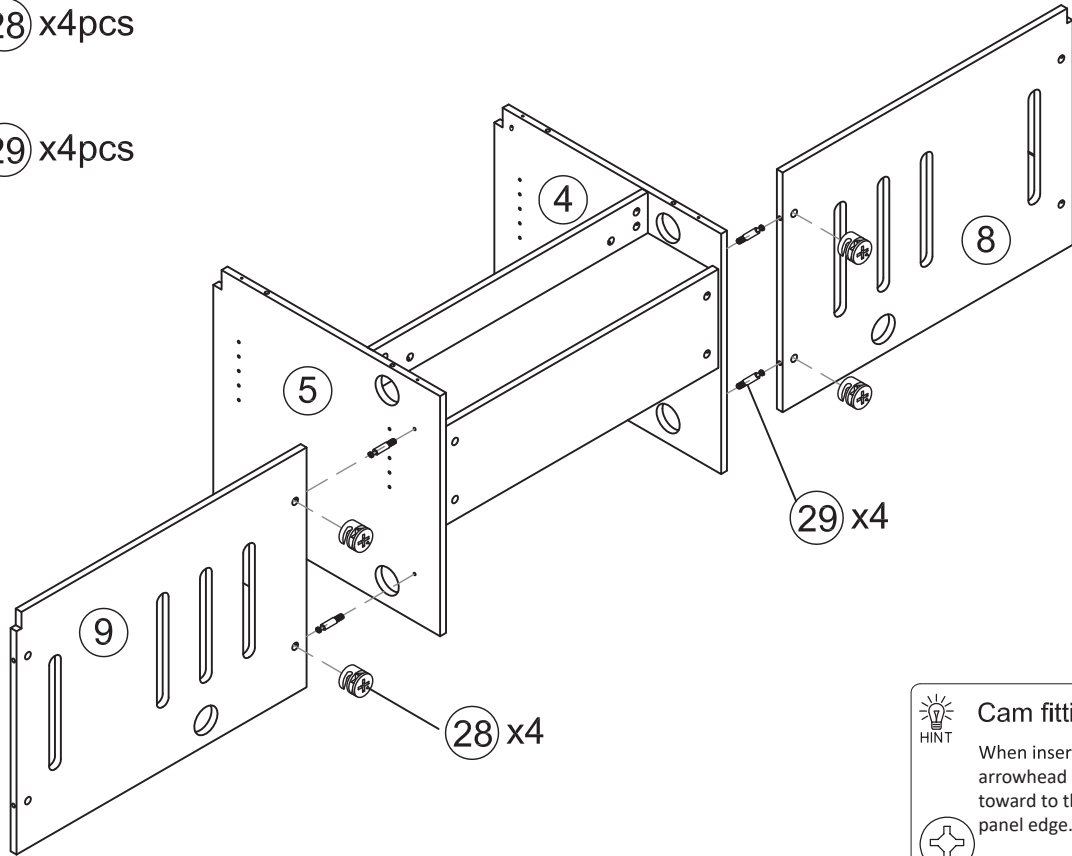

29 x4pcs



 **HINT** **Cam fitting detail**
When inserting cam, ensure arrowhead on cam points toward to the hole on the panel edge.



STEP 4



28 x4pcs

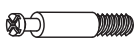

29 x4pcs

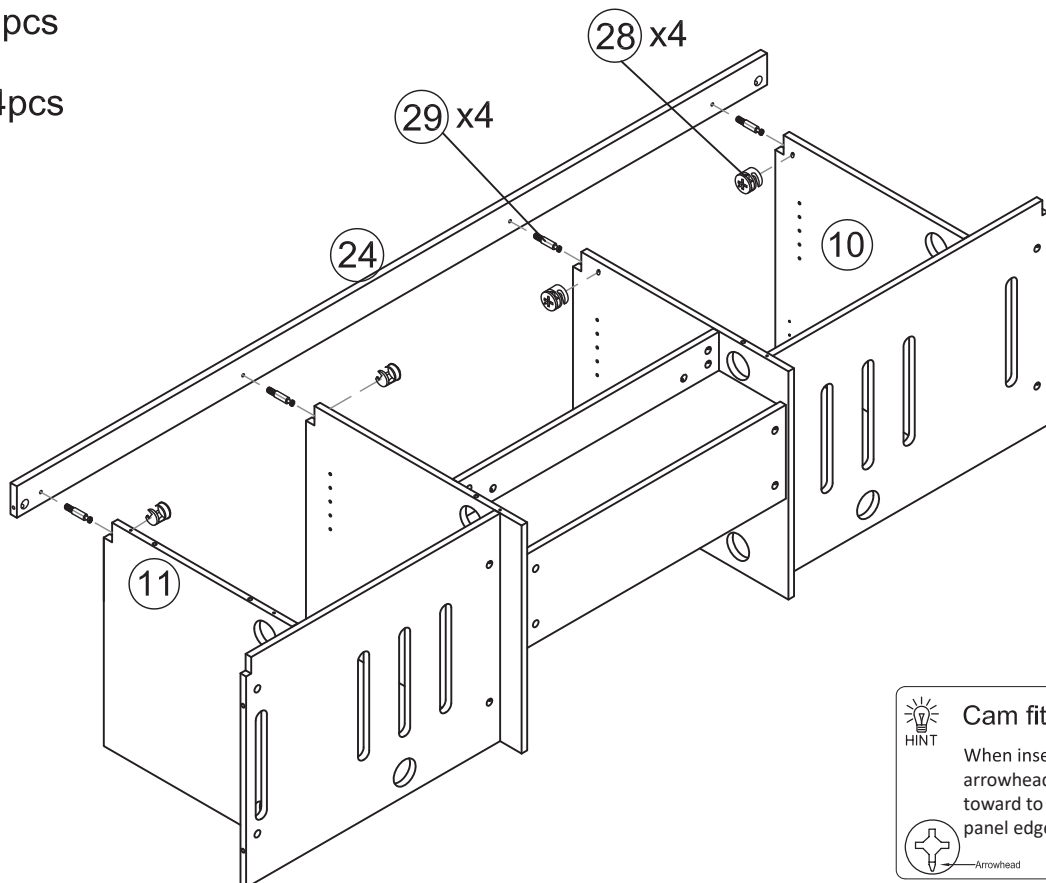

 **HINT** **Cam fitting detail**
When inserting cam, ensure arrowhead on cam points toward to the hole on the panel edge.

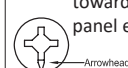

STEP 5



28 x6pcs

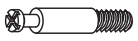



29 x6pcs

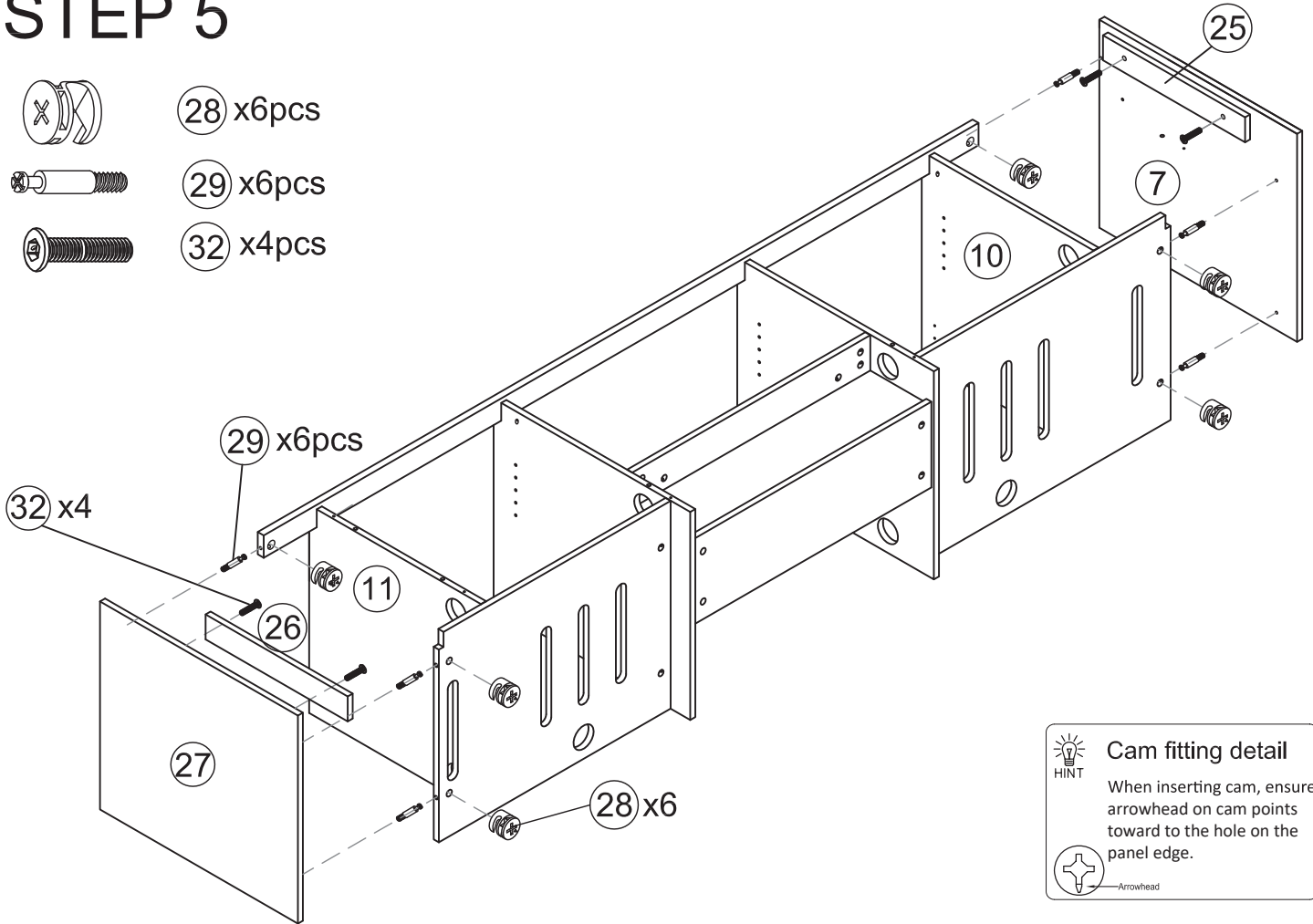

32 x4pcs



 **Cam fitting detail**
 HINT When inserting cam, ensure arrowhead on cam points toward to the hole on the panel edge.

 Arrowhead

STEP 6



28 x12pcs

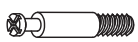

29 x12pcs

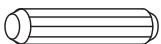



30 x12pcs



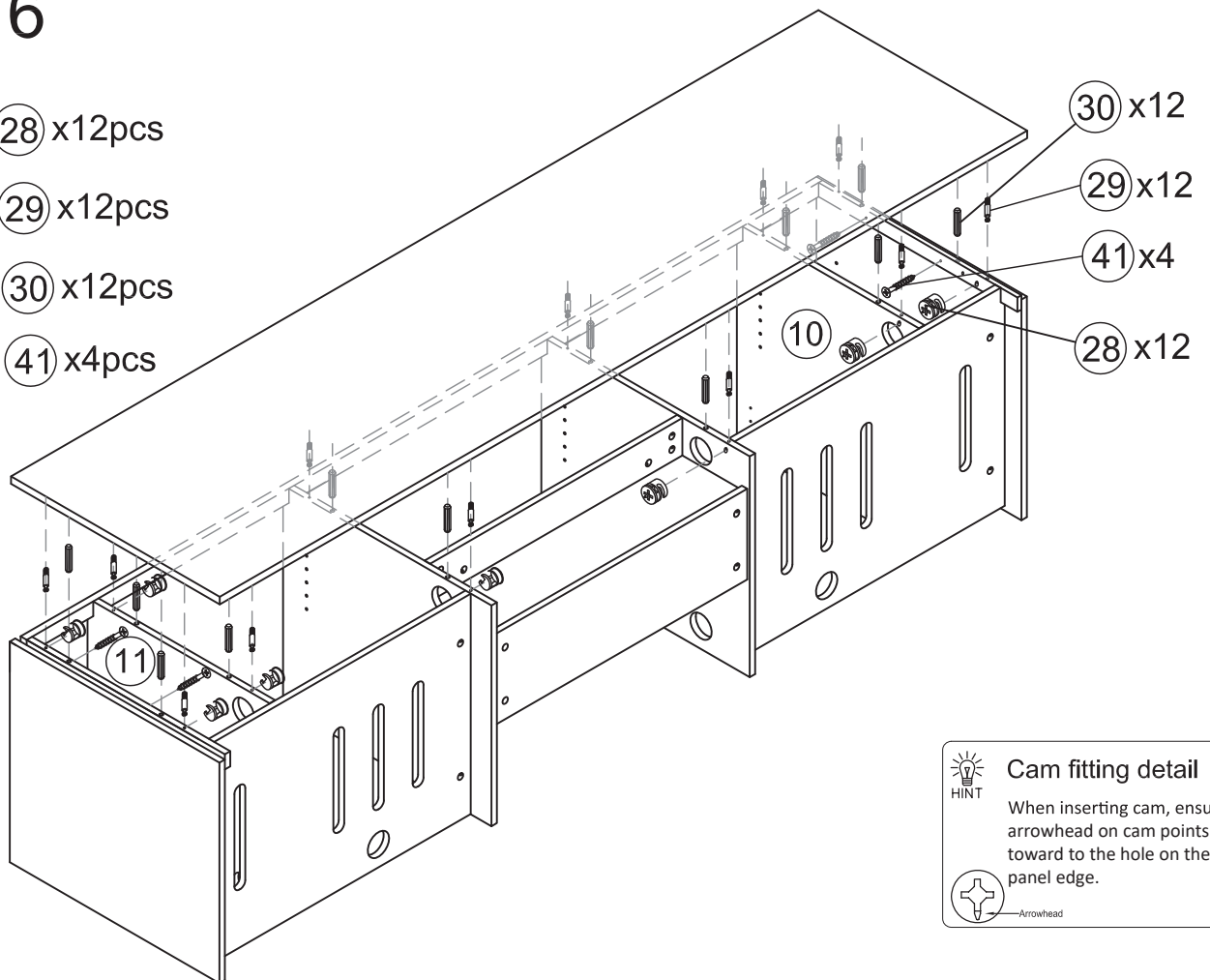

41 x4pcs



 **Cam fitting detail**
 HINT When inserting cam, ensure arrowhead on cam points toward to the hole on the panel edge.

 Arrowhead

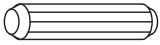
STEP 7

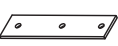
-  (30) x12pcs
-  (31) x12pcs
-  (34) x4pcs
-  (38) x2pcs

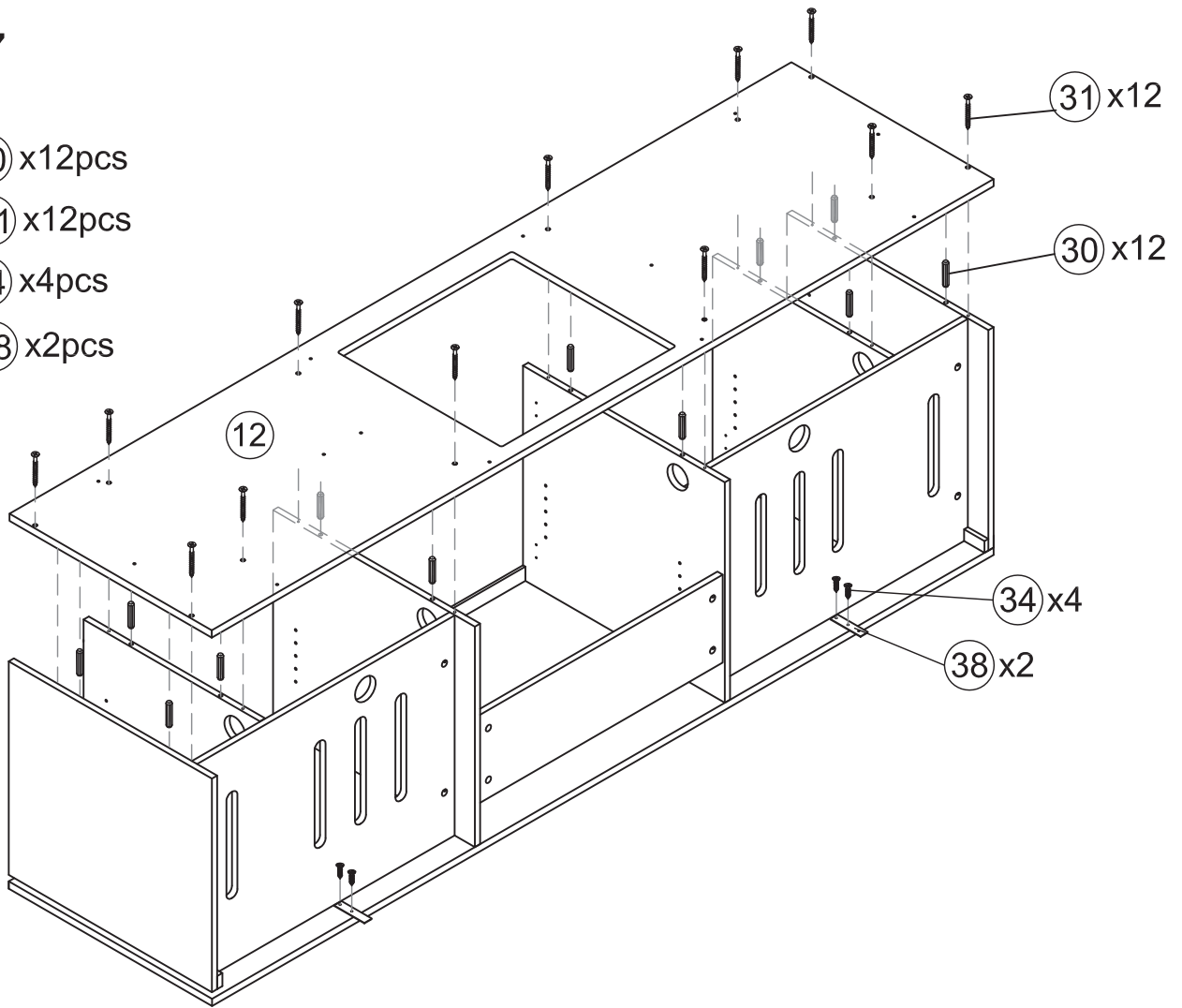

STEP 8

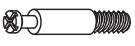
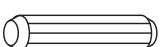
-  (28) x8pcs
-  (29) x8pcs
-  (30) x8pcs

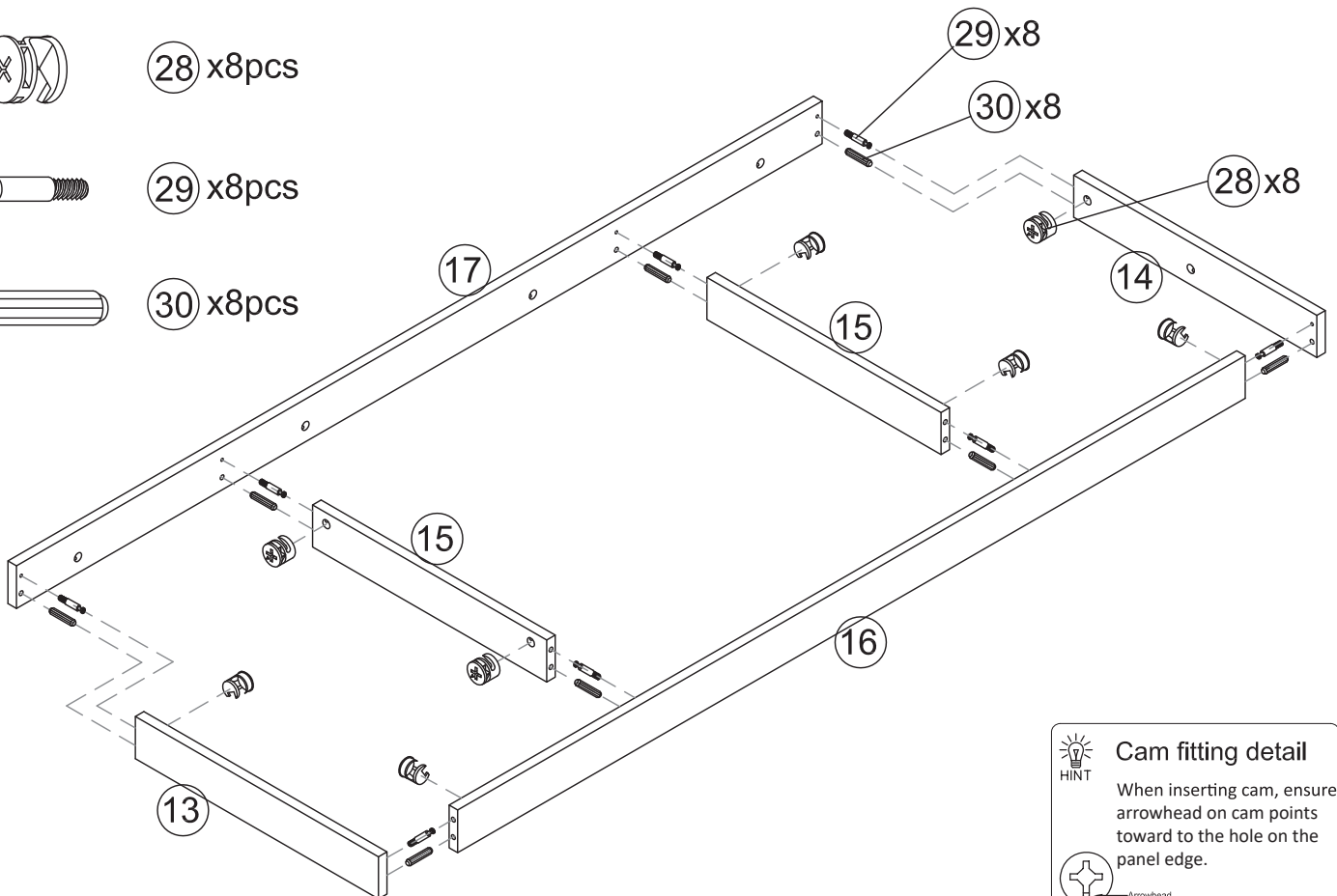

 **HINT** **Cam fitting detail**

When inserting cam, ensure arrowhead on cam points toward to the hole on the panel edge.

 Arrowhead

STEP 9



28 x12pcs

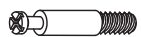

29 x12pcs

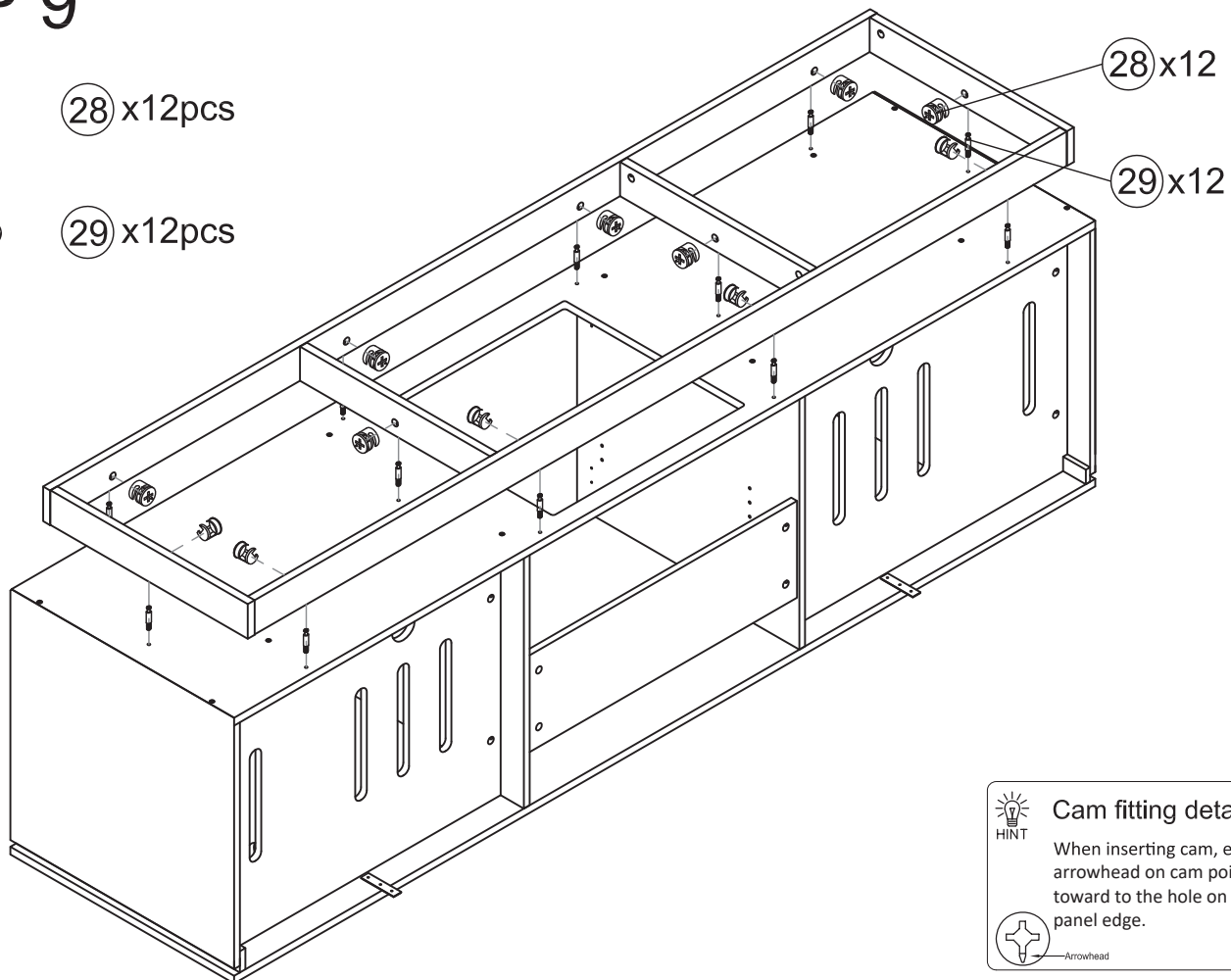

HINT

Cam fitting detail

When inserting cam, ensure arrowhead on cam points toward to the hole on the panel edge.



Arrowhead

STEP 10



33 x20pcs

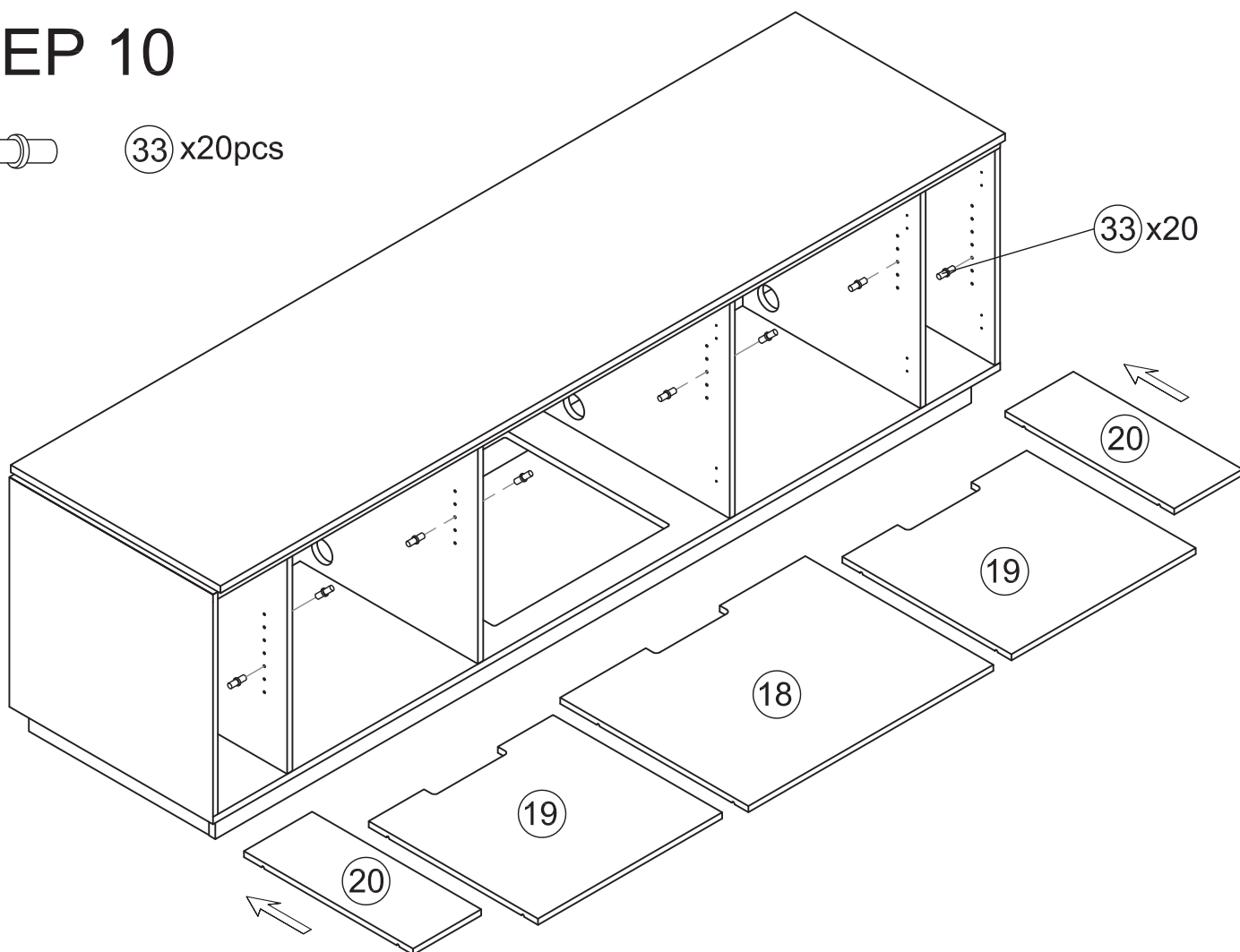

STEP 11



34 x60pcs

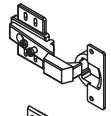

36 x6pcs

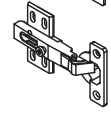

35 x4pcs

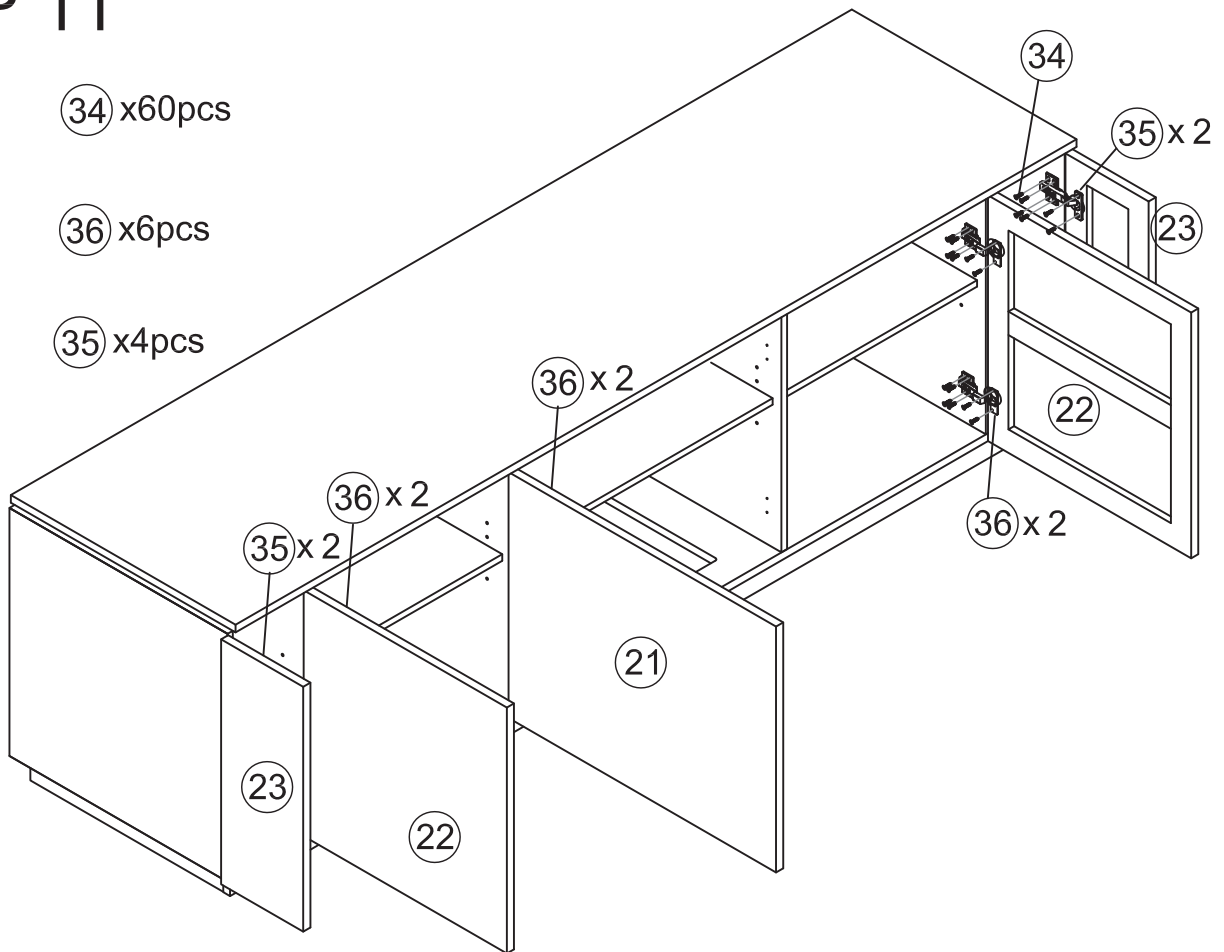

STEP 12



37 x2pcs

NOTE: For gyprock walls ensure you locate the studs, or use appropriate fixings to attach the straps to the wall. (also see Step 13)

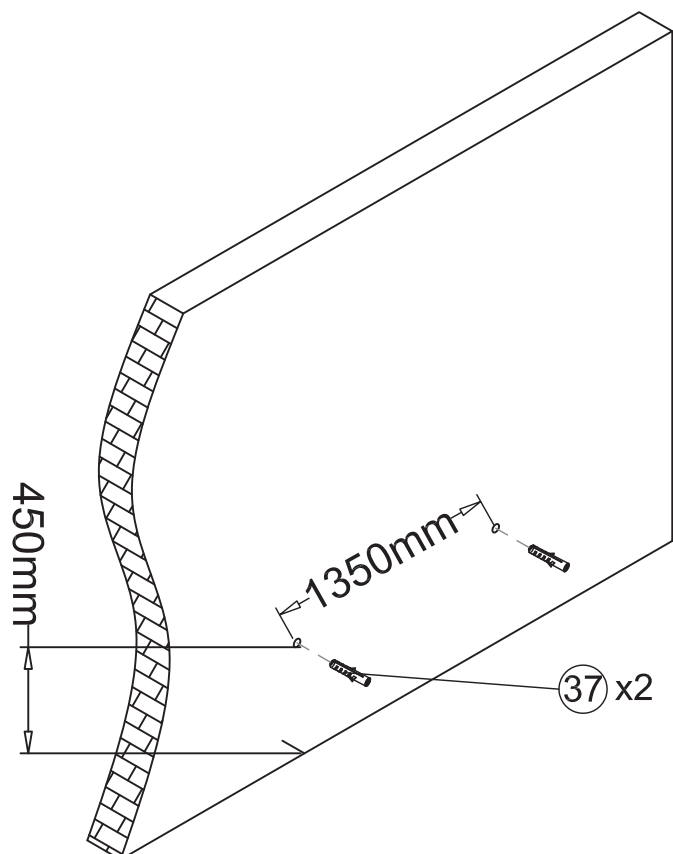

STEP 13

 31 x2pcs

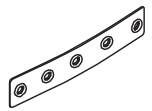
 39 x2pcs



Use a screw driver to fasten the screws (Part 31) into the wall.

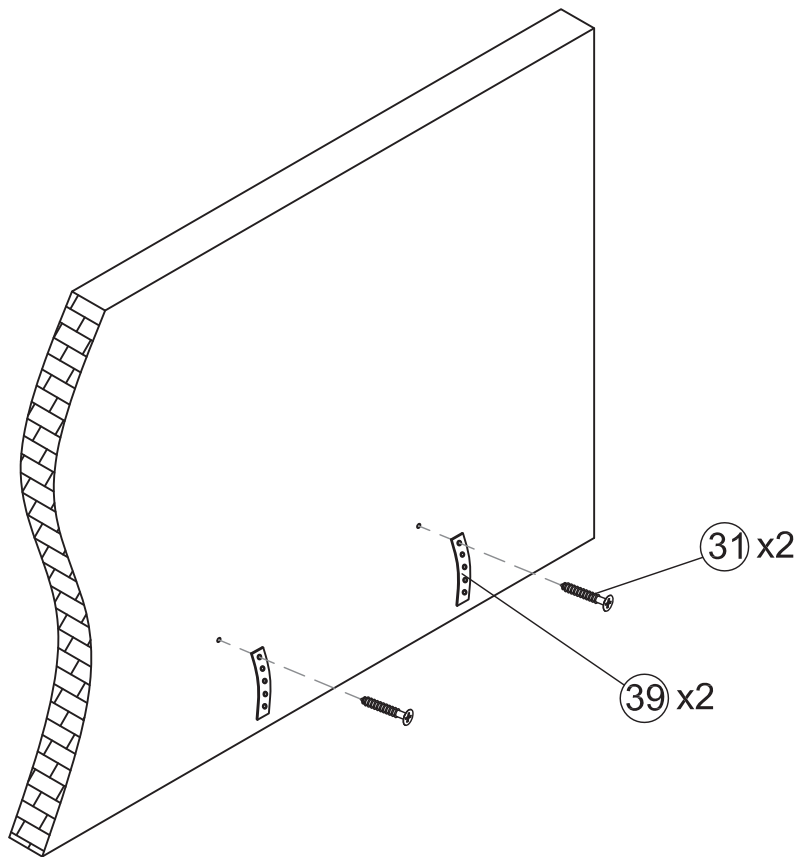

STEP 14

 40 x2pcs



Use a screw driver to fasten the screws (Part 40) into the bracket.

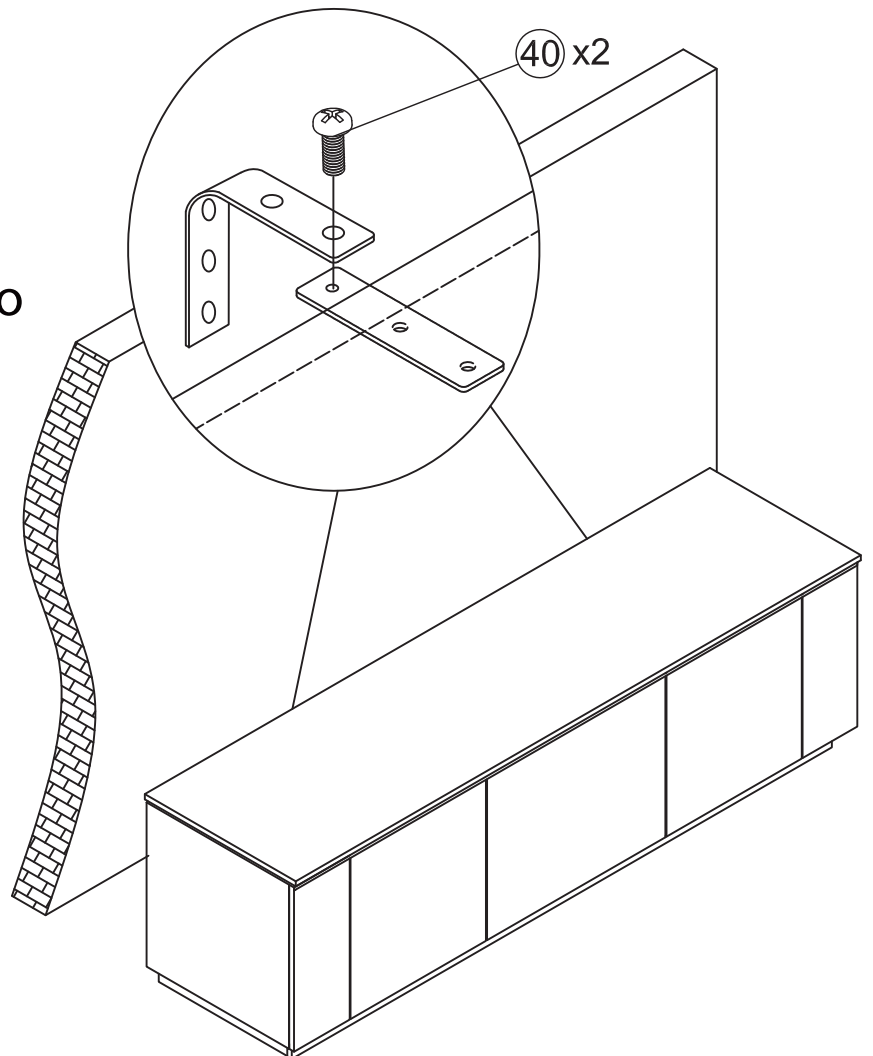



TAURIS

SURFACE CARE INSTRUCTIONS

A little care and attention will extend the life and good looks of your furniture. Take care when using materials which might spill, or be sharp or abrasive, on the surface of your furniture.

Normal Cleaning For normal cleaning use a soft, dry, clean cloth.

Glass Cleaning for Frosted Glass Do not use glass cleaner or solvent based cleaners on the surface of the glass that has the frosting effect on it.

Normal Glass Cleaning You may use normal glass cleaning products on all other types of glass. Use a soft non-abrasive cloth to remove light dust and finger prints.

Vinyl and Cloth Cleaning Under no circumstances should any abrasive materials be used on this surface, as it will result in unreparable damage.

Do not use solvents, solvent based cleaners, scouring pads, steel wool, furniture wax or scrubbing brushes.

Only use a slightly damp, soft, clean cloth on this surface if cleaning is needed. Do not scrub.

CAUTION

As with all furniture, this unit should not be exposed to direct sunlight, extreme temperatures or moisture, as this can result in non-reparable damage.

Note: The sooner a spill or mark is cleaned, the easier it will be removed.

Customer Service

FOR ALL MISSING OR FAULTY PARTS: PLEASE RE-CHECK YOUR PACKAGING TO ENSURE THAT PARTS ARE MISSING THEN CONTACT THE STORE YOU PURCHASED THE ITEM FROM.

THE STORE WILL NEED THE FOLLOWING INFORMATION.....

- COPY OF YOUR PURCHASE SLIP/RECEIPT
- MODEL NUMBER OF THE UNIT PURCHASED
- DESCRIPTION/PART NUMBER OF THE MISSING OR FAULTY PART
- QUANTITY OF THE PARTS NEEDED

If for whatever reason you cannot get in contact with the store, please get in contact with Tauris direct at <http://www.rvm.com.au/contact/>

Product of RVM Australia

11 Tamara Drive, COCKBURN CENTRAL

Perth, Western Australia 6164

PH: 08 9417 9944



WARRANTY POLICY

1. Nothing in this Warranty affects the Consumer's rights under the Australian Consumer law. The benefits to the Consumer under this Warranty are in addition to the rights and remedies of the buyer under any Consumer Guarantees. The Australian Consumer Law requires that we confirm that:

Our goods come with guarantees that cannot be excluded under the Australian Consumer Law. You are entitled to a replacement or refund for a major failure and for compensation for any other reasonably foreseeable loss or damage. You are also entitled to have the goods repaired or replaced if the goods fail to be of acceptable quality.

2. Subject to Clause 1, the Seller warrants that **TAURIS** branded products will be free of manufacturing defects and will perform to the Seller's specifications subject to the following clauses.

3. The benefit of this 12 Month Warranty extends only to the owner of the property in which the Products manufactured or supplied by the Seller are installed and used by the owner for the duration of the Warranty Period.

4. If within the Warranty Period a manufacturing defect is discovered in the Product, or the Product fails to perform to the Seller's specifications as a result of some defect in material or workmanship, then the Seller will replace or repair the goods under Warranty or refund the purchase price paid by the consumer (except if the failure is a major failure)

5. The Warranty does not apply to Product that:

- a.) Has failed due to excessive wear and tear beyond what is considered to be reasonable.
- b.) Has been misused or neglected.
- c.) Has been damaged accidentally or by acts of God including fire and flooding.
- d.) Has been used or operated contrary to operating or maintenance instructions.
- e.) Has been damaged in transit from the Sellers store to the buyer, either by the buyer or a third party authorised to act for the buyer.
- f.) Was incorrectly assembled or installed

6. In order to make a claim under the Warranty, the Owner must provide proof of purchase in all cases.

7. The seller will examine any returned Products and if the Seller determines that there is an apparent defect through no fault of the Owner, the Seller will:

- a.) Make note of the Owner's contact details including the Owner's telephone number which the owner can be contacted during business hours, postal address and e-mail address.

This Warranty is Supplied by : RVM Australia Pty Ltd

STRONG - SAFE - SECURE

www.rvm.com.au



- b.) Make note of the defects reported by the Owner.
 - c.) Take back the defective goods from the owner and determine within a reasonable time through dialogue with the Seller whether the goods are defective.
 - d.) Advise the owner within a reasonable time frame whether it accepts or rejects the Product claim.
 - e.) If the Seller accepts the return of the Product, the Seller must arrange to have
 - i) The Product repaired or,
 - ii) Replace the damaged or faulty Product or,
 - iii) Refund the purchase price
8. The Seller will not accept any returned Product which has not been returned strictly in accordance with this Warranty.
9. For the purpose of this Warranty:
- a.) Australian Consumer Law means the law as set out in Schedule 2 of the Competition and Consumer Act 2010 (Cth).
 - b.) Consumer means the Purchaser of goods from the seller.
 - c.) Consumer means a Consumer as that term is set out in section 3 of the Australian Consumer Law.
 - d.) Consumer Guarantees means the guarantees under the Australian Consumer Law.
 - e.) Implied terms means any guarantees, conditions, warranties, or other terms implied by any Australian Commonwealth, State or Territory laws, (excluding the Australian Consumer Law) or the law of any other jurisdiction.
 - f.) Owner has the meaning set out in clause 3.
 - g.) Warranty means this warranty.
 - h.) Product means the Product/s bought by the Owner from the Seller that fall under this warranty.
 - i.) Warranty Period means:
 - i) In relation to Furniture: 12 months Limited Warranty