

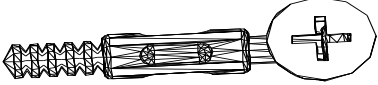





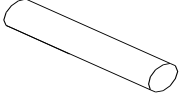
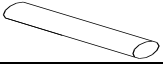

## Steps and tips of GX946 two doors shoe cabinet – black and white

Hardware list				
	shape	description	size	Qty
A		Black plastic screw + large round buckle	34	32
B		Silver metal screw + small round buckle	18	12
C		Big cork	Φ 8*40	2
D		Small cork	Φ 6*30	4
E		Flathead hinge screws	Φ 4*10	36
G		Plastic cover of the holes	Φ 60	2
H		Two-stage slide rail	L250	2
I		Straight Hinge	straight	4
J		Shelf nail	Φ 5	12
K		Thick lines screws	Φ 7*40	3
L		Anti-friction plastic nail (Bottom)		8

## Steps and tips of GX946 two doors shoe cabinet – black and white

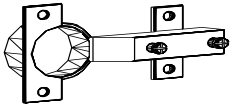
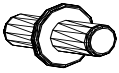

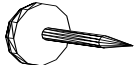
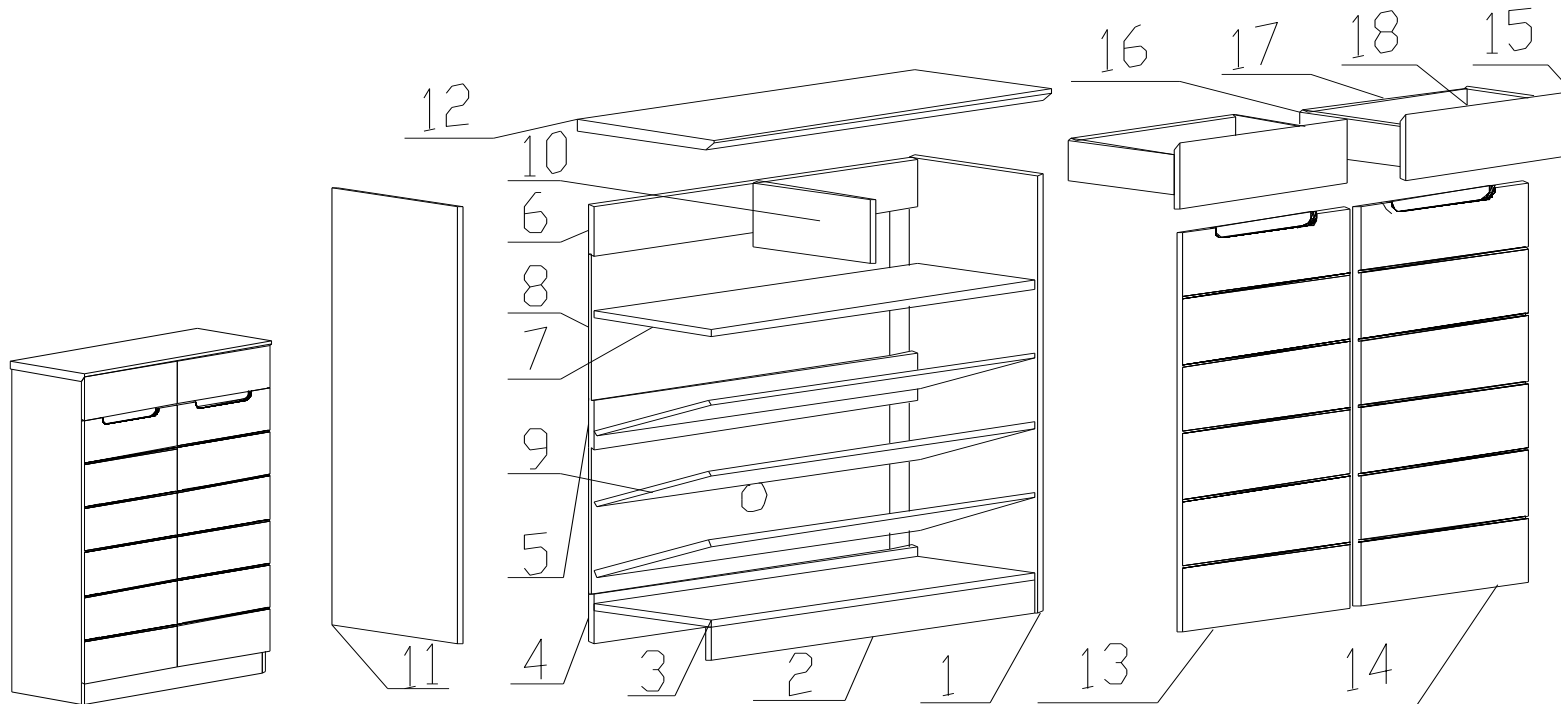
No.	Name	No.	Name	No.	Name	No.	Name
1	Left side panel	6	Upper back bar	11	Right side panel	16	Drawer - right
2	Front bar	7	Fixed shelf	12	Roof panel	17	Drawer - back
3	Bottom panel	8	Thin back board	13	Right door	18	Drawer - front
4	Lower back bar	9	Flexible shelves	14	Left door		
5	Middle back bar	10	Drawer support panel	15	Drawer - left		

Preparation:

Take all the parts out of boxes, and sort them by their shapes. **Please use some material to protect the surface of all panels.**

Steps:

1, The first step is to install the side panels. Putting the 2 side panels on the ground and installing all the screws(Part A & C), then you can start. **All the Screws need to be installed tightly that its threaded metal parts need to be put in holes thoroughly.**



2, the second step is to installing three back bars. Pay attention to three different back bars, their holes should face backward.

Steps and tips of GX946 two doors shoe cabinet – black and white

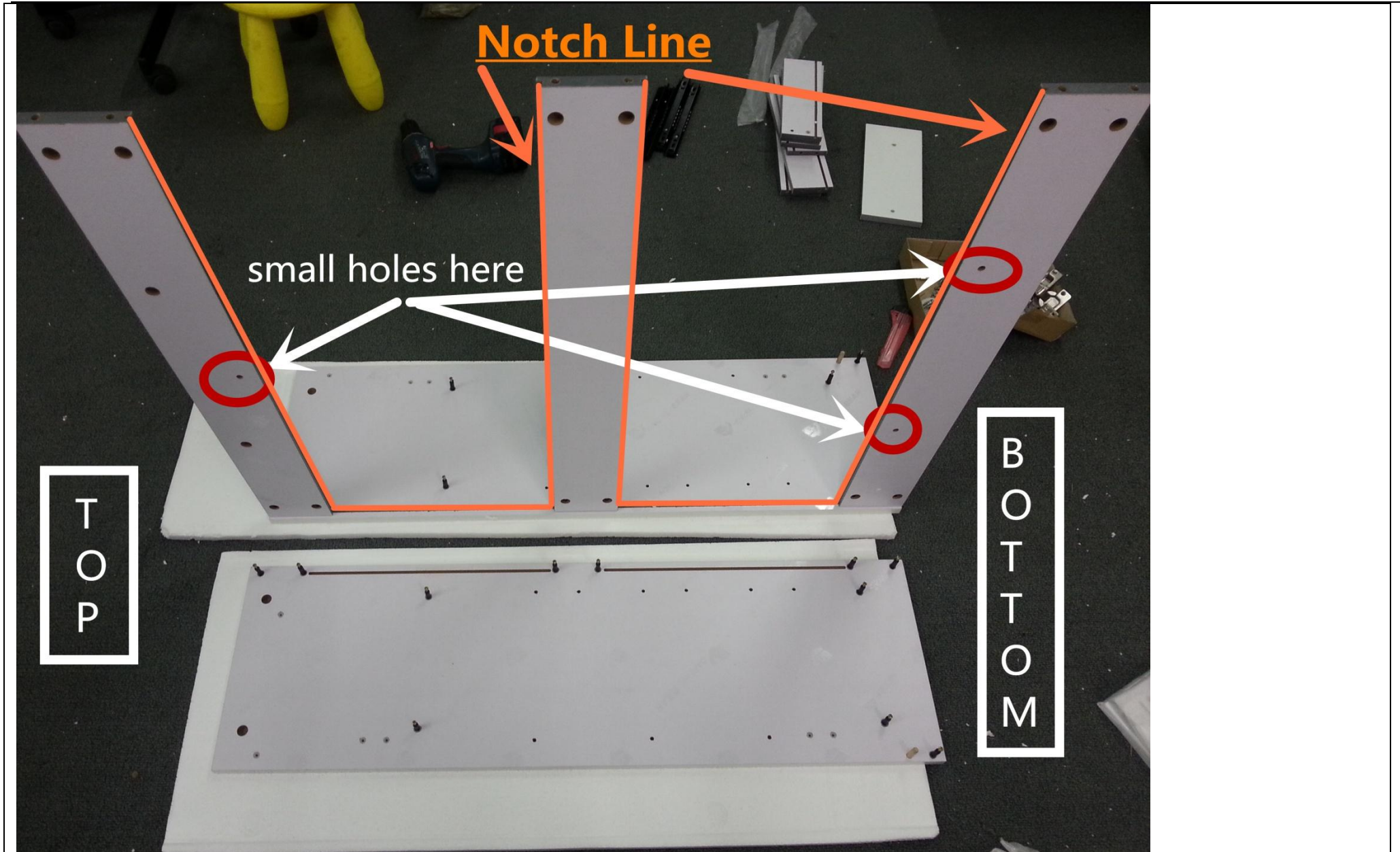

Steps and tips of GX946 two doors shoe cabinet – black and white

3, the third step is assembling the fixed shelf and the bottom. Their holes should face to the bottom.



4, the fourth step is assembling 2 thin back boards. Put PART G up, then pay attention to put the thin board into the notch of back bars and notch of side panel.

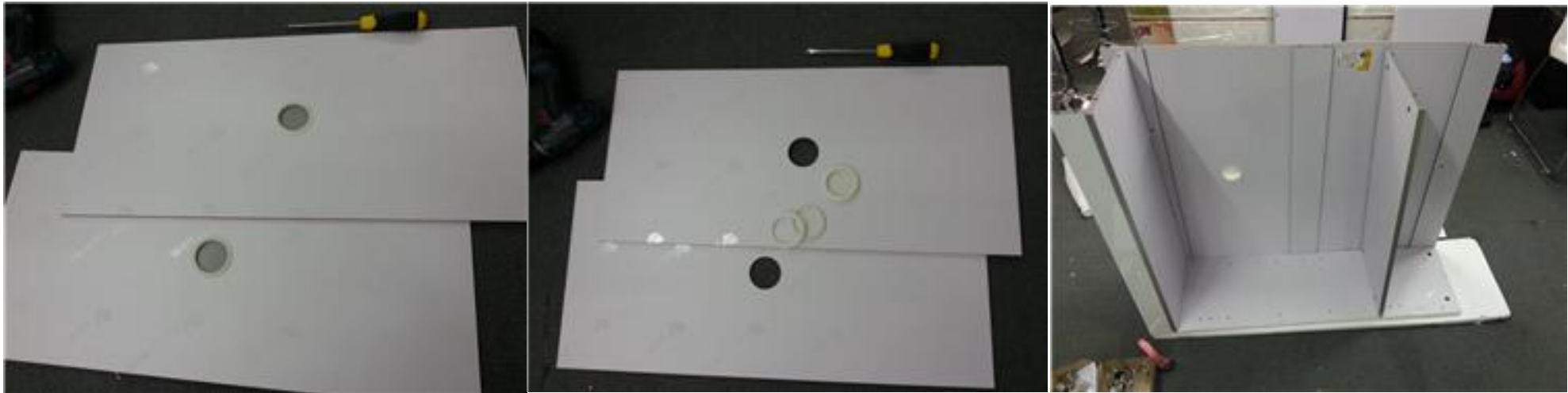



Steps and tips of GX946 two doors shoe cabinet – black and white

5, the fifth step is to install the other side panel and to tight all screws by using part A & K. It will use a lot of the big round buckles. DO NOT miss the holes underneath and those holes of fixed shelf.



5, the fifth step is to install PART L to the bottom by using hammer, then put the shoe cabinet bottom to the ground.



Steps and tips of GX946 two doors shoe cabinet – black and white

6, the sixth step is to install drawer support panel by using part A, there is a small hole on the side of the small panel, which should face to the back. Tight all the parts A & K.

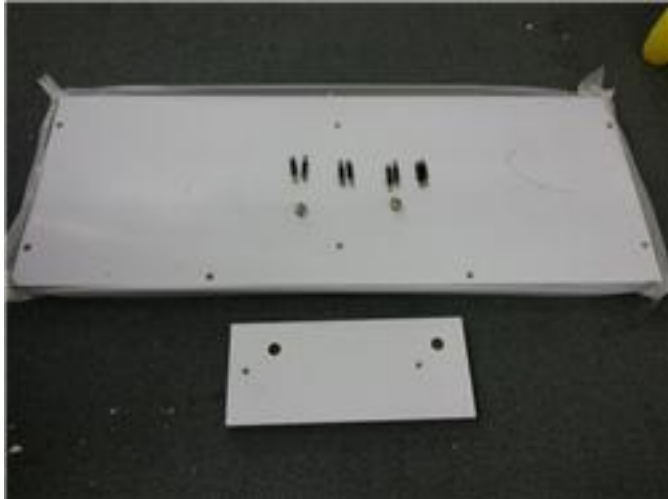

7, the seventh step is to install drawers by using parts B&D.

Steps and tips of GX946 two doors shoe cabinet – black and white

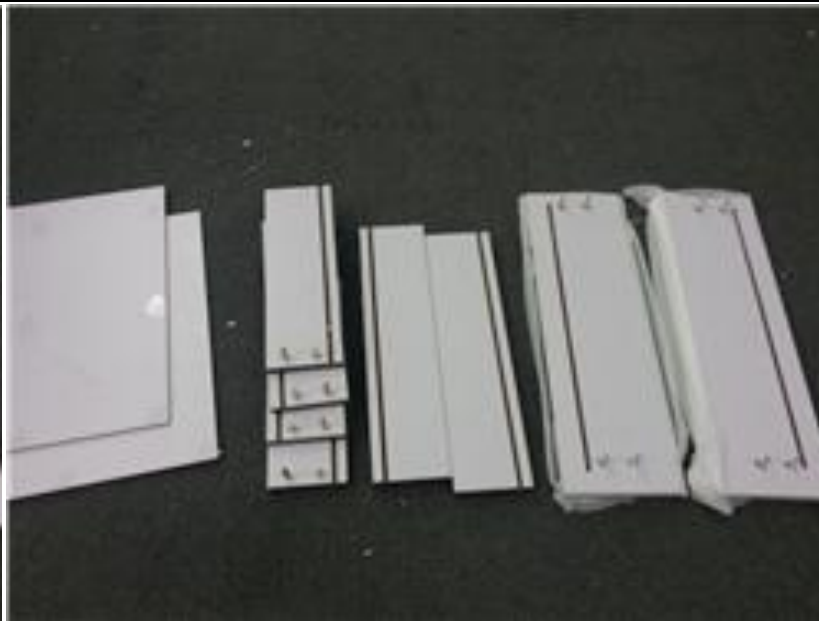



8, the eighth step is to separate PART H and put them up on the both side of drawers. Stretch part H as long as you can, then push the plastic part aside, and you can gradually remove the first stage. After that, install the first stage of part H on the drawers by using part E.

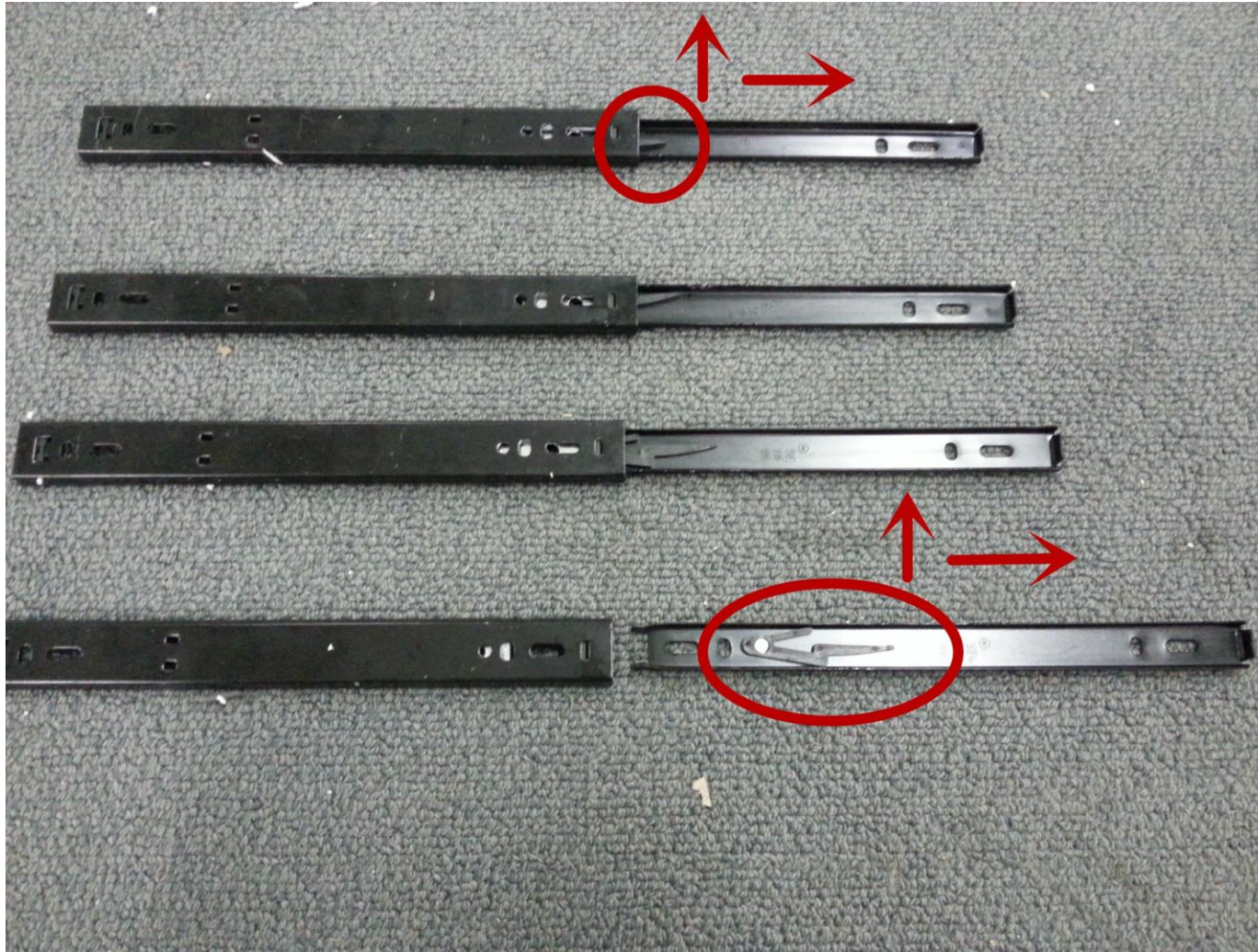

Steps and tips of GX946 two doors shoe cabinet – black and white

9, The ninth step is to install the rest of Part H on the side panels and drawer support. Then put the drawers into the tracks. If your first attempt is unsuccessful, you can repeat the eighth step, remove the drawers and adjust part H and try again.



10, The tenth step is to put 3 flexible shelves which are without any holes into the cabinet by using part J.



Steps and tips of GX946 two doors shoe cabinet – black and white

11, the eleventh step is to fix hinge in the doors by using part E & I . Put books or other material under the bottom of doors to make it easier to assemble. After everything is done, adjust the screws on the hinges to adjust any gaps between doors and drawers.

